

Iridium GO!®

Fixed Installation Kit (WINSTKT1601)

Installation Guide



Prior to installing or using Iridium GO!, read and understand this Installation Guide, the Wall Mounting Instruction Guide and the Iridium GO! User Manual including the safety warnings and information. Failure to do so could result in serious injury or death.

Legal Notices

This Installation Guide provides installation information and is provided “as is.” Iridium and its affiliated companies, directors, officers, employees, agents, trustees or consultants (“Iridium”) assume no responsibility for any typographical, technical, content or other inaccuracies in this Installation Guide. Iridium reserves the right to revise this Installation Guide or withdraw it at any time without prior notice. You can find the current version of this Installation Guide for the Iridium GO! at www.iridium.com.

Your Iridium GO! Fixed Installation Kit contains Iridium Accessories subject to the 1 year Limited Warranty including Exclusions, Disclaimers, Limitations of Liability and Conditions of Use that is in the Legal Information Booklet that came with your Iridium GO!, and that is also available online at www.Iridium.com. Installation of the Iridium GO! Fixed Installation Kit does nothing to change or extend the original Limited Warranty on your Iridium GO! device itself. You are permitted to use Iridium GO! Fixed Installation Kit only as described and specified in this Installation Guide, the Iridium Go! User Manual, and the Limited Warranty. By using the Iridium GO! Fixed Installation Kit, you are indicating that you agree to comply with the terms set forth in this Installation Guide as well as the User Manual, including without limitation the Limited Warranty, including the section describing permitted use of Iridium GO! (the “Conditions of Use”). If you fail to comply with the Limited Warranty and the Conditions of Use, Iridium may void certain protections offered under the Limited Warranty and Iridium reserves the right to terminate your right to use the Iridium GO! on the Iridium system. If you do not accept the terms of the Limited Warranty and Conditions of Use, do not use the Iridium GO! Fixed Installation Kit.

If you do not have the Iridium GO! User Manual, it can be found at www.iridium.com or call 1-866-947-4348 (or +1-480-752-5155 for outside U.S.) and request that a User Manual be sent to you.

Third Party Information

This Installation Guide might refer to third party sources of information, hardware or software, products or services and/or third party web sites (“third party information”). Iridium does not control, and is not responsible for, any third party information, including without limitation the content, accuracy, copyright compliance, compatibility, performance, trustworthiness, legality, decency, links, or any other aspect of third party information. The inclusion of such third party information does not imply endorsement by Iridium of the third party information. ANY THIRD PARTY INFORMATION THAT IS PROVIDED WITH IRIDIUM’S FACILITIES, SERVICES, PRODUCTS OR USER INFORMATION IS PROVIDED “AS IS”. IRIDIUM MAKES NO REPRESENTATIONS, GUARANTEES OR WARRANTIES IN RELATION TO THIRD PARTY INFORMATION AND IRIDIUM SHALL NOT BE LIABLE FOR ANY LOSSES, DAMAGES, LIABILITIES, JUDGMENTS, AND FINES, AMOUNTS PAID IN SETTLEMENT, EXPENSES OR COSTS OF DEFENSE SUSTAINED IN RELATION TO ANY SUCH THIRD PARTY INFORMATION.

Intellectual Property, Trade Secret, Proprietary or Copyrighted Information

To protect Iridium proprietary and confidential information and/or trade secrets, this Installation Guide may describe some aspects of Iridium technology in generalized terms. Iridium products may include copyrighted Iridium and third party software. Any such copyrighted software contained in Iridium products may not be modified, reverse engineered, distributed or reproduced in any manner to the extent provided by law. The purchase of any Iridium products shall not be deemed to grant either directly or by implication or otherwise, any license under copyrights, patents, or patent applications of Iridium or any third party software provider, except for the normal, nonexclusive, royalty free license to use that arises by operation of law in the sale of a product.

Content Copyright

You are exclusively responsible for the use of Iridium GO! Fixed Installation Kit, including proper use of third party copyrighted materials. If you violate these terms, you agree to defend, indemnify and hold Iridium harmless with respect to any claims or actions by third parties related to your improper use of copyrighted material and to pay all costs, damages, fines and other amounts incurred by Iridium, or on its behalf, in the defense of any such claims or actions.

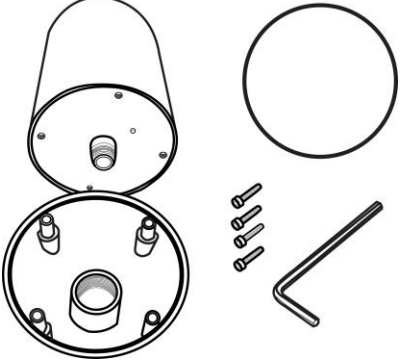
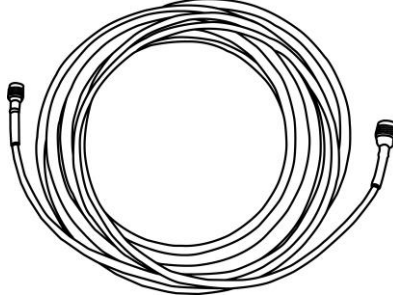
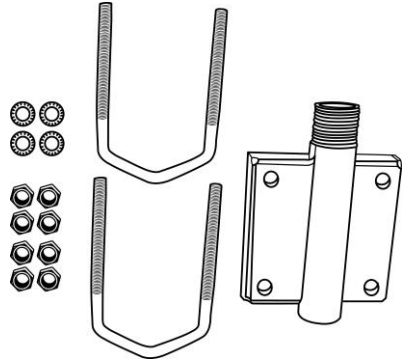

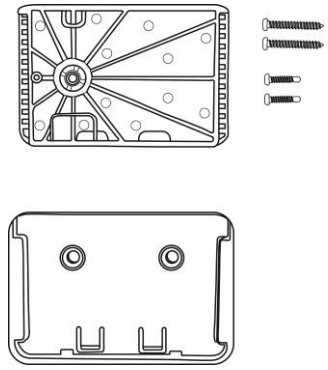



Table of Contents

1 Kit contents	4
1.1 Items included in kit:	4
2 Antenna and Cable Installation.....	5
3 Wall Mount Bracket Installation.....	8
4 RAM® Mount Installation.....	8
5 Specifications.....	9
5.1 Iridium Passive Omnidirectional Antenna	9
5.2 Mast/Rail Mount 1"-14NF.....	10
5.3 Wall Mount Bracket.....	10
5.4 12m/39ft Passive Antenna Cable.....	11
5.5 Iridium GO! Cable Adapter	11

Iridium GO! Fixed Installation Kit



1 Kit contents

1.1 Items included in kit:

		
<p>(A) 1 x Iridium Passive Omnidirectional Antenna Kit (PN: BMGKANT)</p>	<p>(B) 1 x 12m/39ft Passive Antenna Cable (PN: BMGKCBL12)</p>	<p>(C) 1 x Stainless Steel Mast/Rail Mounting Bracket Kit (PN: BMGKANTBRKT)</p>
		
<p>(D) 1 x RAM® Mount with Threaded Adapter (PN: BMGKRAM224)</p>	<p>(E) 1 x Wall Bracket Kit (PN: WBKT1301)</p>	<p>(F) 1 x Iridium GO! Cable Adapter (PN: WAAC1301)</p>
		
<p>(G) 10 x Cable Ties (PN: BMGKCBLT)</p>	<p>(H) 1 x User Installation Guide (PN: WINSTKTUG1601)</p>	

2 Antenna and Cable Installation

Note: It is recommended that prior to installation, pre-test the complete set up. This can be done on a bench or on the deck of the boat. Connect all components to test if everything works fine. Doing so will familiarize the user how the parts go together and guarantees it works fine prior to installation. Make sure the external antenna is located outside and the Iridium GO! receives good signal reception for at least 5 minutes during this test before you proceed with the installation. Maintain a separation of at least 20 cm (7.8 inches) from antenna during test.

⚠ WARNING	
	<p>Persons with Pacemakers:</p> <ul style="list-style-type: none"> Should ALWAYS keep Iridium GO! and the antenna more than eight inches from their pacemaker when the device is turned ON. Should turn Iridium GO! OFF immediately if there is any reason to suspect that interference is taking place. Failure to heed this warning could result in serious injury or death.
	<p>The Iridium GO! device utilizes a negative ground system. When using a DC power source, such as a car or boat, the power system must be a negative ground system. Do not use the device with positive ground systems. Failure to properly ground the GO! could cause fire or could cause the device to fail so that it is unavailable in an emergency situation, preventing or delaying an emergency response. These hazards could cause serious injury or death.</p>
	<p>Use the Iridium GO! device with Iridium supplied power accessories ONLY. Use of non-Iridium supplied power accessories could result in exposing the device to excessive voltage, which could cause fire or could cause the device to fail so that it is unavailable in an emergency situation, preventing or delaying an emergency response. These hazards could cause serious injury or death.</p>

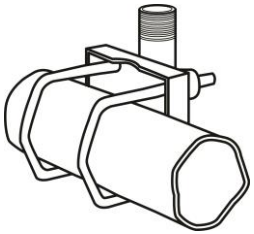
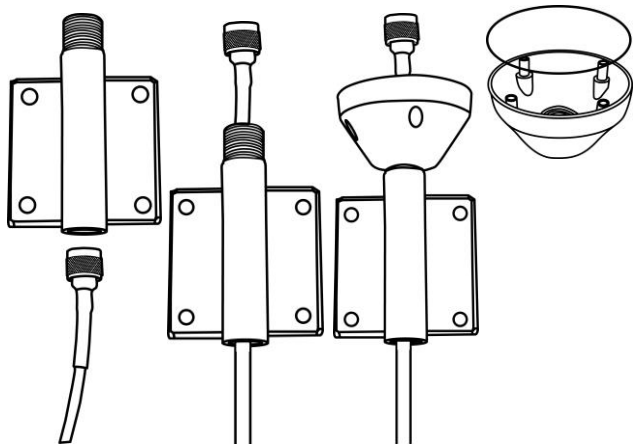
<p>Step 1)</p> <p>Find a dry location for Iridium GO! inside the vessel. Ensure that it is installed near a power source. See RAM Mount Installation on how to secure the Iridium GO! Device in the vessel (Section 4, pg. 8)</p>	<p>Step 2)</p> <p>Carefully consider the cable path to allow the cable length for the exterior antenna to reach the Iridium GO! device.</p>
<p>Step 3)</p> <p>Bracket mounting: Install the Mast/Rail mounting bracket within the 12 metre/39 feet proximity to a pole or rail.</p> <div style="display: flex; justify-content: space-around; align-items: center;"> <div style="text-align: center;">  <p>Vertical installation</p> </div> <div style="text-align: center;">  <p>Horizontal installation</p> </div> </div> <p>Antenna mounting The antenna must not be mounted at a location such that during radio transmission, any person or persons can come closer than the indicated minimum safe distance to the antenna: 20 cm (7.8 inches). See Iridium GO! User Manual for a discussion of exposure to radio frequency (RF) energy.</p> <p>Note: U-Bolts can fit pole and rail with diameter 30-60mm.</p>	<p>Step 4)</p> <p>Once the antenna mount bracket is securely in place feed the Type N end of the cable through the base of the bracket then, feed the cable through the Antenna base plate. Ensure that you attach the black rubber seal provided to the antenna base plate.</p> <div style="text-align: center;">  </div>

Iridium GO! Fixed Installation Kit

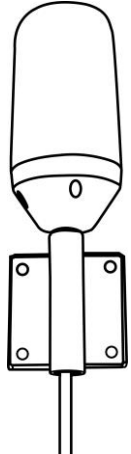
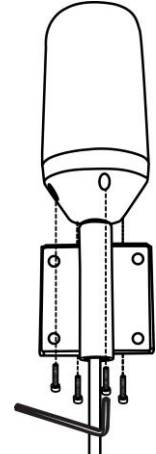
<p>Step 5)</p> <p>Connect the antenna cable and hand-tight the connector to the antenna.</p> 	<p>Step 6)</p> <p>Screw the antenna base to the antenna housing using screws and Allen key provided.</p> 
--	--

Note:

- 1) Use of an external antenna will provide connectivity for the Iridium network only, but will not provide GPS reception. In order to obtain GPS reception, the Iridium GO! device itself is required to have a direct line of sight of the sky with a 7 degree view above the horizon.
- 2) To ensure maximum performance of the antenna and to maximize availability and reliability of service, the position of the antenna must:
 - a. have clear line of site to sky
 - b. be clear and free of obstructions
 - c. be clear of metal objects
 - d. be located above and away from other transmitting devices
 - e. be securely affixed in location
 - f. not be located indoors
 - g. be installed in conjunction with a certified included cable.

(show line of sight image of vessel and position of antenna)

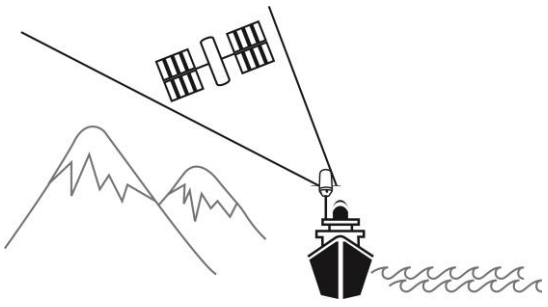

Step 7)

To minimise cable from waving around, use the cable ties provided to fasten tight along the pole or rail path and at both the antenna end and the Iridium GO! end. It is important that cable ties are used at the Iridium GO! end to tighten the cables and cable adapter to the RAM mounting bracket.

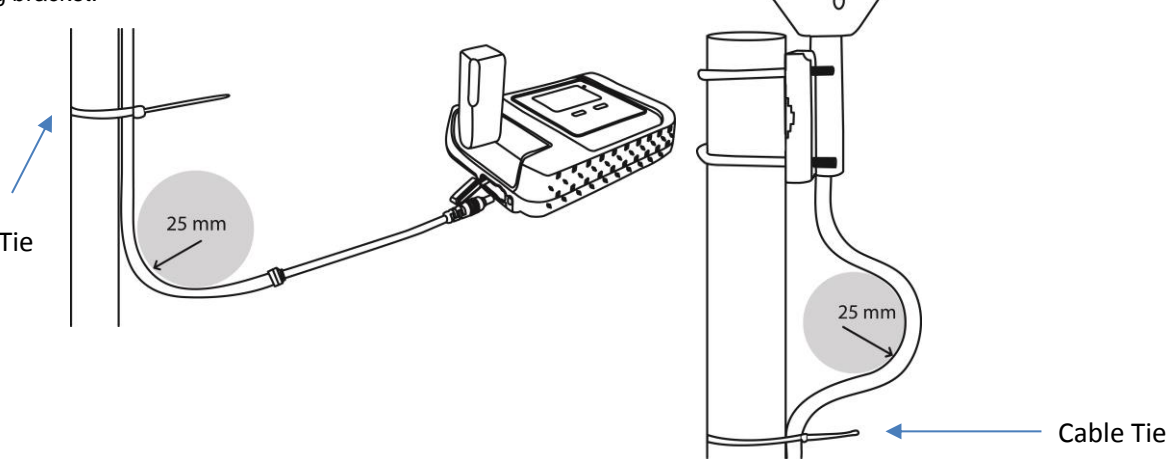

Iridium GO! Fixed Installation Kit

Note:

- 1) Do not put stress on the cable. Ensure that the bend radius of the cable doesn't go below 25mm slack (see 5.4 Passive Antenna Cable Physical Specifications).
- 2) When installing the antenna cable, follow these guidelines:
 - a. route and restrain cables to prevent them from vibrating or moving under normal conditions which could result in damage to the antenna or the coaxial cable connections.
 - b. wherever the cables contact structures, protect the cables from chafing or abrasion. If a cable needs to be bent, avoid kinking it, and ensure that each bend radius follows the cable supplier limits.
 - c. use coaxial sealant, shrink-wrap tubing, electrical tape or another suitable product to seal all cable connections appropriately to prevent moisture and corrosion damage from weather exposure. Mount all antennas vertically and clear of nearby metal obstructions. Minimise horizontal obstructions as much as possible because this can create areas of poor system coverage.

Step 8)

Connect the TNC end of the cable to Iridium GO! adapter. The connector on the device is located behind the cover found directly below the device antenna.

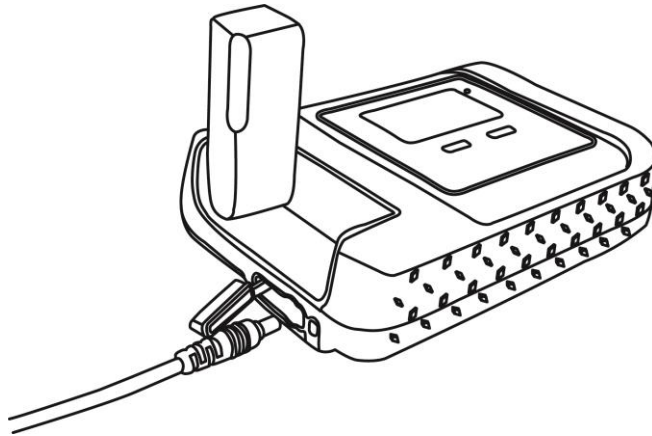

Note:

- 1) When an external antenna is connected, you must still raise the device antenna; this action turns the unit on and allows for transmission with the Iridium network, while lowering the device antenna can disable transmission or effectively switch the device off.
- 2) Please use provided cable ties to secure the antenna cable to the RAM mount.

⚠ WARNING



Do not leave power and antenna ports uncovered. Open power cover only for as long as recharging is required, and open antenna cover only when actively using the external antenna. Leaving the covers open allows moisture and water vapor to enter the device which in turn could lead to corrosion and damage to the device. This could cause fire or could cause the device to fail so that it is unavailable in an emergency situation, preventing or delaying an emergency response. These hazards could cause serious injury or death.

3 Wall Mount Bracket Installation

Note: Please refer to the Instruction Manual provided enclosed in the Wall Mount Kit.

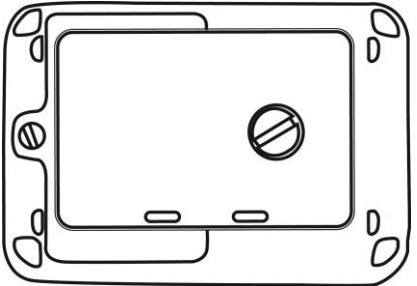
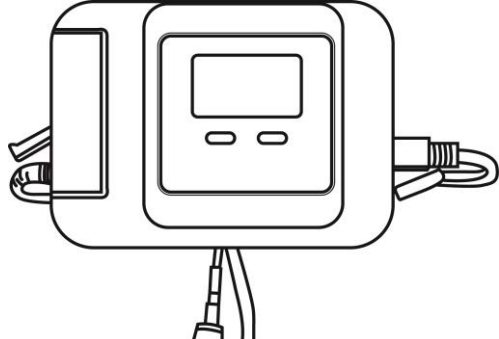
	
<p>(A) Complete installation set up of Wall Bracket at the back of Iridium GO! Device</p>	<p>(B) View of the cables (Antenna and USB) from the front, using the Wall Bracket when mounted on a flat surface.</p>

4 RAM® Mount Installation

To keep the Iridium GO! Device securely in place, install the RAM Mount provided.

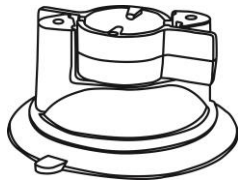

A - 3.3" Suction Cup Twist Lock Base



B - Stainless Steel Metal Screws x 2

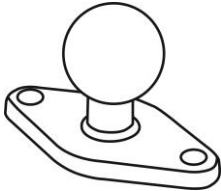

C - 1" Ball, Diamond Base w/ Post



D - 1" Ball Round Plate with 1/4" - 20 Camera

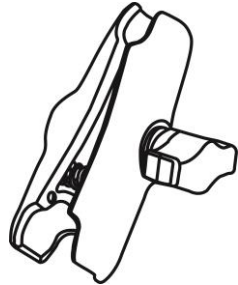

E - Double Socket Arm

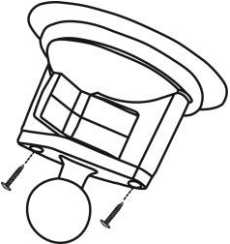
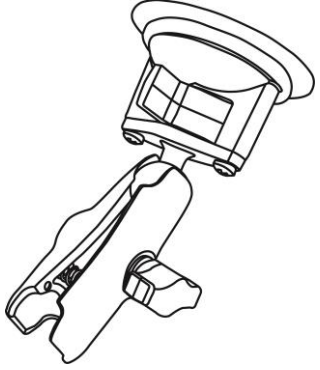
<p>Step 1)</p> <p>Align the 1" ball, diamond base (C) on top of suction cup base (A) and fasten with two screws (B).</p> 	<p>Step 2)</p> <p>Loosen knob on double socket arm (E) and attach to assembled unit in Step 1.</p> 
--	--

Iridium GO! Fixed Installation Kit

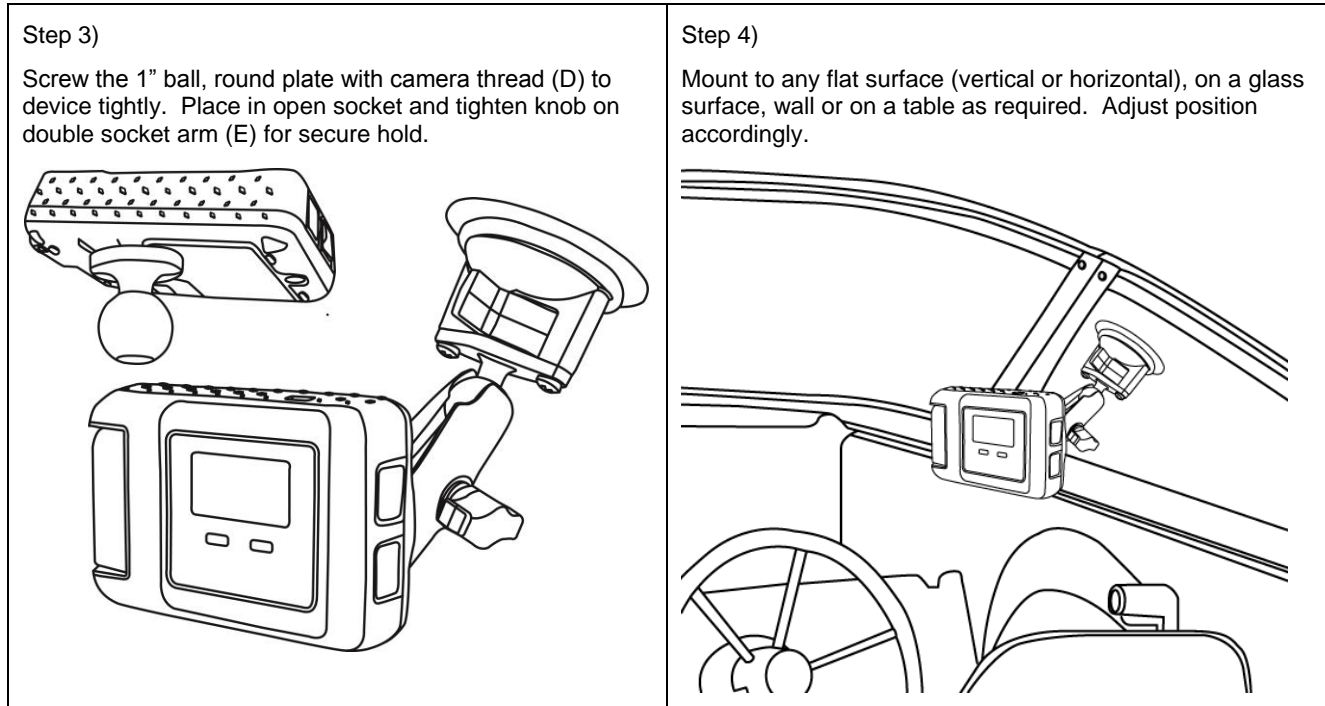

5 Specifications

5.1 Iridium Passive Omnidirectional Antenna

Certified passive Iridium Antenna for use with the Iridium GO!

- Requires no pointing towards satellite
- Low loss radome

Electrical Specifications:	
Frequency	1616 - 1626.5 MHz (L-band)
Impedance	50 ohm
VSWR	< 1.5
Satellite System	Iridium
Polarisation	RHCP
Axial Ratio	< 6 dB
Gain	2 dBic

Iridium GO! Fixed Installation Kit

Mechanical Specifications:	
Color	White (non-glossy)
Height	150 mm (191.5 mm mounting base included)
Diameter	Ø 95 mm
Mounting	Supplied Mounting or any US-style Mounting Bracket with 1"-14NF thread.
Mounting place	On marine vessel or land based vehicle
Materials	ASA, copper, PCB, stainless steel and brass
Operating temperature	-40C to +85C
Connector	N-female
Cable	See 12m/39ft cable specifications

5.2 Mast/Rail Mount 1"-14NF

Stainless Steel Mast/Rail Mounting Bracket 1"-14NF

Mechanical Specifications:	
Color	Polished
Mounting	On pole or rail with supplied U-bolts
Mounting place	On vertical or horizontal pole or rail with diameter Ø 30-60 mm
Materials	Polished high grade AISI-316 stainless steel
For Antenna Types	Supplied Iridium Marine antenna
Dimensions	130 x 92.5 x 40 mm

5.3 Wall Mount Bracket

Mechanical Specifications:	
Color	Black textured MT11010 surface
Mounting	On wood or metal surface with bracket puck plate and screws
Mounting place	Vertical or horizontal on wall or flat surface
Materials	Hard Plastic
Screws	¼ inch (9560 mounting plate) M4 PANPOZI head x 20mm for Metal M4 PANPOZI head x 30mm for Wood
Dimensions	9560 Mounting Plate – 85mm x 57mm x 5.45mm Wall Bracket – 90.25mm x 59.90mm

Iridium GO! Fixed Installation Kit

5.4 12m/39ft Passive Antenna Cable

Electrical Specifications:	
Impedance	50 Ω
Capacitance	77.1 pF/M (23.5 pF/ft)
Velocity of Propagation	85%
Voltage Withstand	2500 VDC
Max Operating Frequency	11.0 GHz

Physical Specifications:	
Bending Radius Static	25mm (1.0")
Bending Radius Repeated	103mm (4.0")
Weight	1.2kg
Connectors	TNC-M (Iridium GO!) N-M (Iridium Antenna)
Cable diameter	10.29mm
Cable Diameter	19.95mm

Environmental Specifications:	
Operating Temperature	-40°C to +85°C

5.5 Iridium GO! Cable Adapter

Physical Specifications:	
Connectors	TS9 (Iridium GO!) TNC-F (Iridium Antenna)
Cable Length	15cm / 6"

For Customer Support, please contact:

Beam Communications Pty Ltd

US Office (Toll Free): +1 800 250 5819

UK Office: +44 208 144 1405

International: +61 3 8588 4500

Email: support@beamcommunications.com

©Copyright 2016 Iridium Satellite LLC and its affiliates. All rights reserved.

08/16

Iridium®, Iridium GO!® and the Iridium Logo are registered trademarks of Iridium Satellite LLC and its affiliates ("Iridium"). All other trademarks, service marks and logos are the property of their respective holders, which have not been endorsed, sponsored or otherwise affiliated with Iridium or Iridium GO!.

WINSTKTUG1601