

Intellian[®]

FB150

Installation and Operation Manual

Serial number of the product

This serial number will be required for the all troubleshooting or service inquiries.

Intellian[®]

© 2017 Intellian Technologies Inc. All rights reserved. Intellian and the Intellian logo are trademarks of Intellian Technologies, Inc., registered in the U.S. and other countries. All other logos, trademarks, and registered trademarks are the property of their respective owners. Information in this document is subject to change without notice. Every effort has been made to ensure that the information in this manual is accurate. Intellian is not responsible for printing or clerical errors.

REGULATORY INFORMATION	4
INTRODUCTION	6
OVERVIEW OF THE FLEETBRODBAND SYSTEM	8
MAIN UNITS	9
INSTALLATION	14
Installation of ADU	15
Installation of BDU	20
Installation of Primary Handset	21
Connections	23
GETTING STARTED	26
System configuration	26
Preparation for Operation	27
USING THE PRIMARY HANDSET	31
USING THE WEB CONSOLE	65
TROUBLESHOOTING	127
TECHNICAL SPECIFICATION	133

REGULATORY INFORMATION

FEDERAL COMMUNICATION COMMISSION NOTICE

FCC Identifier: QO4-AVIFX150BDE

USE CONDITIONS:

This device complies with part 15 of the FCC Rules. Operation is subject to the following two Conditions:

1. This device may not cause harmful interference, and
2. This device must accept any interference received, including interference that may cause undesired operation.

NOTE:

This equipment has been tested and found to comply with the limits for a Class B digital device, pursuant to Part 15 of the FCC Rules. These limits are designed to provide reasonable protection against harmful interference in a residential installation. This equipment generates uses and can radiate radio frequency energy and, if not installed and used in accordance with the instructions, may cause harmful interference to radio communications. However, there is no guarantee that interference will not occur in a particular installation.

If this equipment does cause harmful interference to radio or television reception, which can be determined by turning the equipment off and on, the user is encouraged to try to correct the interference by one of the following measures:

- Reorient or relocate the receiving antenna.
- Increase the separation between the equipment and receiver.
- Connect the equipment into an outlet on a circuit different from that to which the receiver is connected.
- Consult the dealer or an experienced radio/TV technician for help.

IMPORTANT NOTE: EXPOSURE TO RADIO FREQUENCY RADIATION

This Device complies with FCC & IC radiation exposure limits set forth for an uncontrolled environment. The Antenna used for this transmitter must be installed to provide a separation distance of at least 100cm from all persons and must not be co-located or operating in conjunction with any other antenna or transmitter.

FCC CAUTION:

Any Changes or modifications not expressly approved by the manufacturer could void the user's authority, which is granted by FCC, to operate this satellite Fleet-Broadband System FB 150.

INDUSTRY CANADA STATEMENT:

IC: 5023B-AVIFX150BDE

This device complies with Radio standard specification RSS -170 of Industry Canada Rules. Operation is subject to the following two conditions:

1. This device may not cause harmful interference, and
2. This device must accept any interference received, including interference that may cause undesired operation.

IMPORTANT NOTE: Radiation Exposure Statement

This equipment complies with IC radiation exposure limits set forth for an uncontrolled environment. This antenna used for this transmitter must be installed to provide a separation distance of at least 100cm from all persons and must not be co-located or operating in conjunction with any other antenna or transmitter.

EC Declaration of Conformity:

Intellian Technologies, Inc., 348-5 Chungho-ri, Jinwi-myeon, Pyeongtaek-Si, Gyeonggi-do, Korea 451- 862 declares

under our sole responsibility that the accessory Product, brand name as Intellian and models:

FB 150 FleetBroadband satellite communication system, to which this declaration relates, is in conformity with the following standards and/or other normative documents:

RoHS2 Directive 2011/65/EU

ETSI EN 301 444, ETSI EN 301 489-1, -19 & -20, IEC 60945 / EN 60945,

IEC 60950-1 AND EN 60950-1, ITU-R M.1480

We hereby declare that all essential radio test suite have been carried out and that the above named product is in conformity to all the essential requirements of Directive 1999/5/EC.

The Conformity Assessment procedure referred to Article 10 and detailed in Annex [III] or [IV] of Directive 1999/5/EC has been followed with involvement of the following notified body (ies):

TIMCO ENGINEERING Inc., P.O BOX 370, NEWBERRY, FLORIDA 32669. Identification mark: 1177 (Notified Body number)

1. INTRODUCTION

The FB150 FleetBroadband Terminal is a dedicated compact solution specifically designed to meet the FleetBroadband (FBB) services for the maritime environment providing seamless ocean coverage from 76° North to 76° South. FBB is the marine version of the highly successful BGAN (Broadband Global Area Network) from Inmarsat.

Through a maritime BGAN antenna, it provides constant, simultaneous access to voice and high-speed data in a compact solution. Allowing you to run online operation systems, and still having access to email, intranet and voice calls - achieving greater operational efficiencies and significantly reducing the cost of both business and crew communications.



Note: Radome dimension can be vary by different matching dome option.

1.1 Range of Service

- Email and webmail
- Secure communications
- Intranet and internet access
- SMS and instant messaging Videoconferencing and streaming
Phoneand fax services
- Large file transfers

1.2 Features

The FB150 offers the following features

Service	FB150
Coverage	Voice, fax and data are available globally except for the extreme polar regions
Voice	4kbps AMBE + 2 3.1KHz Audio (above 20° elevation)
Fax	Group 3 fax via 3.1 KHz Audio (above 20° elevation)
SMS	Standard 3G (up to 160 characters) per SMS. Maximum of 4 chained SMS.
Data	Standard IP : Up to 150 Kbps

The UE has built-in Web Console, allowing you to manage your phone book, messages and calls, and customize the terminal to your specific needs.

1.3 Interfaces

The FB 150 UE has the following connecting interfaces:

- +12V / 24V DC Power Input Connector
- Antenna Connector (ADU : N-Type, BDU : TNC-Type)
- SIM Card Slot for FBB SIM card
- Dedicated Primary Handset port
- I/O Port
- GPS Output Port

The number of RJ45 Ethernet ports and RJ11 ports for the BDUs of the FB 150 is illustrated below:

RJ45 Ethernet Ports for PC and router	2 LAN Ports (PoE)
RJ11 Phone	Yes
RJ11 Fax	Yes

2. OVERVIEW OF THE FLEETBROADBAND SYSTEM

BGAN Services

The Broadband Global Area Network (BGAN) is a global Satellite Internet Network using portable terminals. The terminals are usually connected to a laptop computer to access broadband Internet in remote locations, where a line-of-sight to the satellite exists. The user can make phone calls, access the Internet, check e-mail, download files, or perform any other Internet activity using the terminals. The network is provided by Inmarsat and uses three geostationary satellites called I-4 to provide almost global coverage.

The map below shows the three I-4 satellite coverage regions.

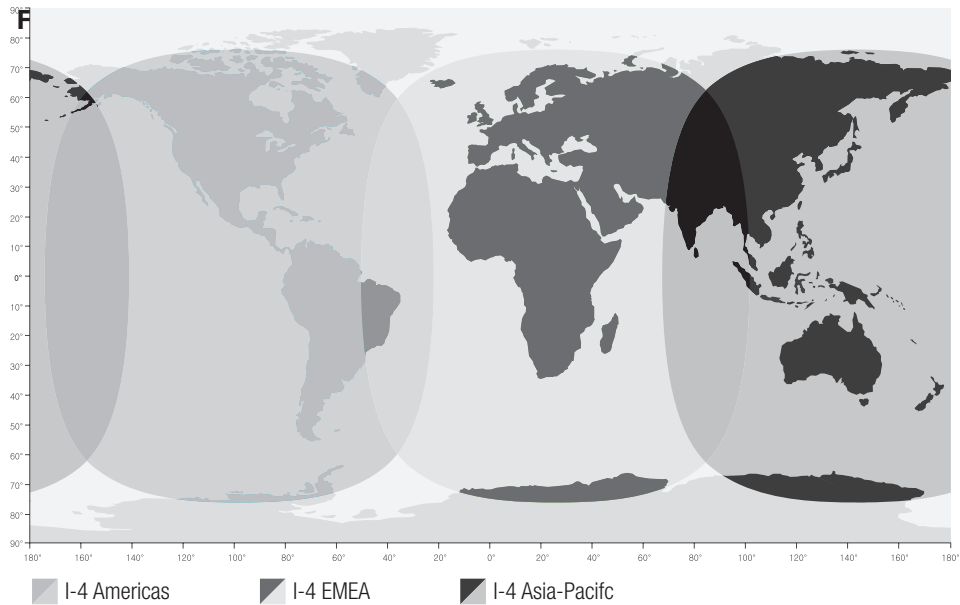

This map depicts Inmarsat's expectations of coverage, but does not represent a guarantee of service. The availability of service at the edge of coverage areas fluctuates depending on various conditions.

Note: The above map depicts Inmarsat's expectations of coverage, but does not represent a guarantee of service. The availability of service at the edge of coverage areas fluctuates depending on various conditions.

3. MAIN UNITS

The FB 150 FleetBroadband system include the following main units:

- FB 150 FleetBroadband BDU
- FB 150 FleetBroadband ADU
- Primary Handset

3.1 Above Deck Unit (ADU), the antenna unit

The FB series ADU is Maritime FleetBroadband 3-axis controlled antenna. The antenna is self-tracking based on patented beam squint technology. The simple and robust electromechanical system, with one motor per free axis, provides full coverage in azimuth and elevation. Tracking is accomplished by measuring signals being continuously broadcast from the satellite.

The radome covers the antenna equipments, which is composed of:

- Antenna Unit (N-Type)
- RF and GPS circuit
- Rotary joint
- Antenna pedestal

The antenna unit includes LNA (low noise amplifier), HPA (high power amplifier) and tracking receiver circuitry to ensure communication even in adverse circumstances.



All signals (and DC power) shall pass through a single coaxial antenna cable, which connects the ADU to the BDU.

3.2 Below Deck Unit (BDU)

The BDU has been developed for maximum flexibility and is the controlling unit for the FBB UE. It features a reliable industry standard interfacing field and enables users to have optimal connectivity no matter what the conditions or your position at sea.



The BDU has a built-in Web Console, which can be accessed from a computer connected to the BDU, using an Internet browser. The Web Console provides easy configuration of the BDU, firmware upgrade and daily use. For more information, see Chapter 8, using the Web Console.

The BDU is supplied by a +12V or +24V DC power supply, and it supplies power to the ADU via a single RF/coaxial antenna cable.

Status LEDs



There are 3 Status LEDs to indicate the operational status of the BDU at one glance.

Each LED is assigned to the following function:

- BDU Terminal Status
- ADU Status
- Registered to Network Status

SIM Card Slot



The BDU has a SIM (Subscriber Identity Module) card slot located at the connector panel behind a small cover plate. The UE requires a dedicated FBB SIM card to access the FBB network and configure the settings of the UE.

Front panel

The following diagram shows the front panel of the BDU.

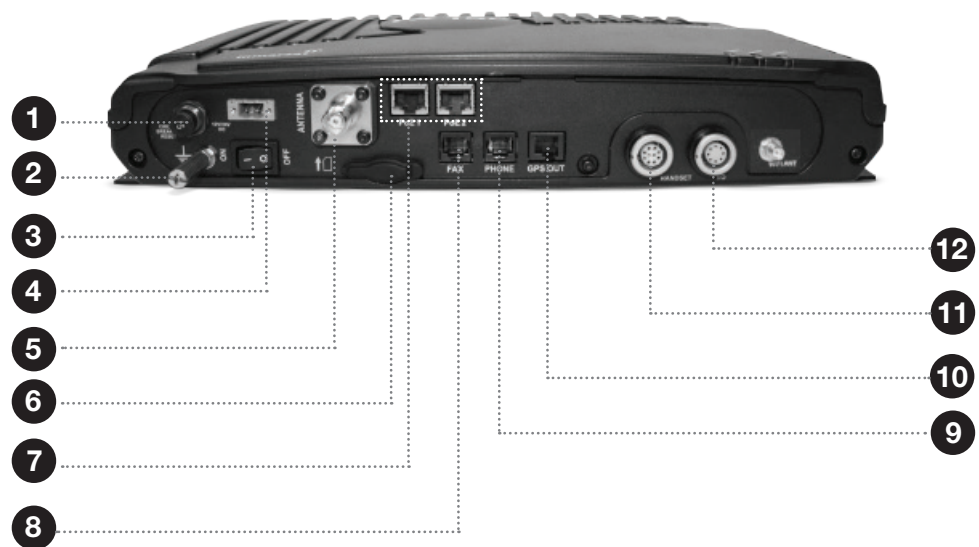

1. Resettable Circuit Breaker
2. Grounding Stud
3. Power Switch
4. DC Power Connector
5. Antenna (TNC-Type) Connector
6. SIM Card Slot
7. PoE Ports (RJ45)
8. Fax Port (RJ11)
9. Phone Port (RJ11)
10. GPS Output Port
11. Primary Handset Port
12. GPIO Port

3.3 Primary Handset



The wired Primary Handset has a colour LCD and keypad for making and receiving voice calls and sending SMS using an interface similar with a mobile phone. It can serve as a remote access for user to access various BDU functions. The Primary Handset connector is plugged into the BDU primary handset port and it is powered directly from the BDU.

4. INSTALLATION

4.1. USER EQUIPMENT LISTS

FB150 Complete Standard Package

Description

- FB150 Terminal

FB150 Standard Accessories

Description

- FB150 FleetBroadband Primary Handset
- Ethernet Cable (1.5m)
- Telephone Cord (1.8m)
- Handset Wall Mount Cradle
- Power Cable (1.8m)
- GPIO Cable 8-pin (1m)
- LMR240 Antenna Coaxial Cable (15m)

FB150 Installation Kit

Description

- Hex. Bolt x 7 (M6 x 35L)
- Hex. Bolt x 7 (M6 x 50L)
- Spring Washer x 7 (M6)
- Flat Washer x 7 (M6)

Note: Installation Kit components could be changed depending on matching dome option.

E.g. FB150 with Intellian i4 radome

- Hex. Bolt x 5 (M8x35L)
- Spring Washer x 5 (M8)
- Flat Washer x 5 (M8)

Coaxial Cable Type	Attenuation (dB/100m)	Attenuation (dB/m)	Recommended Cable Length (m)
LMR 240	33.6	0.336	25m
LMR 400	17.5	0.175	50m
LMR 600	11.3	0.113	85m

4.1 Installation of ADU

Planning the Installation

Install the antenna in accordance with the following procedures to ensure maximum performance of the antenna. The antenna should be installed in a place where it has an all-around clear view of the horizon. Please be sure there are no obstacles within 15 degrees above the antenna. Any obstacles can prevent the antenna from tracking the satellite signal (Refer to the drawing on the right).

Do not install the antenna near by the radar especially on the same plane as their energy levels may overload the antenna front-end circuits. It is recommended to position the antenna at least 4 feet (1.2m) above or below the level of the radar and minimum of 15 feet (6m) away from the high power short wave radars. The mounting platform should be rigid enough and not subjected to excessive vibration. The movement of the antenna can be minimized by installing at the center of the vessel. For optimal performance of the antenna, it is not recommended to install at any corner of the vessel, where the movement of the vessel is the greatest. Install the bottom of the antenna parallel to the surface of the sea and fix tightly to the structure of the vessel. When setting the antenna down, be careful not to damage the RF connector. Striking the connectors on the bottom directly will damage the connector.

Caution: Antenna MUST be mounted on a mast and NEVER mounted flat on a deck as water may enter the antenna through drain holes.

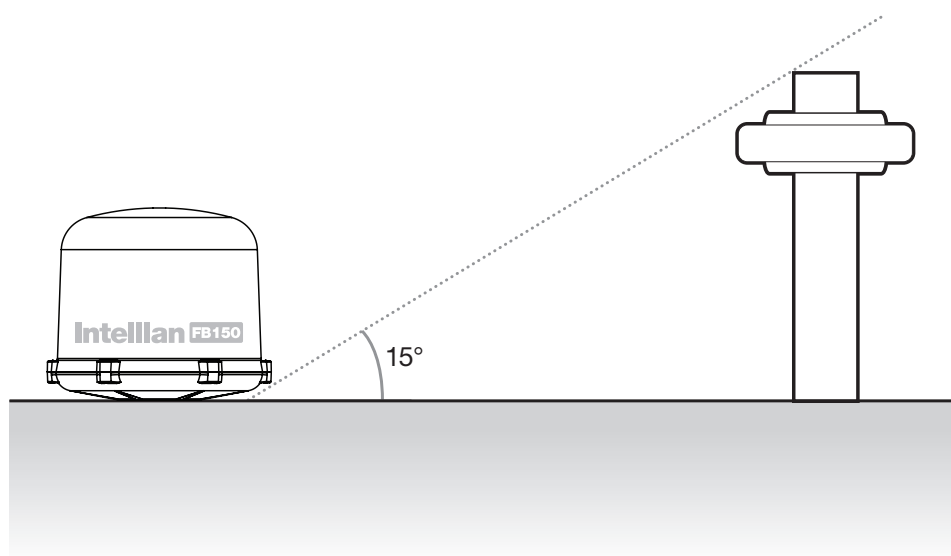

Installation and Mounting of Antenna

The method of installation and mounting of antenna may vary due to vessel design but the following procedures are applicable in most situations, and will result in a secure and effective installation.

Confirmation of Size Prior to Installation

- Check the height and diameter of the bottom surface of the antenna before installing.
- The space must be sufficient for installing the antenna unit considering the height and diameter of the antenna.
- The height and the diameter of the bottom surface of the antenna are as shown in the following drawing. If possible, install the antenna using a power tower.

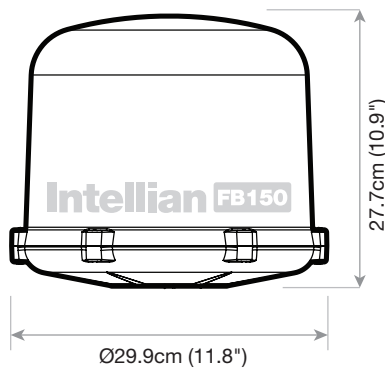

Radome Dimension of FB150 Standard

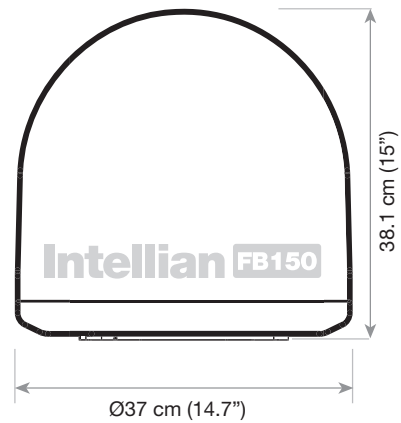

Radome Dimension of FB150 with Intellian i2 matching dome

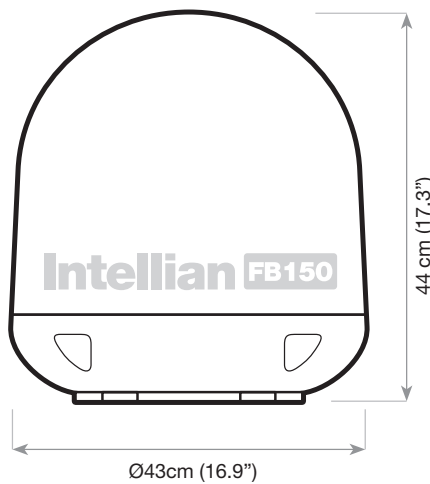

Radome Dimension of FB150 with Intellian i3 matching dome

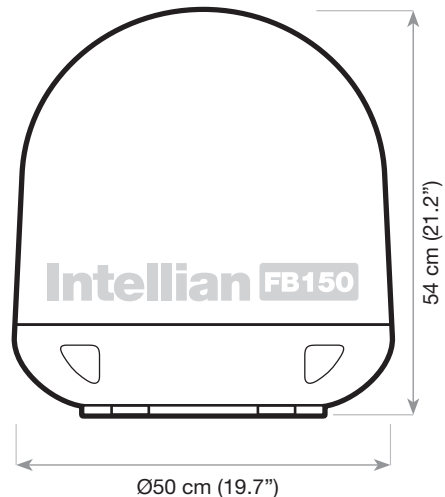

Radome Dimension of FB150 with Intellian i4 matching dome

Mark of the Antenna Mounting Position

Referring to the mounting template, mark where antenna will be mounted on board (it must be a flat surface) or on a separate power tower

Note: If a power tower is not suitable to mount the antenna, separate cable shock and waterproofing measures must be taken to protect the RF connector from being exposed to the sea water and external shocks. An exposed cable may cause electric shock and cause serious damage to the equipment.

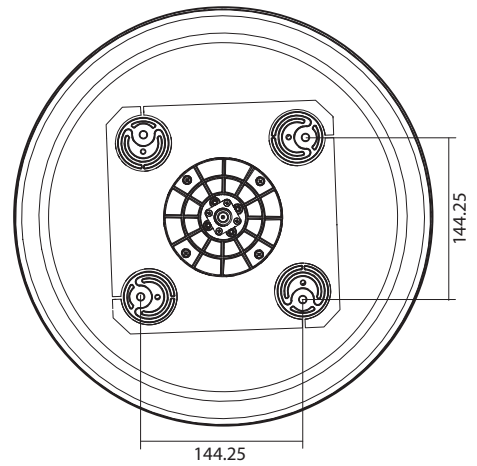
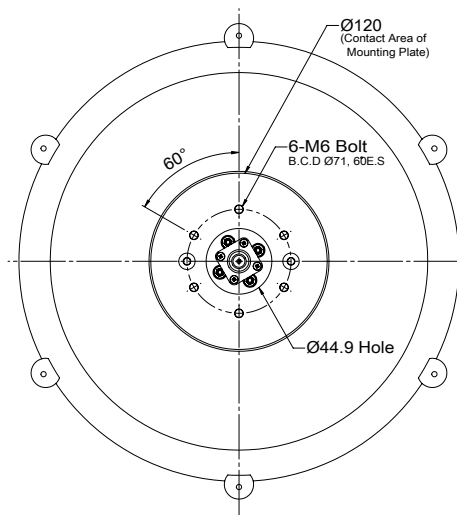

Mounting Position of FB150 Standard

Mounting Position of FB150 with Intellian i2 Matching Dome

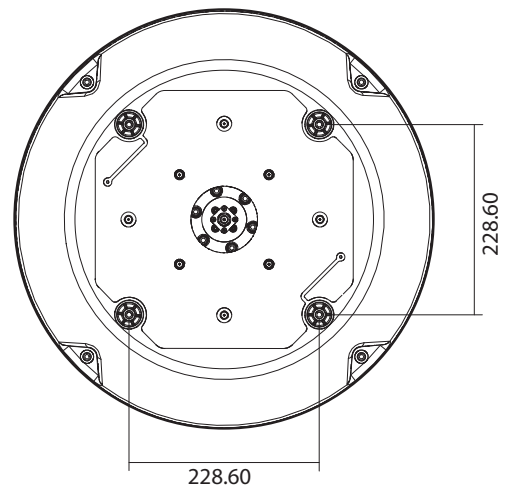
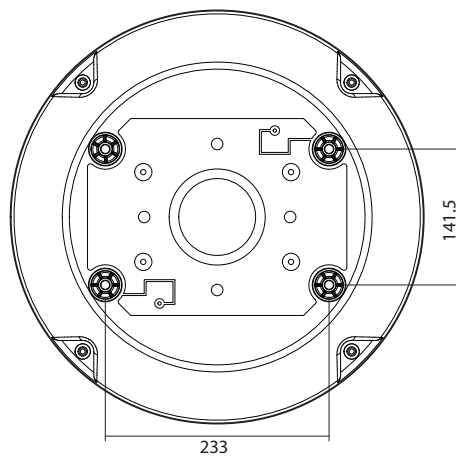

Mounting Position of FB150 with Intellian i3 Matching Dome

Mounting Position of FB150 with Intellian i4 Matching Dome

Connection of the Cable

Remove the rubber cap from RF connector. Connect the RF cable to the RF connector under the base plate through the access hole. Be careful not to over tighten, as you may damage the connector.

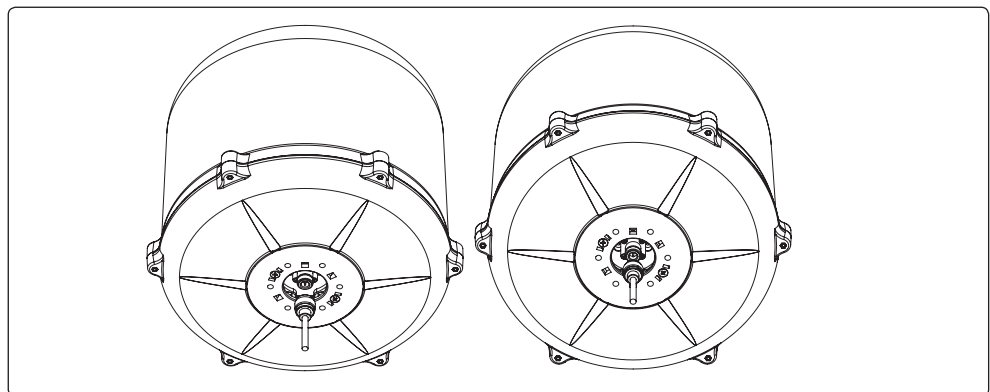

FB150 Standard Cable Connection

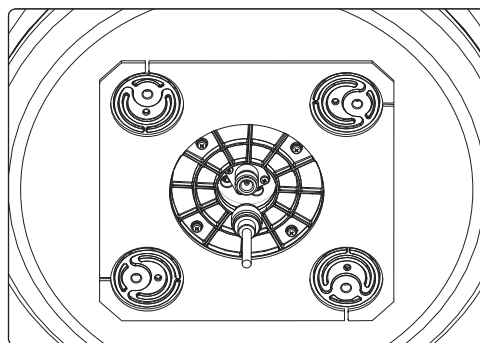

FB150 Cable Connection for Intellian i2 Matching Dome

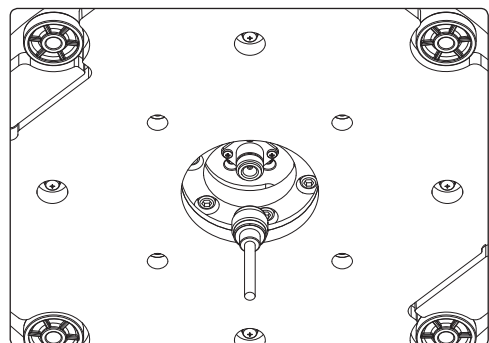

FB150 Cable Connection for Intellian i4 Matching Dome

Note: Do not tighten excessively when using the wrench, this will damage the threads. Be careful that the connectors do not touch the mounting surface of the antenna, this might cause a critical malfunction and serious damage to the equipment.

Mounting the Antenna

Fix the antenna to the holes made before as shown in the drawing below by using the hex head bolts (M6 X 35L), M6 spring washer, M6 flat washer and M6 Nut supplied. Using a 14 Nm torque wrench to tighten head bolts is recommended. A 10mm Wrench is recommended to hold bolt threads while tightening them with a torque wrench.

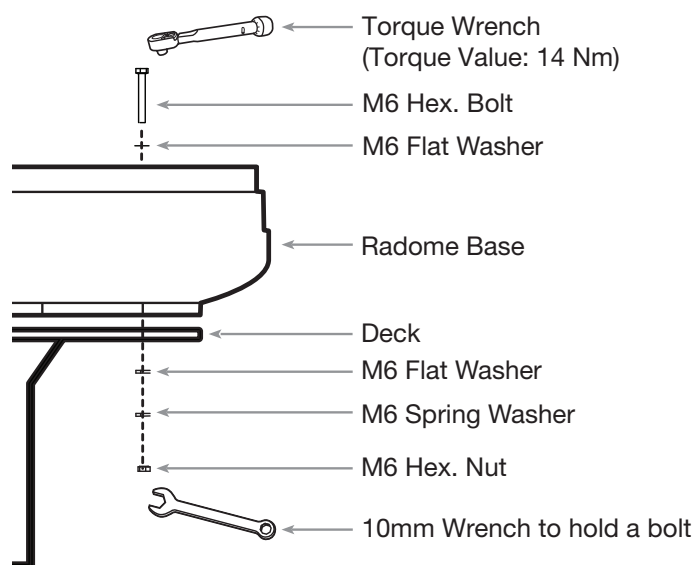

Note: For FB150 with Intelian i4 system, use the hex head bolts (M8x35L), M8 Spring washers and M8 flat washers supplied. In this case, using a 29 Nm torque wrench to tighten head bolts is recommended. A 13mm Wrench is recommended to hold bolt threads while tightening them with a torque wrench.

4.2 Installation of BDU

The BDU box is unpacked and the following items should be checked whether they are present:

- BDU
- 1 meter Wired Primary Handset with cradle
- 1.5 meters Ethernet Cable
- 1.8 meters Telephone Cord
- 1.8 meters DC Power Cable
- 1 meter GPIO (General Purpose Input / Output) cable

The following important notes are to be followed for the selection of a location before installing the BDU:

- The unit is not water proof and it has to be kept away from water splash.
- The ambient temperature and humidity in the selected location must the requirements given in the unit's specification.

Ambient Temperature	-25°C to +55°C
Relative Humidity	Up to 95% at +40°C

- The unit shall be kept away from direct sunlight.
- The unit shall be placed away from any high-vibrated and shock areas (for example, motor engine and generator) as far as possible.
- The unit shall be kept away from any equipment.
- The unit has to follow the recommended compass safe distance of 1m to prevent interference to a magnetic compass.
- For maintenance and checking, the unit's location has sufficient space at its sides and rear.

The BDU can be installed on a desktop, bulkhead, top ceiling or under captain's console.

The procedure of the installing the BDU is simple as follow:

- Place the BDU on the desired installation area.
- Look for the holes of the BDU's mounting brackets.



- Fix the holes of mounting brackets with four M4x12mm self-tapping or machined screws so that the BDU is being secured.

4.3 Installation of Primary Handset

The primary handset is provided with cradle. It can be mounted on a desktop, bulkhead, top ceiling or under captain's console as similar as the BDU.

The primary handset is to be separated from its cradle so that the cradle can be fixed with the M5 x 12mm self-tapping screws.

The procedure of the installing the cradle is simple as follow:

1. Separate the handset from the cradle and remove the plastic cover of the cradle.
2. Position the the cradle on the mounting areas.
3. Fix the cradle with M5 x 12mm self-tapping screws, which are supplied.
4. Reattach the plastic cover onto the cradle.
5. Secure the handset onto the cradle.

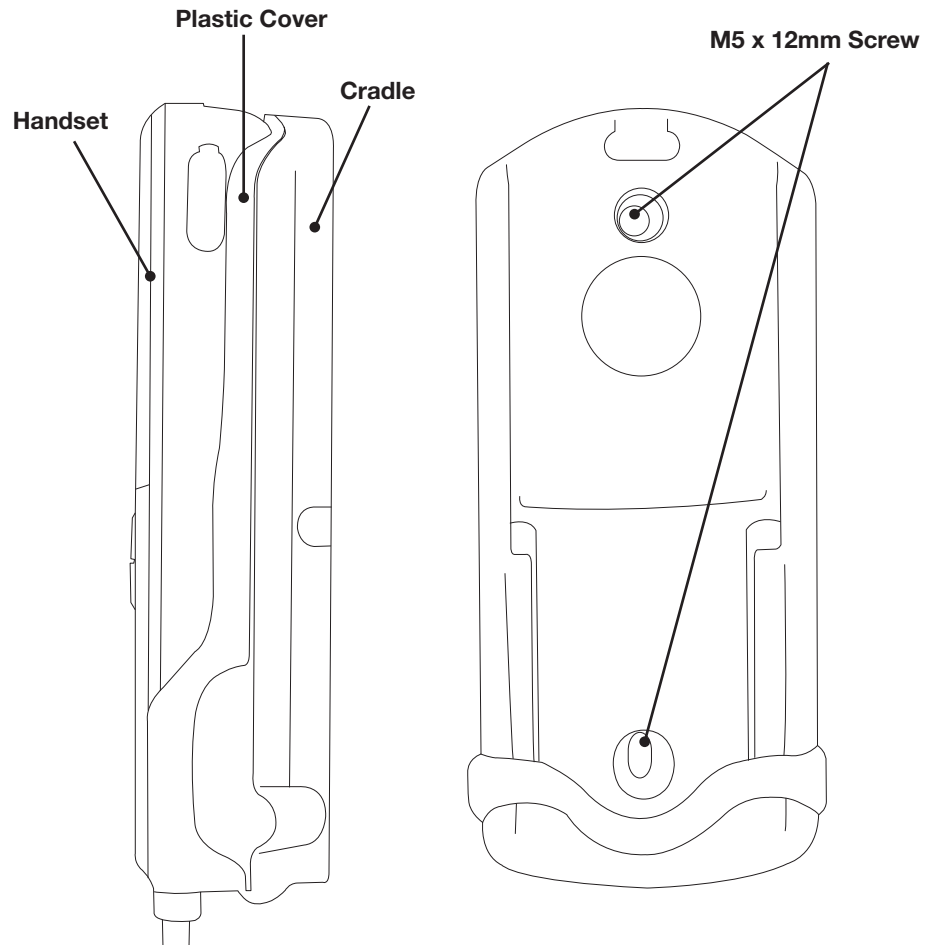

5. CONNECTIONS

Below is the interconnection diagram of FB UE with the cables.

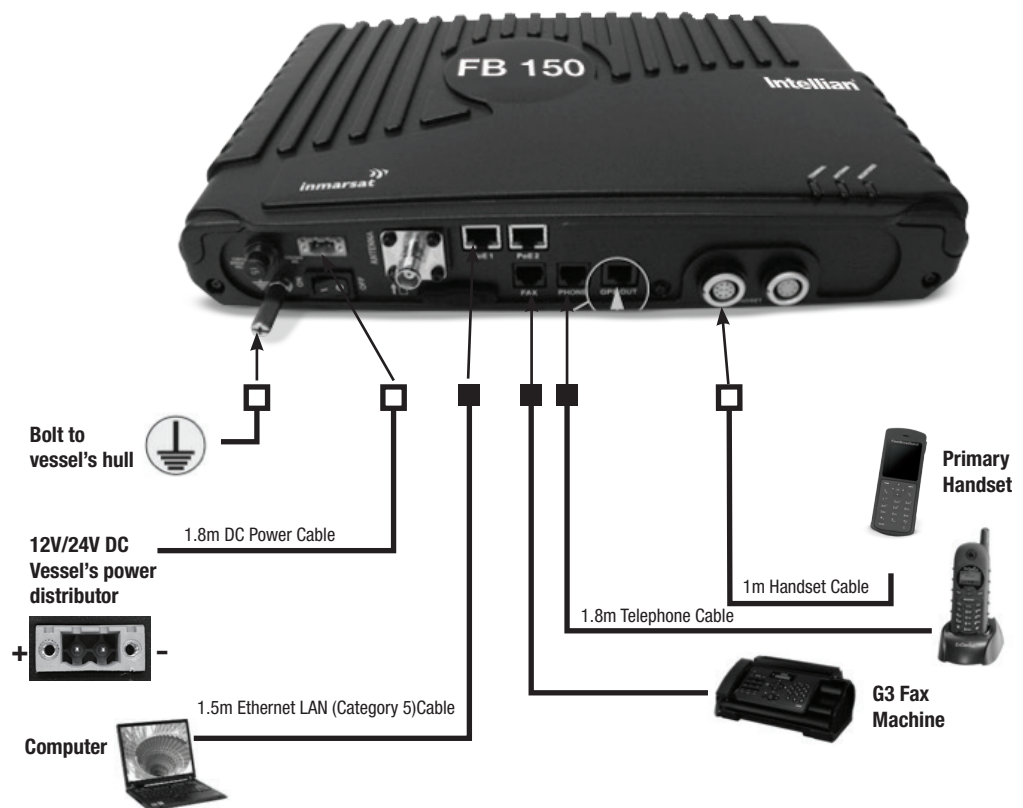

5.1 BDU's Outputs Connection

The additional information of the output ports of GPS and GPIO.

GPS Output RJ11 (Offset) Connector

The BDU has a The Transceiver Unit has a GPS output RJ11 (Offset) connector for outputting the GPS data in NMEA0183 format.

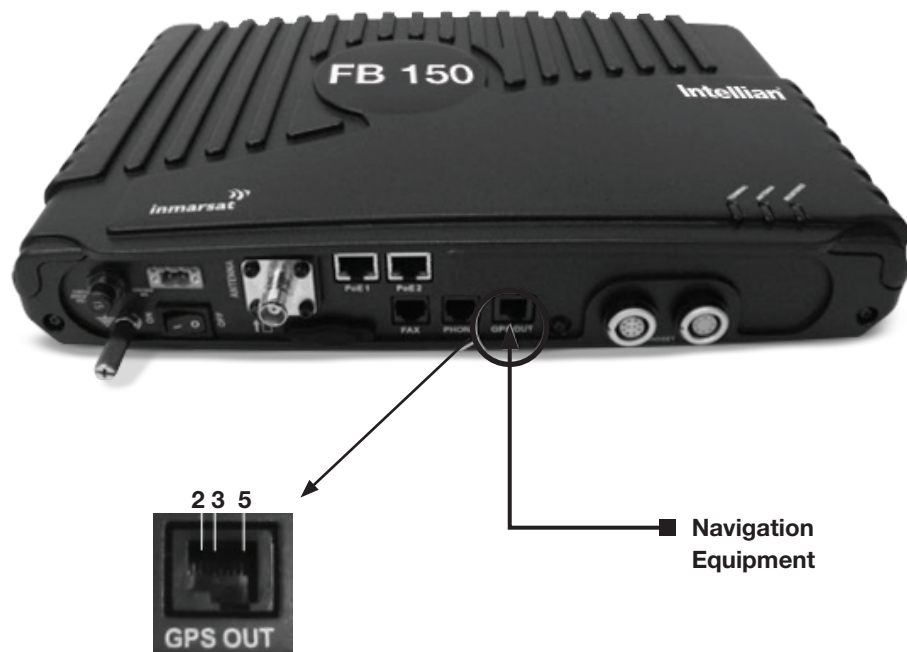

GPS Output Pinout

Pin No.	Signal
Pin 5	TX
Pin 2	RX
Pin 3	GND

RS232 Pinout

Pin No.	Signal
Pin 2	RX
Pin 3	TX
Pin 5	GND



GPIO Output

The BDU has a dedicated circular connector to provide GPIO (General Purpose Input/Output) interface to the external devices.



GPIO Output

GPIO Port Pin	Signal Name	Description of Signal	Color Code
GPIO-1	RES_1	Reserve line 1	Black
GPIO-2	GND	Ground line	Brown
GPIO-3	LED_ENABLE	To enable LED ON	Red
GPIO-4	REM_ON_OFF	Remote ON / OFF	Orange
GPIO-5	BUZZER	Buzzer	Yellow
GPIO-6	GND	Ground line	Green
GPIO-7	TX_OFF	To turn off Transmitter off	Blue
GPIO-8	+5V_DC	+5V DC Output with up to 100mA	Purple

All wires for the GPIO connector shall use AWG 24 unscreened wire type.

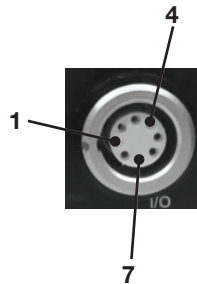

Grounding Stud

The BDU has a grounding stud with a locking screw for the earth cable (with its colors of green and yellow) with its UE lug. It is recommended to include spring washers to secure the UE lug to the grounding stud.

6. GETTING STARTED

6.1 System Configuration

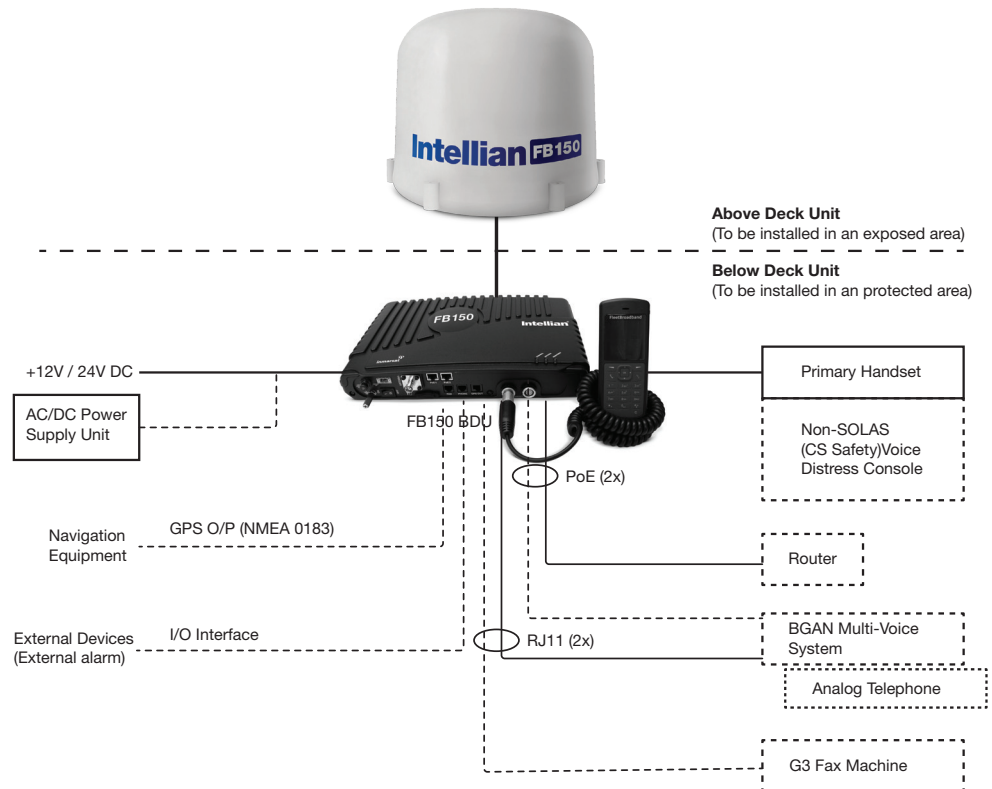

Solid line refers to the basic configuration.

6.2 Preparation for Operation

Install the SIM card.

The system requires a SIM card to access the Inmarsat's FleetBroadband network and configure the settings of the BDU. Please refer to your Airtime Service Provider for more information.

1. Tilt up the SIM card slot rubber cover.

Note: Make sure the BDU is switched off before inserting or removing the SIM card.

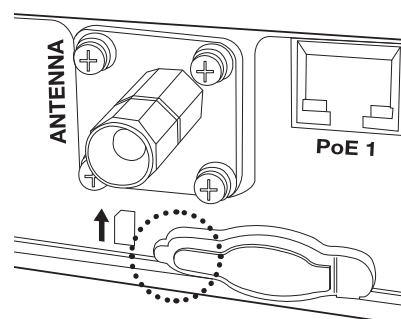

2. Position the SIM card with its gold-contacts facing down. (There is a symbol of SIM Card with its arrow on the front panel to ensure the correct orientation of the SIM Card when it is being inserted.)

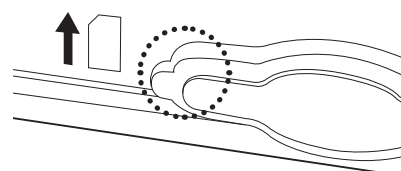

3. Push the SIM card gently until it clicks and is locked in place.

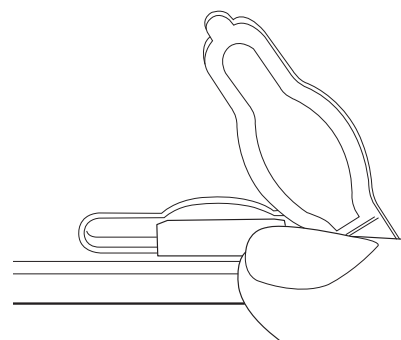

4. Tilt down the SIM card cover to its original position.

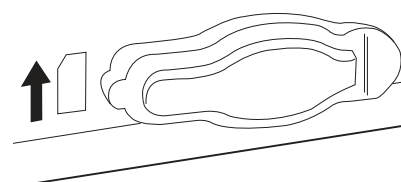

Connecting Primary Handset

The Primary Handset is powered from the BDU through the Primary Handset Port.

1. Plug in the Primary Handset connector into the Handset port on the BDU front panel. Make sure the key of the handset is aligned to the red mark of the handset port.

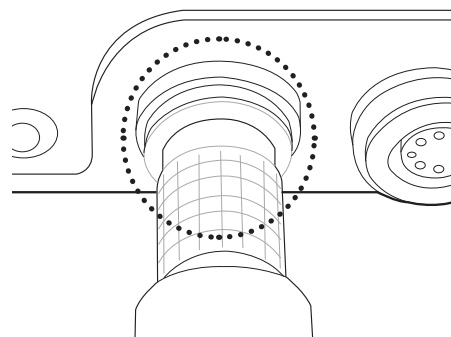

Powering Up the System

1. Use the ON/OFF switch on the BDU's front panel.

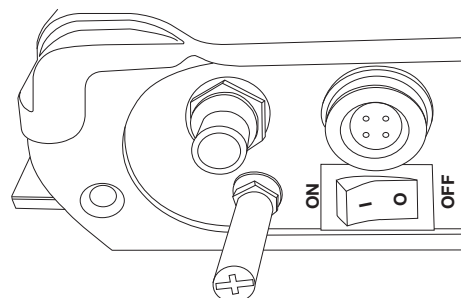

2. Wait for all LED indicators to turn green to indicate the system is completely powered up. Refer the table below for meaning of the status indicators.

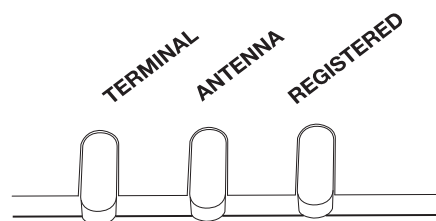

LED Name	Status	Meaning
TERMINAL	Steady Amber	BDU is powering up.
	Steady Green	BDU has powered up successfully.
	Steady Red	BDU detects failure.
	Blinking Amber	Switching OFF BDU.
ANTENNA	Steady Amber	ADU is powering up.
	Steady Red	ADU is not OK/Error
	Blinking Amber	ADU is calibrating
	Blinking Green	System performs satellite search
	Steady Green	ADU has locked on to the satellite.
REGISTERED	Steady Amber	Attempting network registration
	Steady Red	Network failure/Error
	Blinking Amber	Ready for voice only
	Blinking Green	Ready for packet data only.
	Steady Green	Ready for all. (Voice and Data)

Entering your SIM PIN

When you acquire the SIM card from the Airtime Service Provider, a PIN (Personal Identification Number: 4 to 8 digits) is provided together with it.

Note: You will need to enter the PIN at start-up if the FBB BDU has been powered down.

Follow these steps to enter the SIM PIN:

Using the keypad on the Primary Handset, enter the SIM PIN. Press **Enter** to confirm the SIM PIN.

Note: You are required to use the PUK code to unlock the SIM card and to reset your PIN code if more than three (3) incorrect attempts were used to enter the PIN code.

7. USING THE PRIMARY HANDSET

7.1 The Primary Handset

The Primary Handset is connected to the FBB UE using the dedicated HANDSET port and is powered directly from the BDU. Equipped with a large 2", 65K CSTN, 220 Liquid Crystal Display (LCD), Primary Handset not only acts as a standard phone that allows you to make/ receive voice calls, it also serves as a remote access UE (User Equipment) for you to access various configurations supported by the BDU.

Primary Handset offers the following features:

- Making standard CS voice calls
- Making standard/streaming PS background data connections
- Messaging (SMS)
- User contacts (combined SIM and BDU storage)
- Speed dial
- Call logs
- Managing BDU security settings
- Accessing BDU settings that includes:
 - o Ethernet
 - o Ciphering control
 - o Satellite selection
 - o Supplementary services
 - o Transceiver restart
 - o Limited factory reset
- Displaying various BDU status and information
- Local handset configurations



7.2 Powering Up the Primary Handset

The Primary Handset is automatically powered up once it is connected to the dedicated HANDSET port.

Depending on the conditions of the BDU, the Primary Handset may start in the following modes:

Full functioning mode

In full functioning mode, there is no PIN authentication required to start using the FBB system. All BDU settings including contacts, messages and call logs are loaded into local memory of the Primary Handset once the BDU is configured. You will be able to access all the menus and making voice or data calls once the Primary Handset is ready.

PIN mode

User is required to enter the correct PIN/password before proceeding to Full functioning mode, Refer to Security settings menu for more information on the types of security PIN in the BDU.

To enter the PIN:

1. Key in the PIN of the security key using the alpha-numeric keypad.
2. Press **Enter** key to confirm.

To cancel PIN entering:

1. Press the Right **Navigation** selection key.
2. Confirm to start in Emergency only mode by pressing the **Enter** key.

Emergency only mode

PIN authentication is bypassed (i.e. when you have forgotten the required PIN). You can only make emergency calls or access local Phone manager menu in this mode.



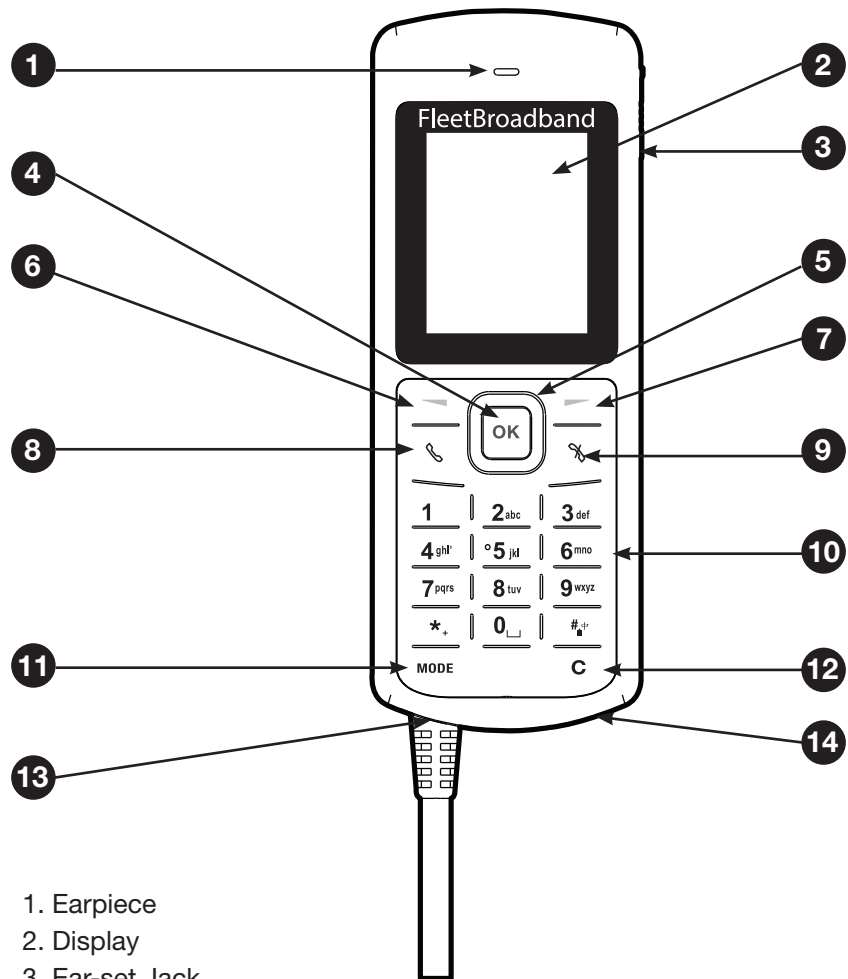





7.3 Primary Handset



1. Earpiece
2. Display
3. Ear-set Jack
4. OK Key
5. 4-Way Navigation Keys
6. Select Left Key
7. Select Right Key
8. Call/Send key
9. End key
10. Keypad (Alpha-numeric)
11. Mode Key
12. Clear Key
13. Microphone
14. Service Port
15. Ringer*

*The ringer is located at the back of the Primary Handset.

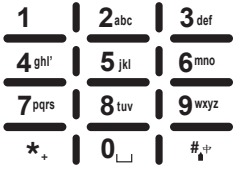
Keypad - Description and Functions

Keys	Description / Functions
	<p>4-way navigation ring* Press the 4-way navigation ring to scroll left, right, up, and down on the display. Enables scrolling through names, phone numbers, menus or settings.</p>
	<p>OK key* Pressing this key selects/confirms the function highlighted on the display.</p>
	<p>Left selection key* The function of this key depends on the guiding text shown on the display above the key.</p>
	<p>Right selection key* The function of this key depends on the guiding text shown on the display above the key.</p>
	<p>Call/Answer key* After entering a phone number: Initiates a call to the number. From Main Display screen: Opens a list of dialed calls When Ringing: Answers the incoming call.</p>
	<p>Call/Menu End key* Press this key to end active calls or exits from any menus or sub menus.</p>
	<p>Keypad* Used to enter numbers and characters. Press 0 to add a space when writing text. The functions available depend on whether you are typing a phone number (number mode) or text (text mode).</p>
	<p>Star key* When entering a phone number, press this key to insert a *. Press and hold this key to insert a +. When writing text, press this key to access a list of special symbols.</p>
	<p>Hash key* When entering a phone number, press this key to insert a #. To quickly change the text input method when writing text, press this key repeatedly and check the indicator at the top of the display. In standby mode, press and hold this key to set the Primary Handset into silent mode.</p>
<p>MODE</p>	<p>Mode key* Unplug the handset from BDU, press and hold this key when handset unplugged and plug in the Handset. Handset power up in Firmware Upgrade Mode.</p>
<p>C</p>	<p>Clear Key* Press key once to clear one character at a time or press and hold this key to clear the whole text entry.</p>

The Main Display Screen



1. BDU Status Indicator line

The indicator line shows status symbol informing you about the operating conditions of the BDU.

2. Satellite

The indicator line shows status symbol informing you about the satellite service.

3. Handset Status Indicator line















The indicator line shows status symbols informing you about the operating conditions of the Primary Handset.

4. Selection Key line

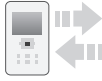
The Selection key line operates using the **Left or Right selection keys*** with the **OK Key*** to access menus and controls.

Primary Handset Status Indicators



Table below explains the meaning of each status indicator displayed in the Main Display screen.

Status Indicator	Description
	New short message (SMS) in inbox.
	Available CS domain services.
	Available PS domain services.
	Data connection is inactive. (Available in Manage profiles sub menu only)
	Data connection is active.
	Ciphering is enabled.
	Radio silent is enabled.
	Primary Handset keypad lock is active.
	Primary Handset disconnected from BDU.
	Primary Handset connected to BDU.
	The terminal has locked on to Inmarsat satellite "I-4 Asia Pacific".
	The terminal has locked on to Inmarsat satellite "I-4 EMEA".
	The terminal has locked on to Inmarsat satellite "I-4 Americas".
	Primary Handset in silent mode.
	Telephony CS port is engaged.
	Signal strength.

Primary Handset Operations

Making a Voice Call

Before making a voice call, please make sure that:

- The Primary Handset is connected to the BDU.
( Status indicator should be on.)
- The Primary Handset is NOT radio silent. ( Status indicator should be off.)
- The BDU has successfully registered with the network and ready for CS domain (voice) services. ( Status indicator should be on.)

You can use the following two options for making a call:

- Manual Dial:
 1. Using the alphanumeric keypad, dial 00 <country code> <phone number>.
 2. Press **Call/Answer key***.



- Using Contacts or Call Log list from the Primary Handset:
 - Enter the Contacts list of the Primary Handset; scroll to the desired number and press **Call/Answer key***, or
 - Enter the Log list of the Primary Handset; scroll to the desired number and press **Call/Answer key***.

Note: For voice calls and SMS, you may also use '+' by pressing and holding the *+ key instead of "00" at the beginning of dialled number string as an alternative (+ <country code> <phone number>).

To End a Call

1. Press **Call/Menu End key***



Receiving a call

When there is an incoming call, the Primary Handset will,

- Ring.
- The calling party's number will be displayed on the screen.
If the number is stored in the contacts, the corresponding name of contact will be displayed.

To answer an incoming call, press the **Call/Answer key***

Adjusting volume during a call

Use the 4-way navigation ring **4-way navigation ring*** to adjust the volume.

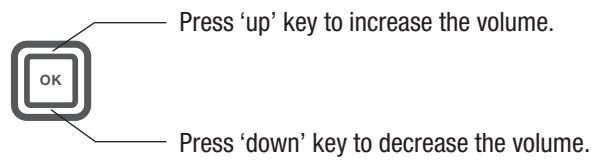









Using the Menus

You can access the Menu System by pressing the **Right selection key*** in the Main Display screen.

The main menu of the Primary Handset includes nine (9) menu options with each menu option having their respective sub-menus.

You can use the 4-way navigation **4-way navigation ring*** to navigate to the desired menu option and press **OK Key*** to confirm your selection. You can also end the menu or sub menu and return to the Main Display screen at any time by pressing the **Call/Menu End Key***.

Table below summarizes the functionalities within each menu option:

Status Indicator	Description
	Contacts This menu manages your user contacts.
	Log This menu allows you to view call histories.
	Telephony This menu configures settings related to CS voice telephony services.
	Data This menu configures settings or connections related to PS data services.
	Messaging This menu is for SMS related services.
	Settings This menu configures general BDU settings.
	Transceiver This menu displays general BDU information.
	Security settings This menu configures security settings related to the BDU.
	Phone manager This menu configures local handset settings.

Contacts Menu

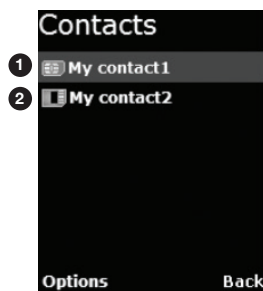

The Contacts menu allows you to store, retrieve and update names and phone numbers of your contacts in the Primary Handset memory and in the SIM card memory. You can also access this menu by pressing **Left selection key*** in Main Display screen. This menu lists all the contacts saved in both the BDU and SIM card memory where.

- ① Indicates contacts that are saved in BDU and
- ② Indicates contacts that are saved in SIM card.

The following options are available when pressing the **Left selection key*** while browsing through the contacts:

- **New contact**

Add new contact to the memory. To add contact:

1. Select **New contact**.
2. Select where you want to store the contact (BDU or SIM).
3. Enter the name for the contact.

Note: Press Star key* to browse for symbols.

4. Enter the number for the contact.

Note: Stored number can be in any one of the following formats:

- '+' <country code> <phone number>
- 00 <country code> <phone number>

Press Star key* to insert '+' sign.

Saving of contact without number is not allowed.

5. Select **Save (Left selection key*)** or pressing the **OK key*** to save the contact to the selected memory.

Note: Refer to “Tips for writing the text” section under New message for more information on text writing.

- **Search** : Select this to enter a specific name to search within the contact list.
- **Delete** : Delete selected contact.

Note: You can also delete the selected contact by pressing the **Clear key***.

- **Copy** : Select this to copy the selected contact from SIM card memory to BDU memory or vice versa.
- **View number** : Display the number of the selected contact.
- **Assign Speed Dial** : Add the selected contact to the speed dial list.
- **Reload Contacts** : Select this to reload contacts from the BDU/SIM card into the local memory of the Primary Handset.
- **Memory Status** : Select this to view the memory status of the contacts.

While browsing through the contact list, press the **OK key*** to view the phone name and number or the selected contact. The following options are available when pressing the **Left selection key*** while viewing the selected contact:

- **Call** : Make a voice call to this contact.
- **Send message** : Open a SMS editor to send a text message to this contact.
- **Edit contact** : Edit information of this contact.
- **Delete** : Delete this contact.
- **Copy** : Select this to copy this contact from SIM card memory to BDU memory or vice versa.
- **Forward contact** : Forward information of this contact using SMS.
- **Assign Speed Dial** : Add this contact to the speed dial list.

Note: You can also make a voice call to the selected contact when browsing through or viewing the contacts by pressing the **Call/Answer key***.

Log Menu

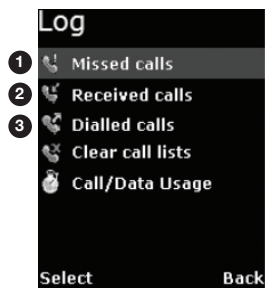

The Log menu allows you to view historical information about phone calls and data usage in chronological order with the following sub menus:

- ① Missed calls
- ② Received calls
- ③ Dialled calls

Call history of the particular category is displayed in chronological order when selected. Up to 5 latest entries of each category can be saved.

The following options are available when pressing the **Left selection key*** while browsing through or viewing the call log:

- **Delete**
Delete the selected log entry from the list.
Note: You can also delete the entry by pressing the **Clear key***.
- **Call**
Call the number in the selected log entry.
- **Send**
Send an SMS to the number in the selected log entry.
- **Save**
Save the number from the selected log entry to the contact list.

Note: This option is not available when the log entry already has an entry in the contact list.

Note: You can also make a voice call to the number of the selected log entry when browsing through or viewing the call log by pressing the **Call/Answer key***.

Clear call lists

Select this to clear the call log entries. Available log options are:

Missed calls

- **Received calls**
- **Dialled calls**
- **All calls**

Delete all logs including **Missed**, **Received** and **Dialled** logs.

Call/Data usage

Display the accumulated call and data duration. Press **Left selection key*** to clear the call or data duration.

Telephony Menu

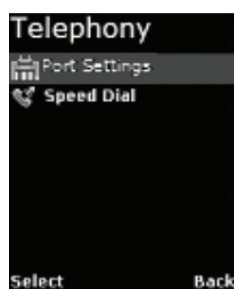

The Telephony menu allows you to configure telephony related settings with the following sub menus:

Port Settings

- Primary Handset
Contain options for incoming and outgoing call types.
Select this to configure the call type settings. The following options are available when pressing the **Left selection key*** while browsing through the list:
 - Standard
 - NONE
- Phone Port
Contain options for incoming and outgoing call types.
Select this to configure the call type settings. The following options are available when pressing the **Left selection key*** while browsing through the list:
 - Standard
 - High quality [Note: only applicable if fax is purchased]
 - BOTH (only for incoming) [Note: only applicable if purchase fax]
 - NONE
- Fax (OPT) Port
Contain options for incoming and outgoing call types.
Select this to configure the Fax type settings.
The following options are available when pressing the **Left selection key*** while browsing through the list:
 - High quality [Note: only applicable if purchase fax]
 - NONE

Speed dial

- **Setting**
Contain options to enable/disable the speed dial feature
- **Speed Dial List**
Select this to configure the speed dial list. The following options are available when pressing the **Left selection key*** while browsing through the list:
- **Assign**
Assign a contact to the selected entry. To assign a contact:
 1. Select Speed Dial List.
 2. Browse through the list to locate an empty entry.
 3. Select Options by pressing **Left selection key***.
 4. Select Assign and press **OK key*** from the option.
 5. Select the desired contact to assign to the speed dial list.
 6. Press **OK key*** to confirm your selection.
- **Delete**
Remove contact from the selected entry. This option is not available for empty entry.

Note: You can also delete the entry by pressing the **Clear key***.
- **Call**
Make call using the number from the selected entry.
This option is not available for empty entry.

Note: You can also make a voice call to the number of the selected entry by pressing the **Call/Answer key***.

You can make a voice call directly from the Main Display screen by pressing the corresponding speed dial entry number + **Call/Answer key*** once the speed dial feature is enabled with a valid contact entry.

Data Menu

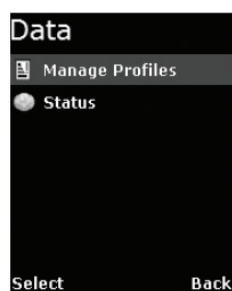

The Data menu provides the following sub menus to manage and configure data connections (PDP profiles) for the BDU:

Manage profiles

Allow you to manage the Primary and Secondary PDP profiles.

- Primary profiles
One Standard Primary PDP profile has been created in the Primary profile list as a default profile. The profiles listed in the list are:
 - Standard
 - 32k Streaming
 - 64k Streaming
 - 128k Streaming

You can press the **Left selection key*** for options available when browsing through the profile list. The list of options is:

- o **Edit**
Edit the selected profile.
- o **Delete**
Delete the selected profile.
- o **Add**
Add new profile into the list.
- o **Reset table**
Reset profile list. All profiles will be deleted and a default profile is created.

Adding / Editing profiles

You can press the **Left selection key*** or **OK key*** from the option list to add new or edit existing profile settings.

- **Profile name**

Specify the name of the profile.

- **Connection type**

Both **Standard** and **Streaming** connection types are supported.

- **APN**

Specify information of the APN (Access Point Name). Further available settings are:

APN: Specify the Access Point Name for the connection. Default APN is according to SIM card. Enter your own APN if you do not want to use the default APN from the SIM card.

Username: Specify the user name for **Static** IP configuration. Default is blank for **Dynamic** IP configuration.

Password: Specify the password for **Static** IP configuration. Default is blank for **Dynamic** IP configuration.

You can press the **Left selection key*** for the following options:

- **Edit**

Edit the selected APN setting

- **Fetch from SIM**

Fetch the APN from the SIM card. This option is only available when APN is highlighted.

- **IP configuration**

Contain options for **Static** or **Dynamic** IP. Default is **Dynamic** IP configuration.

- **IP address**

Specify the IP address for **Static** IP configuration.

This field is ignored for **Dynamic** IP configuration. Default is blank for **Dynamic** IP configuration.

- **Header comp.**

Contain options to enable or disable header compression. Default is **Enabled**.

Note: For 32k, 64k and 128k Streaming profiles, there are three additional options when selecting editing their settings. The additional options are:



- **Desired rate**
Choose the desired rate for the different profiles. Note that the default setting for each profile is the profile chosen. For example, for 32k Streaming, the default rate is 32k.
- **Minimum rate**
Choose the minimum rate for the different profiles. Note that the default setting for each profile is the profile chosen. For example, for 32k Streaming, the default rate is 32k.
- **Error correction**
Contain options to enable or disable error correction.
Default is disabled.
- **Secondary Profiles**
The profiles listed in the list are:
 - FTP
 - Quick Link
 - Quick Time Media
 - Real Media
 - Stream Box
 - Win Media

Adding/Editing profiles

You can press the **Left selection key*** or **OK key*** from the option list to add new or edit existing profile settings.

- **Profile name**
Specify the name of the profile.
- **TFT**
Choose desire type of connection.
- **Desired rate**
Choose the desired rate for the profile. Default settings for all secondary profiles are set as 32K.
- **Minimum rate**
Choose the minimum rate for the profile. Default settings for all secondary profiles are set as 32K.
- **Error correction**
Contain options to enable or disable error correction.
Default is Disabled.

Note: You will be prompted to save the changed settings before exiting the sub menu. Press **Left selection key*** or **OK key*** to save the changes.

Icon  in the profile list indicates that the profile is not active and icon  indicates that the profile is currently active in use.

Status

Allow you to check the status of the data connection. You can also activate / de-active a specific profile in the status display list.

Note: You will not be able to enter this sub menu if the BDU has not been registered for PS data service.

The status list shows you the current active data connection. Depending on whether there is an active connection, you can press the **Left selection key*** for the following options:

- **Activate Primary**
This option is available when there is no active data connection. Select this to choose from the profile list for activation.
- **Deactivate**
This option allows you to deactivate an active data connection.

To active a primary data connection when there is no active connection:

1. From the data status list, select Options using the **Left selection key***.
2. Select Activate primary using **Left selection key*** or **OK key***.
3. Select from a list of configured primary profile for activation.
Press **Left selection key** or **OK key*** to confirm.
4. You are prompted to confirm activation. Confirm activation by selecting yes using the **Left selection key** or **OK key***.

Note: It may take a while to active a data connection.

To de-activate a primary data connection when there is an active connection:

1. From the data status list, select Options using the **Left selection key***.
2. Select Deactivate using **Left selection key*** or **OK key***.
3. You are prompted to confirm de-activation. Confirm de-activation by selecting Yes using the **Left selection key*** or **OK key***.

Messaging Menu



The **Messaging** menu allows the user to write a new message, view stored messages from **Inbox**, **Drafts** and/or **Sent** folders and configure settings related to SMS with the following sub menus:

1 New Message

Select this to create and send a new message. To create new message:

1. Select **New Message** by pressing the **OK key***.
A SMS editor will be displayed on the Primary Handset screen for writing new message.
2. Type in your SMS message using the alphanumeric keypad.
3. To send the message, press the **OK key*** and select Send.
4. Enter the recipient's phone number, and press the **OK key***.
Alternatively you can select **Search** by pressing the **Left selection key*** to select the phone number from the contacts.

Options:

You can press the **Left selection key*** to select options available when writing the message.

- **Send**
Select this when you are ready to send your message.
- **Save**
Select this to save the message into the **draft** folder.
- **Clear screen**
Select this to clear all the written text.

Tips for writing the text:

- Press the **0** key to add a space.
- To quickly change the text input mode when writing text, press **Hash key*** repeatedly and check the indicator at the top of the display:
 - o <ABC>: Capital letters
 - o <123>: Numbers
 - o <abc>: Small letters
 - o <Abc>: Initial Capital letter followed by small letters
- To add a number in alphabet mode, press and hold the desired number key.

Inserting symbols to your message:

- To get a list of special symbols, press the **Star key***.
- Using the **4-way navigation ring***, navigate to the desired symbol.
- Press **Ok key*** to confirm selection.

Clearing text:

- To clear text, press **Clear key*** once to clear one character at a time.
- To clear the whole text entry, press and hold **Clear key*** to clear the whole text entry.

2 Inbox

Contain new/opened text messages that you have received. When browsing through the messages list using the **4-way navigation ring***,



Indicates an unread (new) message and



Indicates read (opened) text messages.

The following are available options when pressing the **Left selection key*** while browsing through or viewing the messages in this folder:

The following are available options when pressing the **Left selection key*** while browsing through or viewing the messages in this folder:

- **Open**
Open selected message. You can also press **OK key*** while browsing through or viewing the messages in this folder:
- **Reply**
Select this to reply to the selected message sender.
- **Delete**
Delete selected message.

Note: You can also delete the selected message by pressing the **Clear key***.

- **Forward**
Forward this message to another recipient.
- **Call**
Make a voice call to the selected message sender.
- **Save**
Save the selected message into the Draft folder.
- **Details**
Display the details of the selected message.
- **Add to contact**
Select this to add the phone number of the selected message into the contact list.

Note: You can also make a voice call to the selected message contact when browsing through the messages list by pressing the **Call/Answer key***.

Sent

Contain text messages that you have sent. The following are available options when pressing the **Left selection key*** while browsing through or viewing the messages in this folder:

- **Open**
Open selected message. You can also press **OK key*** while browsing through the message list to open the selected message (This option is not available when viewing the message).
- **Delete**
Delete selected message.

Note: You can also delete the selected message by pressing the **Clear key***.

- **Send**
Send the selected message to another recipient.
- **Save**
Save the selected message into the Draft folder.
- **Add to contact**
Select this to add the phone number of the selected message into the contact list.

Note: You can also make a voice call to the selected message contact when browsing through the message list by pressing the **Call/Answer key***.

Draft

Contain text messages that you have saved. The following are available options when pressing the **Left selection key*** while browsing through or viewing the messages in this folder:

- **Open**
Open selected message. You can also press **OK key*** while browsing through the message list to open the selected message (This option is not available when viewing the message).
- **Delete**
Delete selected message.

Note: You can also delete the selected message by pressing the **Clear key***.

-
- **Send**
Send this message to another recipient.
 - **Save**
Save the selected message into the Draft folder.
 - **Add to contact**
Select this to add the phone number of the selected message into the contact list.

Note: You can also make a voice call to the selected message contact when browsing through the message list by pressing the **Call/Answer key***.

OPTIONS

The following settings are available in this sub menu:

- **Message Centre**
Select this to set the number of the SMS service centre.
- **Save sent message**
Select this to enable or disable the saving of sent messages.
When this option is enabled, all successfully sent messages are saved in the Sent folder.
- **Memory status**
Select this to view the memory status of the messages.
- **Reload Messages**
Select this to reload messages from the BDU into the local memory of the Primary Handset.

DELETE ALL

Select this to clear the messages in a particular folder. Available folder options are:

- **All messages**
Delete messages in all folders including Inbox, Sent and Draft.
- **Inbox**
- **Sent**
- **Draft**

Settings Menu

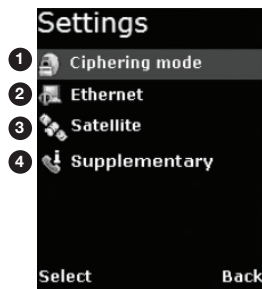

The Settings menu provides the following sub menus to configure the BDU:

Ciphering mode

Contain options to enable/disable the use of ciphering mode between the network and BDU.

Note: Status icon  is displayed in the Main Display screen when ciphering is enabled.

Ethernet

Allow you to configure settings related to Ethernet connection.

- **Transceiver IP Address**
Specify the IP address of the BDU.
The default IP address of the BDU is 192.168.1.35
- **Subnet Mask**
Specify the subnet mask of the BDU.
The default subnet mask of the BDU is 255.255.255.0
- **DHCP settings**
Display the status and settings of the DHCP server.
 - **DHCP server:** Display the status of the DHCP server.
 - **Start IP address:** Display the start IP address of the DHCP server.
Default start IP address is 192.168.1.40.
 - **End IP address:** Display the end IP address of the DHCP server.
Default end IP address is 192.168.1.59.
 - **Primary DNS:** Display primary DNS server address.
Default primary server is 172.30.66.7.
 - **Secondary DNS:** Display secondary DNS server address.
Default secondary server is 172.30.34.7.

- Lease time

Display the lease time. Default lease time is 60.

Except for DHCP server, the rest of the display settings can be edited by pressing the **Left selection key*** or **Ok key*s**.

Note: Make sure that the format is correct when entering an IP address. Press the **Star key*** multiple times to insert the “.” sign.

Satellite

Manage settings related to Inmarsat satellites.

- **Satellite selection**
Allow you to select the preferred satellite to lock on to.
Default is AUTO where the BDU automatically searches for the best satellite in view to lock on to.

Note:

Satellites visible to the BDU are marked with *. The BDU will de-register from the network with all the CS (voice) and PS (data) services terminated whenever a new satellite is manually selected from the list. The BDU can only re-register with the network once it has successfully locked onto the newly selected satellite.

Satellite status

Display current satellite status. The following information is displayed:

- Status

Display status of the BDU. The BDU can be either searching or locked on to a particular satellite.

- Satellite ID

Satellite ID that the BDU is currently searching for or locked on.

- Satellite Name

Satellite Name that the BDU is currently searching for or locked on.

Supplementary

Configure settings related to supplementary services. These settings are applicable to standard CS voice services.

Note: Depending on the network, some settings may not be available or may prevent other settings from being activated.

The following information is available:

- **Call forwarding**
Allow you to configure for call forwarding services depending on various conditions. The following forwarding conditions are available for configurations:
 - **All Calls**
All calls are unconditionally forwarded.
 - **Busy**
Calls are forwarded when the BDU is busy.
 - **No answer**
Calls are forwarded when no answer from the BDU for a specific time.
 - **Not reachable**
Calls are forwarded when BDU is not reachable.

You can press the **Left selection key*** for options available when browsing through the list of forwarding conditions. The list of options is:

- **Retrieve all**
Retrieve network settings of all the listed conditions.
- **Update all**
Update configured settings of all the listed conditions to the network.
- **Cancel all**
Deactivate all condition settings.

Note: Operations on this level affect all forwarding conditions and hence it may take some time to process.

Pressing the **OK key*** configures a particular forwarding condition. The following settings can be configured:

Status: Display active or inactive status of the selected forwarding condition. Press the **OK key*** to change the status.

Number: Display number to forward calls to when selected forwarding condition is active. Press the **OK key*** to change the number.

Time: Only applicable to No answer forwarding condition. To forward calls to selected number if call no answer for a specific period of time. Press the **OK key*** to change the time.

You can press the **Left selection key*** for options available when configuring a particular forwarding condition. The list of options is:

- **Retrieve**
Retrieve network settings of the selected condition.
- **Update**
Update configured settings to the network for the selected condition.

Note: Always use Retrieve all or Retrieve options to retrieve the latest settings from the network. Use Update all or Update options to update the network settings after configurations.

- **Call barring**
Allow you to configure for call barring services depending on various barring conditions. The following conditions are available for activations/deactivations by pressing the key:
 - **Outgoing calls**
Barring of all outgoing calls.
 - **Incoming calls**
Barring of all incoming calls.
 - **Int. except home**
Barring of all outgoing international calls except to home country.
 - **Incoming if abroad**
Barring of all incoming when roaming.

You can press the **Left selection key*** for options available when browsing through the list of barring conditions. The list of options is:

- **Retrieve**
Retrieve network settings of the highlighted condition.
- **Retrieve all**
Retrieve network settings of all the listed conditions.
- **Update**
Update configured settings to the network for the highlighted condition.
- **Update all**
Update configured settings of all the listed conditions to the network.
- **Cancel all**
Deactivate all condition settings.

You will be asked to enter the call barring password when updating the settings to the network. Consult your equipment distributor if necessary.

Note: Always use Retrieve all or Retrieve options to retrieve the latest settings from the network. Use Update all or Update options to update the network settings after configurations.

-
- **Call Waiting**
Contain options to enable/disable call waiting services.
You can also press the Left selection key for the following options:
 - **Retrieve**
Retrieve network settings of the call waiting service.
 - **Update**
Update configured settings to the network.

Note: Always use Retrieve option to retrieve the latest settings from the network. Use Update option to update the network settings after configurations.

- **Caller ID**
Allow you to configure settings that are related to caller identifications.
 - **Setting**
Contain options to configure for USA or Europe caller ID type.
- **Send Caller ID**
Allow you to enable/disable sending of your caller ID to the recipient when making a call. Default is AUTO where the default network settings are used. You can also press the **Left selection key*** for the following options:
 - **Retrieve**
Retrieve network settings of the waiting service.
 - **Update**
Update configured settings to the network.

Note: Always use Retrieve option to retrieve the latest settings from the network. Use Update option to update the network settings after configurations.

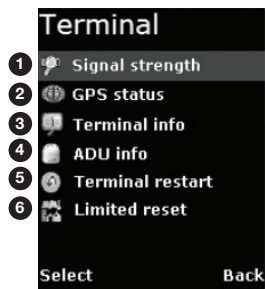

Terminal Menu



The **Transceiver** menu provides the following sub menus to check for information and perform resets on the BDU:

Signal strength

Show graphical representation of current signal strength and GPS type. Table below describes the available GPS type icons used in this sub menu:

	This icon shows that the BDU is in the process of acquiring a GPS fix when there is no previously stored GPS fix.
	This icon shows that the BDU is using New GPS coordinates.
	This icon shows that the BDU is using previously stored GPS coordinates.

GPS status

Show current Latitude and Longitude coordinates, the GPS type and Time of acquisition on the BDU.

Transceiver Info

Display a list of information of the BDU.

- Manufacturer: Manufacturer name of the BDU
- Software version: Software version of the BDU
- Model: Model name of the BDU
- IMEI number: IMEI number of the BDU
- IMSI number: IMSI number of the SIM card
- Subscriber number: Subscriber's telephone number
- Serial number: Serial number of the BDU

Antenna Unit Info

Display a list of information of the Antenna.

- **Serial number**

Serial number of the Antenna

Transceiver restart

Soft restarting the BDU

Limited reset

Perform limited reset on the BDU. Apart from full factory reset that is not available in Primary Handset, limited reset only resets a small portion of the BDU settings. Stored GPS status, contacts, call logs and event logs are not cleared during limited reset.

You are also required to key in the password when performing the reset. The default password is 0000.

Note: This password is the same as Terminal PIN.

Security settings Menu

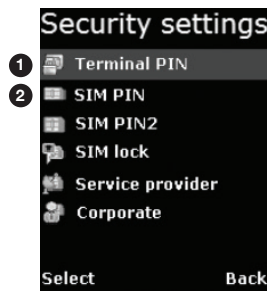

The Security Settings menu provides the following sub menus to configure the security settings of the BDU using different PIN:

- ① Terminal PIN
- ② SIM PIN

There are three options available for selection under each sub menus to manage the PIN and security settings for the BDU:

- **Enable**
Enable the selected PIN. Table below summarizes the default PIN codes for each security setting:

Terminal PIN	0000 Note: Terminal PIN is the same PIN that has to be entered when performing Limited Reset on the BDU.
SIM PIN	Depends on your SIM card. Consult your equipment distributor if necessary. Note: You have to enter the PUK (PIN Unblocking Key) to access the SIM card if a wrong PIN for SIM PIN has been entered for three times. You will be asked to enter the new PIN code once you have entered the correct PUK. However, the SIM card is no longer usable if you have entered wrong PUK for 10 times.

You will be asked to key in the existing PIN (or default PIN if it has not been changed) before the PIN can be enabled.

- **Disable**
Disable the selected PIN. You will be asked to key in the existing PIN (or default PIN if it has not been changed) before the PIN can be disabled.
- **Change**
Change the PIN to a new one. You will be asked to key in the existing PIN (or default PIN if it has not been changed) before the PIN can be changed.

Note: PIN has to be enabled before it can be changed.

Phone manager Menu



The Phone manager menu provides the following sub menus to configure settings that are local to the Primary Handset:

Display

Configure settings that are related to Primary Handset display.

- **Backlight**

To set the duration of the display backlight to remain on.

Settings range from Always On (Backlight permanently turned on), 15 seconds to 1 minute.

Note: The backlight will be slightly dimmer and finally off when there is no keypad activity after sometime. However, this feature is not available when the setting is set to Always On.

Tone

Configure tone setting for the standard and ring tones.

- **Standard tone**

- **Key tone**

Contain options to enable/disable the key tone.

- **Message tone**

Contain options to enable/disable the message tone.

- **Volume**

Configure the volume for the standard tones (both key and message tones).

Using the **4-way navigation ring***, press up/right to increase and down/left to decrease the volume.

- **Ring tone**

- **Tone**

- Select desired ring tone pattern.

- **Volume**

- Configure the volume of the ring tone. Using the **4-way navigation ring***, press up/right to increase and down/left to decrease the volume.

Language

Allow you to change the menu display language.

Factory settings

Allow you to configure default factory settings of the Primary Handset.

Contains the following settings:

- **Factory reset**

- Perform factory reset on the Primary Handset

About

Display a list of information of the Primary Handset.

- **Model**

- Model name of the Primary Handset

- **Software version**

- Software version of the Primary Handset

- **Hardware version**

- Hardware version of the Primary Handset

- **Technical support**

- Web address for technical support

- **Copyright**

- Contain Copyright message

8. USING THE WEB CONSOLE

8.1 Register to the Network

1. Connect your computer to the FBB BDU using a LAN cable.
2. When the connection has been established, open the web browser.
3. Type `http://192.168.1.35` in the Address field and press Enter.

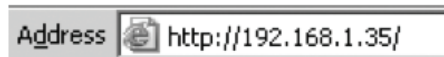

4. When the Login screen appear, type in `admin` in the Username field and `1234` in the password field. Click Login.

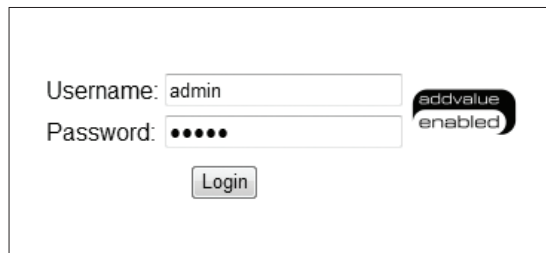
A screenshot of a login interface. It features two input fields: "Username:" containing the text "admin" and "Password:" containing five dots. To the right of the password field is a logo that says "addvalue enabled". Below the fields is a "Login" button.

5. Click the Login button.

The FBB BDU **Web Console** will appear on your screen.

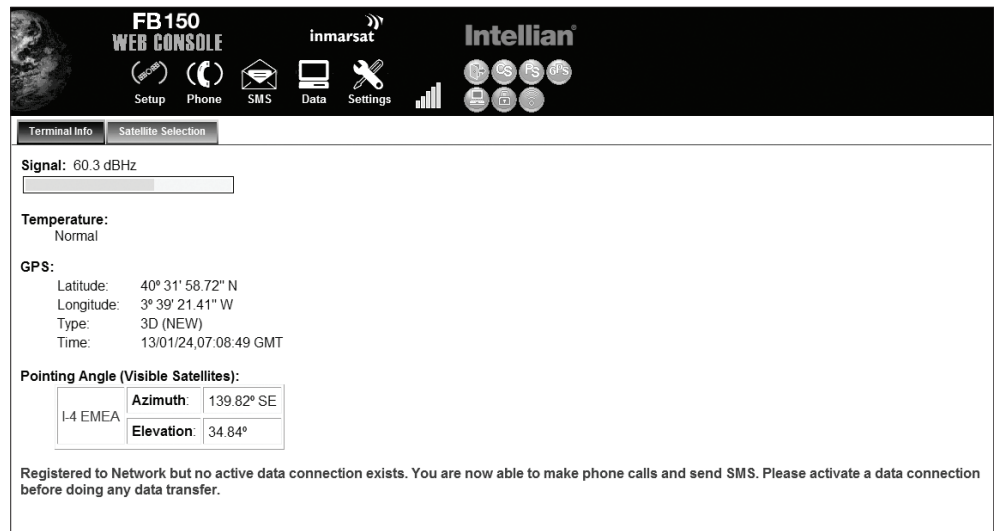

The FBB BDU will automatically register to the network. This process will include GPS acquisition, satellite tracking and registration with the network, which will take a few minutes.

Once the process is completed, you will see the following message appearing at the bottom line of the Web Console.

“Registered to Network but no active data connection exists. You are now able to make phone calls and send SMS. Please activate a data connection before doing any data transfer”

Upon successful registration, with all three BDU’s LED indicators lit in green, the UE will be ready for normal operation.

8.2 Navigating the Web Console

Menu Overview



Below you can see all of the sub menu tabs, under each icon menu item.

Setup	Phone	SMS	Data	Settings
Terminal Info	Phonebook	Compose	Connection	Language
Satellite Selection	Call History	Inbox	Primary Profiles	Terminal Info
		Sent	Port Forwarding	Ethernet
		Draft	Firewall	Telephony
			PPPoE	PIN
			Misc	SMS
			Settings	Tracking
				Admin
				Support
				Accounts
				About





Status/Action Indicators



These icons indicate the status of the FBB BDU.

- Orange indicates the item is active.
- Grey indicates the item is inactive.





Status Icons

Status Indicator	Description	
	Circuit Switch Icon	Indicates the Circuit Switch service status (Voice calls, SMS, FAX).
	Packet Switch Icon	Indicates the Packet Switch service status (Internet Browsing, FTP, email.)
	GPS Icon	Indicates if a new GPS fix is available or not.
	Tracking Mode Icon	Tracking mode is enabled. (Icon is not shown if tracking is not enabled.)

These icons indicate the status of the FBB BDU and also function as shortcut buttons to the respective menu as indicated below.

- Orange indicates the item is active.
- Grey indicates the item is inactive.

Action Status Icons

Status Indicator	Description	
	Logout Icon	Click on this icon to log out from the web console.
	Internet Icon	Indicate whether the unit is connected to the internet. Click on this icon to go to Data menu.
	CIPHERING Icon	Indicate that ciphering is enabled or disabled. Click on this icon to CIPHERING Menu.
	New message received	Indicates if a new message is received and unread. Click on this icon to go to Inbox Menu. (Icon is not shown if there is no unread message.)
	Radio Silence Icon	Indicates if radio silence is enabled or disabled. Click on this icon to trigger radio silence enable and disable.

8.3 Navigating the Web Console

Setup Menu

Viewing Terminal Information



1. Click on Setup icon.
2. Click **Terminal Info**.

The terminal information tab shows Signal strength, Temperature, GPS Status, Elevation angle and Registration status.

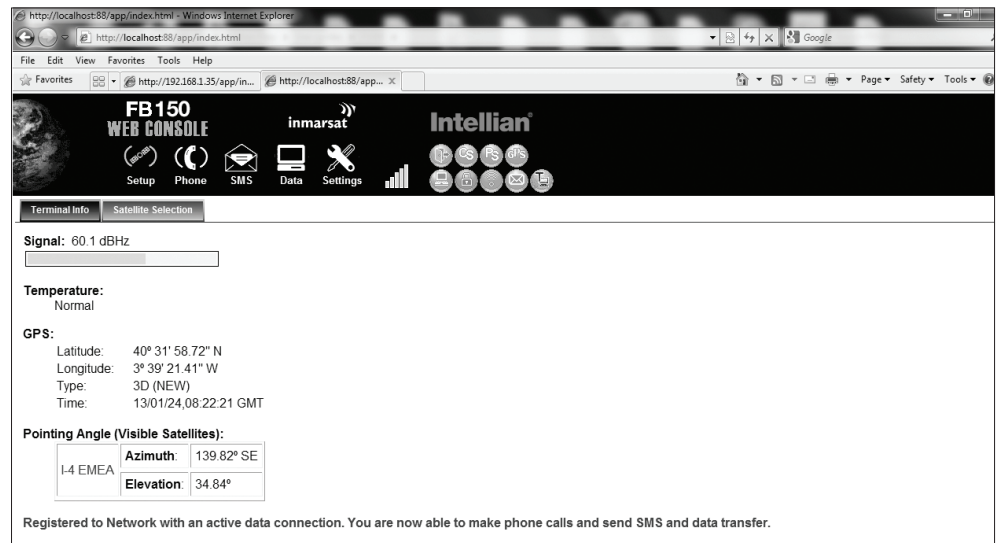

Signal	Indicates the received signal strength (C/No in dB Hz).
Temperature	Indicates the UE's current operating temperature status.
GPS	Indicates the latitude, longitude, type and time of the GPS acquisition.
Pointing Angle	Indicates the azimuth and elevation angle of the antenna with the corresponding satellite in view.

Satellite Selection

The default Satellite Selection is in **Auto** mode. In **Auto** mode, the UE will scan all the visible satellites and track the satellite with the most optimum elevation angle or the last used satellite.

Note: Changing the satellite selection will terminate any existing active voice/fax call or data connections.

Follow these steps to change your satellite selection:



1. Click on Setup icon
2. Click the **Satellite Selection** to view the visible satellites.
The visible satellites will be displayed for your selection.
It also displays the satellite information that your Antenna Unit's is locked on to.

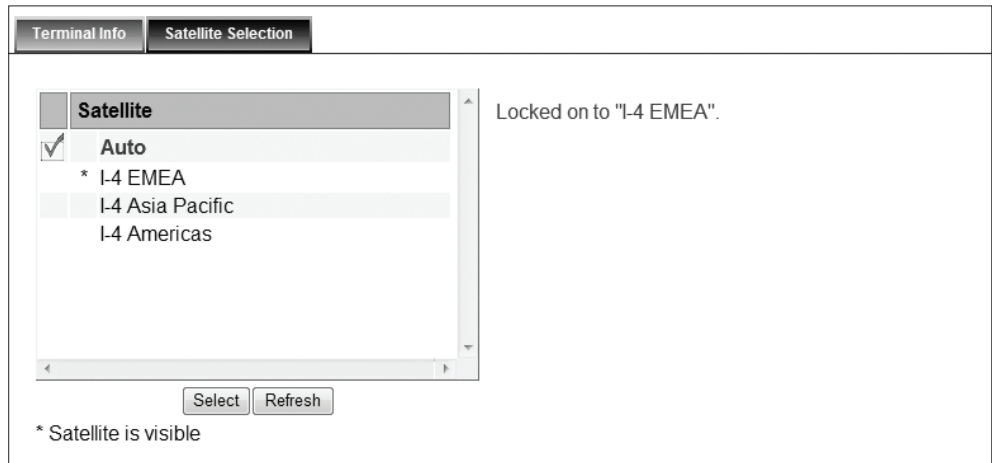

3. Click on your choice of visible satellites.
4. Click the Select button to point the antenna to the selected satellite in exclusive mode. The satellite selection will be saved, and each time you power up the UE, the satellite selection choice will remain until you make the next selection change. The UE will track the newly selected satellite even if the elevation angle is not optimum.
5. Click Refresh to refresh the Satellite list.

Phone Menu



1. Click on Phone icon

Phone menu provide the following options:

I. PhoneBook

- The Phonebook entries can be stored on the SIM card or the FBB BDU.
- Allows you to view, add, edit and delete entries on your Phonebook list.
- You can make and send SMS messages directly from your Phonebook entries.

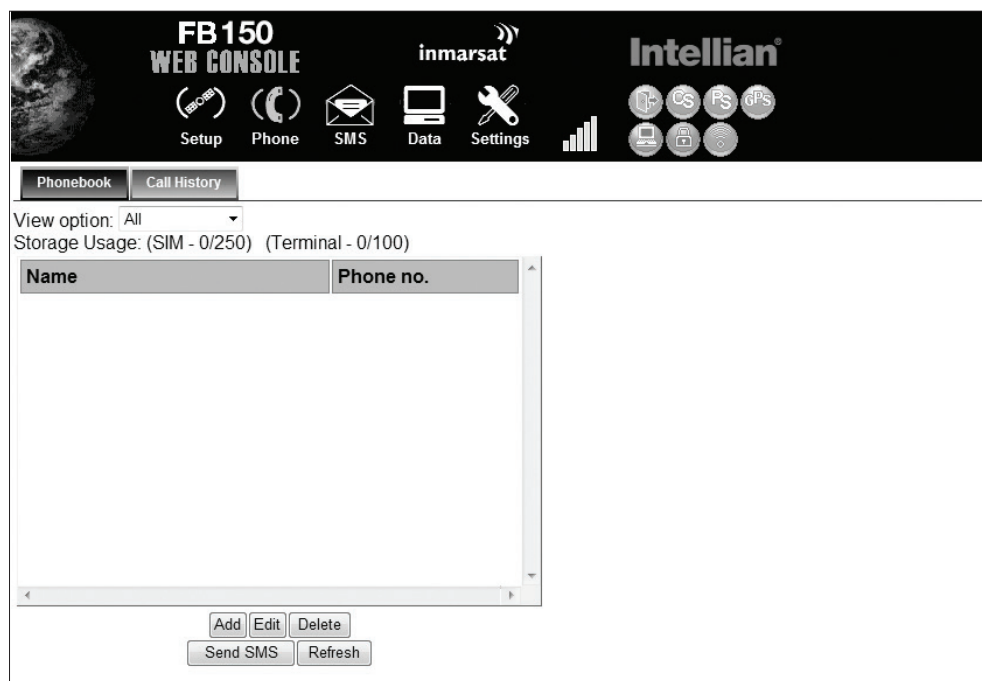

View option

The View option allows you to view the Phonebook entries from the different storage locations.

From the drop-down menu, select:

All	To view the entries stored in the SIM card and FBB BDU.
SIM only	To view the entries stored in the SIM card.
Transceiver only	To view the entries stored in the FBB BDU.

Storage Usage

Shows the number for Phonebook entries used in the SIM card and TU locations.

For example: **(SIM -2/150)** indicates: Storage location – **SIM** card

Total number of entries used = **2**

Total number of entries available = **150**

Adding Phonebook Record [X]

Name:

Phone no.:

Save Phonebook record in SIM Terminal

Adding a new Phonebook entry

- Click Add.
- Enter the Name and Phone number.
- Select the storage location and click Save.

Phonebook Edit [X]

Name:

Phone no.:

Editing a Phonebook entry

- Select the entry from the Phonebook list.
- Click Edit.
- Proceed to change the Name and/or Phone number.
- Click Apply.

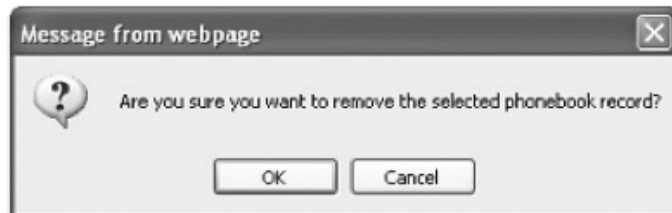

Deleting a Phonebook entry

- Select the entry from the Phonebook list
- Click Delete.
- Click Ok to confirm to delete the entry

Sending SMS from the Phonebook

Follow these steps to send SMS from the Phonebook:

1. Select the entry from the Phonebook list.
2. Click Send SMS.
3. The Phonebook console switches over to the Compose SMS console.

The screenshot shows the 'Compose' tab selected in a menu with 'Inbox', 'Sent', and 'Draft'. Below the menu, there is a 'Phone no.' field containing '+9512345678' and a character count '73 /160'. A text input area contains the message: 'Lat:+40.53298,Long:-3.65595,12/09/12,00:36:55 GMT ETA PORT SEA BOUY 22:30'. At the bottom, there are buttons for 'Send', 'Save', 'Clear', and 'Append GPS'. A checkbox labeled 'Store a sent copy in SIM' is checked.

4. Type in the text message and click Send.

II. Call History

To check history log of calls made and received.

The screenshot shows the 'Call History' tab selected in a menu with 'Phonebook'. Below the menu, there is a 'View option:' dropdown menu set to 'All'. A table displays call history with two columns: 'Phone no.' and 'Time'. The table contains one entry: 'Technical Support' with phone number '006598201820' and time '10/10/04 03:44:48'. At the bottom, there are buttons for 'Send SMS', 'Delete', and 'Refresh'.

Phone no.	Time
Technical Support 006598201820	10/10/04 03:44:48

View option

The View option allows you to view the Call History entries.
From the drop-down menu, select:

All	To view the list of the dialed, received and missed calls.
Dialed Call	To view the list of dialed calls only.
Received Call	To view the list of received calls only.
Missed Call	To view the list of missed calls only.

Sending SMS from the Call History list

Follow these steps to send SMS from the Call History list:

1. Select the entry from the list.
2. Click Send SMS.
3. The Call History console switches over to the Compose SMS console.

The screenshot shows the 'Compose' screen of a mobile application. At the top, there are four tabs: 'Compose', 'Inbox', 'Sent', and 'Draft', with 'Compose' being the active tab. Below the tabs, there is a 'Phone no.' field containing '+9512345678' and a character count '73 /160'. A large text area contains the message content: 'Lat:+40.53298,Long:-3.65595,12/09/12,00:36:55 GMT' followed by 'ETA PORT SEA BOUY 22:30'. At the bottom of the text area, there are four buttons: 'Send', 'Save', 'Clear', and 'Append GPS'. Below these buttons, there is a checkbox labeled 'Store a sent copy in SIM' which is currently checked.

4. Type in the text message and click Send.

Deleting a Call History entry

Follow these steps to delete a call History entry:

1. Select the entry from the Call History list.

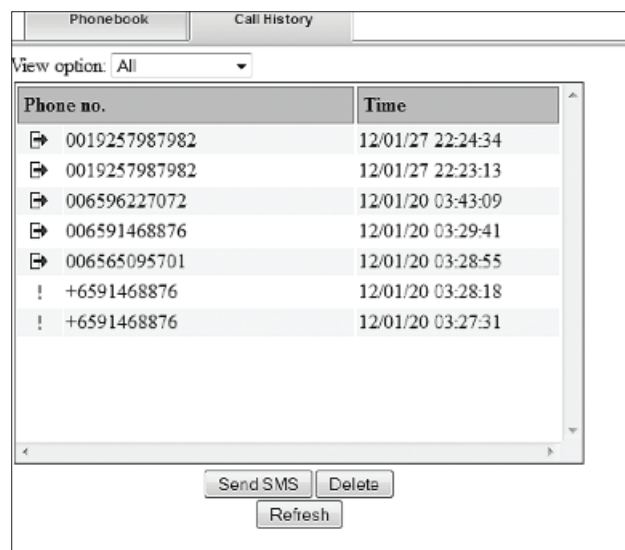

2. Click **Delete**.
3. Click **Ok** to confirm or click **Cancel** to abort deleting the entry.
4. Click Refresh to refresh the Call History list.

SMS Menu



1. Click on SMS icon.

SMS menu provide the following options:

I. Compose

To compose and send text messages.

Simply enter a mobile number, type your message and click Send.

II. Inbox

Shows the details (Sender information, Message, Date and Time stamp) of all SMS received.

III. Sent

Shows the details (Receiver information, Message, Date and Time stamp) of all SMS sent.

IV. Draft

Stores unsent messages for retrieval later.

I. Compose

Composing a New Message

Follow these steps to compose a new SMS:

1. Enter the receiver's Phone number in the Phone no. field or click the Phonebook icon if the receiver's number is listed in the Phonebook.
2. Type the message in the text editor box.

The screenshot shows the 'Compose' screen of a mobile device. At the top, there are four tabs: 'Compose', 'Inbox', 'Sent', and 'Draft'. Below the tabs, there is a 'Phone no.' field with the number '+9512345678' and a character count '73 / 160'. A text editor box contains the message: 'Lat:+40.53298, Long:-3.65595, 12/09/12, 00:36:55 GMT ETA PORT SEA BOUY 22:30'. At the bottom of the screen, there are four buttons: 'Send', 'Save', 'Clear', and 'Append GPS'. Below the buttons, there is a checkbox labeled 'Store a sent copy in SIM' which is checked.

Note: Message is limited to 160 characters (using 7 bit encoded default alphabets) including spaces between words. But it is limited to 70 characters per message using Unicode (UCS2) text message (such as message typed in Chinese, Japanese, etc). For sending a long SMS to another BGAN transceiver, the message is limited to 608 characters (using 7 bit encoded default alphabet) or 266 characters using Unicode (UCS2) text messages including spaces between words. If you do not wish to store a copy of the sent SMS into SIM card uncheck Store a copy in the SIM checkbox. Click Send to send the SMS.

3. Click the Send button to send the SMS.
4. To save an unsent SMS, click the Save button and the unsent SMS will be saved in Draft.
5. To clear the typed message on the text editor, click the Clear button.

II. Inbox

Shows the details (Sender information, Message, Date and Time stamp) of all SMS received.

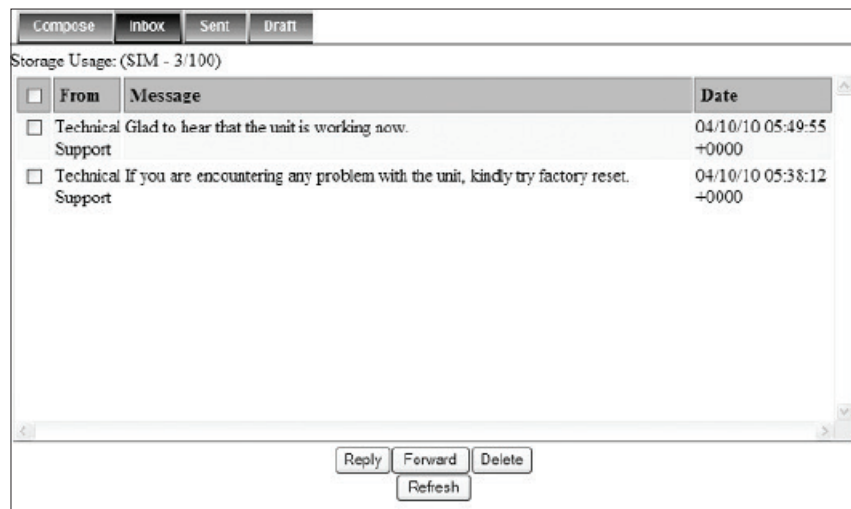

Replying to a SMS

Follow these steps to reply a SMS:

1. Click on a SMS to select it.

The selected SMS will be highlighted in light blue.

2. Click **Reply**.

3. Click **OK** to reply with the original contents or **Cancel** to reply without the original content.

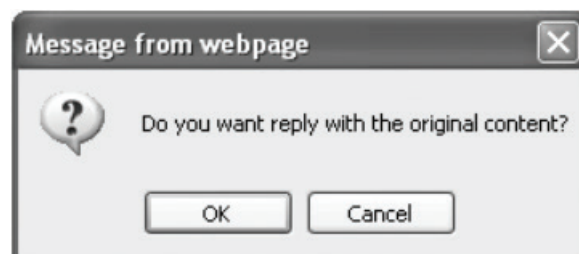

The Inbox console switches over to the Compose console.

4. Enter your reply in the text editor.

5. Click Send to send your reply SMS. The reply SMS will be sent to the recipient.

Forwarding an SMS

Follow these steps to forward an SMS:

1. Click on a SMS to select it.
The selected SMS will be highlighted in light blue.
2. Click **Forward**.
The Inbox console switches over to the Compose console.
3. Enter the receiver's number in the **Phone No.** field.
4. Click **Send** to forward the SMS. The SMS will be sent to the recipient.

Deleting a single SMS from the Inbox list

Follow these steps to delete a single SMS from the Inbox list:

1. Click on a SMS to select it.
2. Click Delete.
3. Click OK to confirm or click Cancel to abort deleting the SMS.

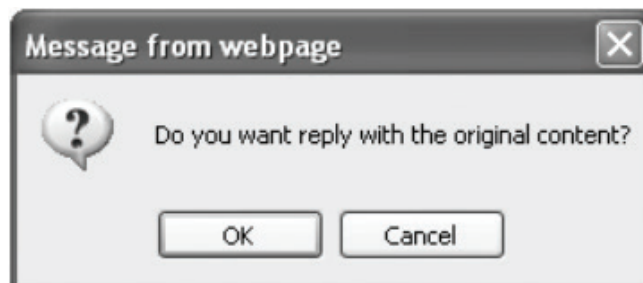

Deleting multiple SMS from the Inbox list

Follow these steps to delete multiple SMS from the Inbox list:

1. Select the message by checking the checkboxes beside each SMS.
2. Click **Delete**.
3. Click OK to confirm the delete, or Cancel to abort the delete.
4. Click Refresh to refresh the Inbox list.

III. Sent

Shows the detail (Receiver information, Message, Date and Time stamp)of all SMS sent.

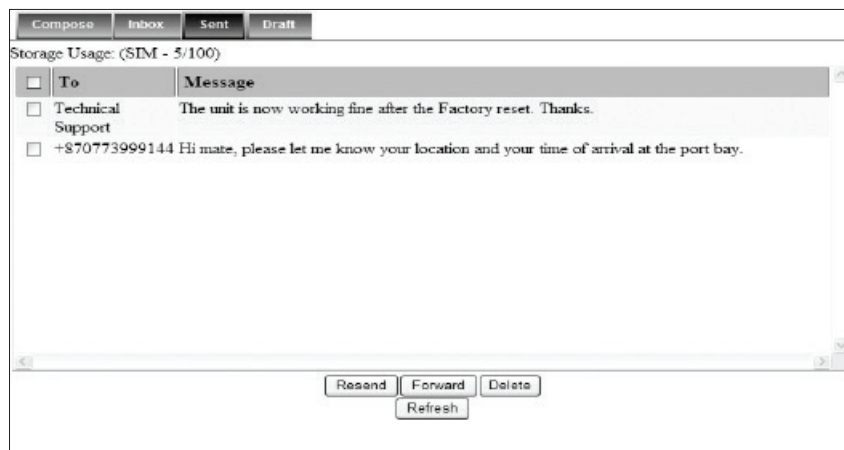

Resending a sent SMS

Follow these steps to resend a sent SMS (sending the same SMS to the same receiver):

1. Click on a SMS to select it.
2. Click Resend.
3. The SMS will be sent to the recipient.

Forwarding a sent SMS

Follow these steps to forward a sent SMS to another recipient:

1. Click on a SMS to select it.
2. Click Forward.
3. The Sent console switches over to the Compose console.

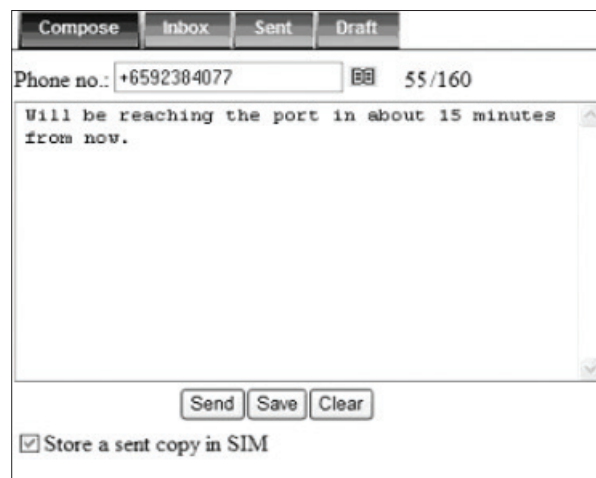

4. Enter the receiver's number in the Phone No. field.
5. Click Send. The SMS will be sent to the recipient.

Deleting a SMS from the Sent list

Follow these steps to delete a single SMS from the Sent list:

1. Click on a SMS to select it.
2. Click Delete.
3. Click OK to confirm or click Cancel to abort deleting the SMS.

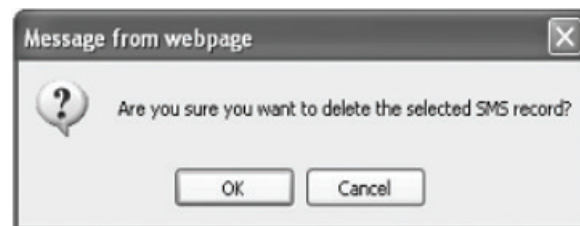

Deleting multiple SMS from the Sent list

Follow these steps to delete multiple SMS from the sent list:

1. Select the message by checking the checkboxes beside each SMS.
2. Click Delete.
3. Click OK to confirm the delete, or Cancel to abort the delete.
4. Click Refresh to refresh the Sent list.

IV. Draft

Stores SMS saved from the Compose console.



Follow these steps to send a draft SMS:

1. Click on a SMS to select it.
2. Click Send.

The SMS will be sent to the recipient.

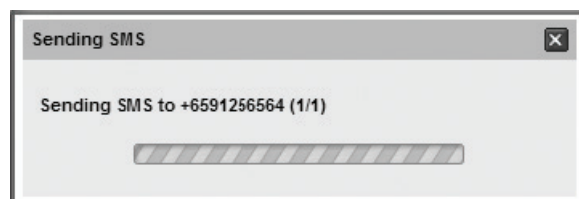

Forwarding a draft SMS another recipient

Follow these steps to forward a draft SMS to another recipient:

1. Click on a SMS to select it.
2. Click Forward.

The Draft console switches over to the Compose console.



3. Enter the receiver's number in the Phone No. Field.
4. Click Send to forward the SMS.

The SMS will be forwarded to the recipient.

Deleting a SMS from the Draft list

Follow these steps to delete a SMS from the Draft list:

1. Click on a SMS to select it.
2. Click **Delete**.
3. Click **OK** to confirm or click **Cancel** to abort deleting the SMS.

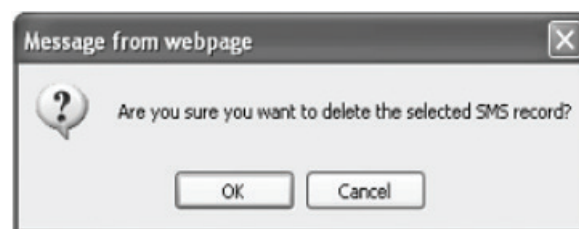

Deleting multiple SMS from the Draft list

Follow these steps to delete multiple SMS from the Draft list:

1. Select the message by checking the checkboxes beside each SMS.
2. Click Delete.
3. Click OK to confirm the delete, or Cancel to abort the delete.
4. Click Refresh to refresh the Draft list.

Data Menu



1. Click on Data icon.

Data menu provides the following options:

- I. **Connection**
- II. **Primary Profiles**
- III. **Port Forwarding**
- IV. **Firewall**
- V. **PPPoE**
- VI. **Misc**
- VII. **Settings**

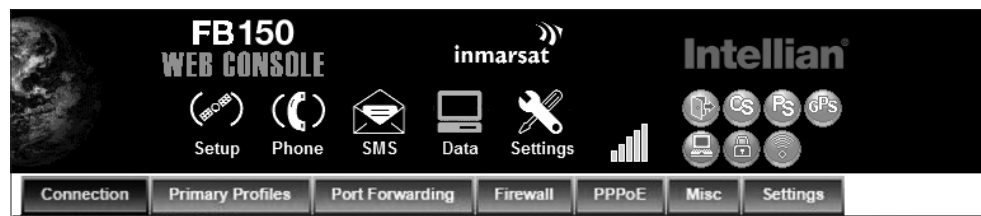

I. Connection

2. To activate the default profile, click Activate Default Profile. The PDP context will be activated.

SN	APN (Access Point Name)	IP Address	Profile Name	CID	Action	Remarks
1	BGAN.INMARSAT.COM	161.30.180.5	Standard	5	Disconnect	Primary PDP Context

[Activate Default Profile](#)

When connected, APN and the assigned public IP Address details will be displayed. You can proceed to access the Internet and use the related features.

Activate Profile

In progress...



Connection	Primary Profiles	Port Forwarding	Firewall	PPPoE	Misc
globe.bgan.inmarsat.com - 172.16.24.205 Disconnect (Standard)					

3. To disconnect the data connection, click Disconnect. The PDP context will be deactivated.

II. Primary Profiles

Primary profiles define the connection type.

You can select from a list of profiles to be the default primary profile and connection type. From Profile 7 to Profile 10, you can create your own customized primary profile.

The screenshot displays the 'Primary Profiles' configuration interface. On the left, a list of profiles is shown, with 'Standard' selected. The main area is titled 'Standard' and contains the following configuration options:

- Profile Name:** Standard
- Access Point Name (APN):** BGAN.INMARSAT.COM
- Static IP Address APN Username:** [Empty field]
- Static IP Address APN Password:** [Empty field]
- IP Configuration:** Dynamic IP Address (selected), Static IP Address
- Limited Connection:**
 - Time:** Duration: [Empty field] minutes (10 ~ 720), Notification Before Expired: [Empty field] minutes (0 ~ 8)
 - Volume:** Traffic Volume: [Empty field] MB (1 ~ 1024)

A note states: "Please note that the 'username' and 'password' stated above are not those used to login to the WebConsole. They are those provided by your Service Provider for static IP address subscription. If you do not have any such subscription or if you are not sure".

Buttons at the bottom include 'Update Settings', 'Cancel', and 'Activate Profile'.

Note: The Standard profile is set as the default primary profile and the default connection type is standard (this is charged by the volume [in kilobytes] of data used).

Profile Name

Change the profile name as desired.

Connection Type

Change the type of connection. By default the connection type will be standard.

Access Point Name (APN)

By default, the APN from the SIM will be selected.

Follow these steps to change the Access Point Name (APN):

1. Select User Defined.
2. Enter the new APN in the field space provided (e.g. BGAN inmarsat.com).
3. Enter the username and password if required.

IP Configuration

By default, the Dynamic IP Address is selected.

Follow these steps to use Static IP Address:

1. Select Static IP Address and enter the IP Address in the space provided.
2. Check the Header Compression checkbox if it is required to use Header Compression.

III. Port Forwarding

Port Forwarding is a feature for Router (multiple-user) mode.

This feature sets the FBB BDU to direct incoming traffic on certain TCP/UDP port to a specific port on a local PC (IP Address).

Incoming Port	Protocol	Destination IP Address	Destination Port	Enabled	
0	-	0.0.0.0	0	<input type="radio"/>	Add
0	-	0.0.0.0	0	<input type="checkbox"/>	Add
0	-	0.0.0.0	0	<input type="radio"/>	Add
0	-	0.0.0.0	0	<input type="checkbox"/>	Add
0	-	0.0.0.0	0	<input type="radio"/>	Add
0	-	0.0.0.0	0	<input type="checkbox"/>	Add
0	-	0.0.0.0	0	<input type="radio"/>	Add
0	-	0.0.0.0	0	<input type="checkbox"/>	Add
0	-	0.0.0.0	0	<input type="radio"/>	Add
0	-	0.0.0.0	0	<input type="checkbox"/>	Add

[Refresh](#)

Follow these steps to add a new forwarding rule:

1. Click the Add button.

Port Forwarding

Incoming Port: -

Destination IP Address: . . .

Protocol: TCP

Destination Port: -

Enabled:

[Apply](#) [Cancel](#)

2. Enter the Incoming Port number in the space provided.
(For example, the user expecting HTTP traffic, the port is 80).
3. Enter the Destination IP Address.
(For example, the IP Address of the PC that is connected to the FBB BDU).
4. Select the Protocol type TCP (e.g. for HTTP, it will be TCP) UDP.
5. Enter the Destination Port number in the space provided (For example: listening port of the particular service (for example TCP port 80 for web server) on the PC that is connected to the FBB BDU).
6. Click Apply to allow the settings to take effect.

IV. Firewall

By default, the **Firewall** is disabled.

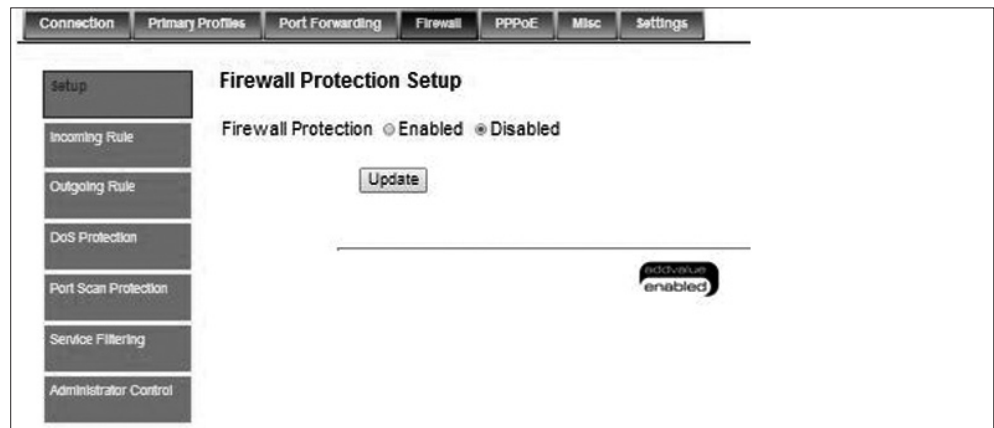

Enable Firewall Settings

1. Navigate to **Data>Firewall>Setup** to enable Firewall protection.
2. Select **Enable**.
3. Click **Update**.

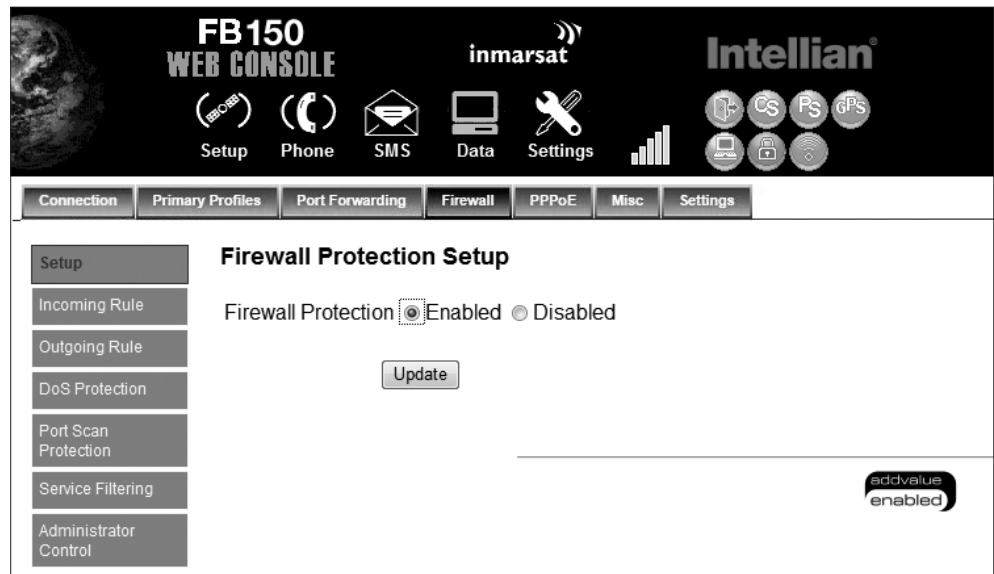

Incoming Rule

To add and define up to 10 rules to allow or reject incoming packets.

The screenshot shows the 'Incoming Rule' configuration page. At the top, there are tabs for 'Connection', 'Primary Profiles', 'Port Forwarding', 'Firewall', 'PPPoE', 'Misc', and 'Settings'. The 'Firewall' tab is active. On the left, a sidebar contains navigation options: 'Setup', 'Incoming Rule', 'Outgoing Rule', 'DoS Protection', 'Port Scan Protection', 'Service Filtering', and 'Administrator Control'. The main area is titled 'Incoming Rule' and shows the 'Default Action for Incoming Packets' set to 'Accept'. Below this is a table with columns: 'Rule Name', 'Protocol', 'Source IP Address', 'Source Port', 'Destination IP Address', 'Destination Port', 'Action', and 'Enabled'. The first row is the 'Default Rule' with 'ANY' for all fields, 'Allow' action, and 'Enabled' checked. Below it are eight empty rows, each with an 'Add' button. At the bottom, there are 'Refresh' and 'Update' buttons.

Rule Name	Protocol	Source IP Address	Source Port	Destination IP Address	Destination Port	Action	Enabled
Default Rule	ANY	ANY	ANY	ANY	ANY	Allow	<input checked="" type="checkbox"/>
							<input type="checkbox"/> Add
							<input type="checkbox"/> Add
							<input type="checkbox"/> Add
							<input type="checkbox"/> Add
							<input type="checkbox"/> Add
							<input type="checkbox"/> Add
							<input type="checkbox"/> Add
							<input type="checkbox"/> Add

This screenshot shows the same 'Incoming Rule' configuration page, but with a dialog box titled 'Add Incoming Firewall Rule' open. The dialog box contains the following fields: 'Rule Name' (Rule 1), 'Protocol' (radio buttons for TCP, UDP, ICMP, and selected ANY), 'Source IP Address' (IP input field), 'Source Port' (p - p input field), 'Destination IP Address' (IP input field), 'Destination Port' (p - p input field), 'Action' (radio buttons for Allow and selected Reject), and 'Enabled' (checked checkbox). There are 'Apply' and 'Cancel' buttons at the bottom of the dialog. A note at the bottom of the dialog reads: 'Note: IP Addresses, Ports with value 0 means ANY. eg. IP (0.0.0.0 - 0.0.0.0) means ANY IP. Port (0 - 0) means ANY Port.' The background configuration page is dimmed.

Outgoing Rule

To add and define up to 10 rules to allow or reject outgoing packets.

The screenshot shows the 'Outgoing Rule' configuration page. At the top, there are tabs for 'Connection', 'Primary Profiles', 'Port Forwarding', 'Firewall', 'PPPoE', 'Misc', and 'Settings'. The 'Firewall' tab is active. On the left, there is a sidebar with navigation options: 'Setup', 'Incoming Rule', 'Outgoing Rule', 'DoS Protection', 'Port Scan Protection', 'Service Filtering', and 'Administrator Control'. The main area is titled 'Outgoing Rule' and has a 'Default Action for Outgoing Packets' set to 'Accept'. Below this is a table with columns: 'Rule Name', 'Protocol', 'Source IP Address', 'Source Port', 'Destination IP Address', 'Destination Port', 'Action', and 'Enabled'. The first row is the 'Default Rule' with 'ANY' for all fields and 'Allow' for Action. Below it are seven empty rows, each with an 'Add' button. At the bottom, there are 'Refresh' and 'Update' buttons.

Rule Name	Protocol	Source IP Address	Source Port	Destination IP Address	Destination Port	Action	Enabled
Default Rule	ANY	ANY	ANY	ANY	ANY	Allow	<input checked="" type="checkbox"/>
							<input type="checkbox"/> Add
							<input type="checkbox"/> Add
							<input type="checkbox"/> Add
							<input type="checkbox"/> Add
							<input type="checkbox"/> Add
							<input type="checkbox"/> Add
							<input type="checkbox"/> Add

This screenshot shows the same 'Outgoing Rule' configuration page, but with the 'Add Outgoing Firewall Rule' dialog box open. The dialog box has fields for: 'Rule Name' (Rule 1), 'Protocol' (radio buttons for TCP, UDP, ICMP, and selected ANY), 'Source IP Address' (IP address input), 'Source Port' (port range input), 'Destination IP Address' (IP address input), 'Destination Port' (port range input), 'Action' (radio buttons for Allow and selected Reject), and 'Enabled' (checkbox checked). There are 'Apply' and 'Cancel' buttons at the bottom of the dialog. A note at the bottom of the dialog reads: 'Note: IP Addresses, Ports with value 0 means ANY. eg. IP (0.0.0.0 - 0.0.0.0) means ANY IP, Port (0 - 0) means ANY Port.' The background configuration page is dimmed.

DoS Protection

To protect the terminal and the private network against unnecessary DoS attacks from the untrusted public network by:

- a. Block packets with spoofed source IP addresses from public network (protects against LAND attack and others that use reserved/private source IP addresses).
- b. Block broadcast packets from public network (protects against Smurf and Fraggle type flooding attacks). By default, the DoS is disabled.

The screenshot shows the 'DoS Protection' configuration page. The status is set to 'Disabled'. The page is divided into two main sections: 'Block packets with spoofed source IP addresses from public network' and 'Block broadcast packets from public network'. Each section contains a list of checkboxes for various IP address ranges and types.

Section	Option	IP Range
Block packets with spoofed source IP addresses from public network	<input type="checkbox"/>	Block packets from Historical Broadcast addresses (0.0.0.0/8)
	<input type="checkbox"/>	Block packets from Unallocated and Broadcast addresses (248.0.0.0/5)
	<input type="checkbox"/>	Block packets from RFC 1918 Class A private addresses (10.0.0.0/8)
	<input type="checkbox"/>	Block packets from RFC 1918 Class B private addresses (172.16.0.0/12)
	<input type="checkbox"/>	Block packets from RFC 1918 Class C private addresses (192.168.0.0/16)
	<input type="checkbox"/>	Block packets from Class D Multicast addresses (224.0.0.0/4)
	<input type="checkbox"/>	Block packets from Class E Reserved addresses (240.0.0.0/5)
	<input type="checkbox"/>	Block packets from Link Local addresses (169.254.0.0/16)
	<input type="checkbox"/>	Block packets from TEST-NET addresses (192.0.2.0/24)
	<input type="checkbox"/>	Block packets claiming to be from our own private network
Block broadcast packets from public network	<input type="checkbox"/>	Block packets (sent) to limited broadcast address (255.255.255.255/32)
	<input type="checkbox"/>	Block packets (sent) to public network broadcast address

Port Scan Protection

To protect the terminal from port scanning attacks by blocking packets with illegal TCP flag or illegal TCP flag combinations from public network (protects against Xmas scan, NULL scan and similar types of port scanning).

By default, the Port Scan Protection is disabled.

The screenshot shows the 'Port Scan Protection' configuration page. The status is set to 'Disabled'. The page contains a list of checkboxes for various illegal TCP flag combinations.

Option	Description
<input type="checkbox"/>	Block packets with all flags set - XMAS Scan
<input type="checkbox"/>	Block packets with no flags set - NULL Scan
<input type="checkbox"/>	Block packets with SYN and FIN set
<input type="checkbox"/>	Block packets with SYN and RST set
<input type="checkbox"/>	Block packets with FIN and RST set
<input type="checkbox"/>	Block packets with FIN set, but ACK not set
<input type="checkbox"/>	Block packets with PUSH set, but ACK not set
<input type="checkbox"/>	Block packets with URG set, but ACK not set

Service Filtering

To prevent external network accessing the terminal by blocking packets such as Ping, Telnet, access web console and access to AT command service. By default, the Service Filtering is disabled.

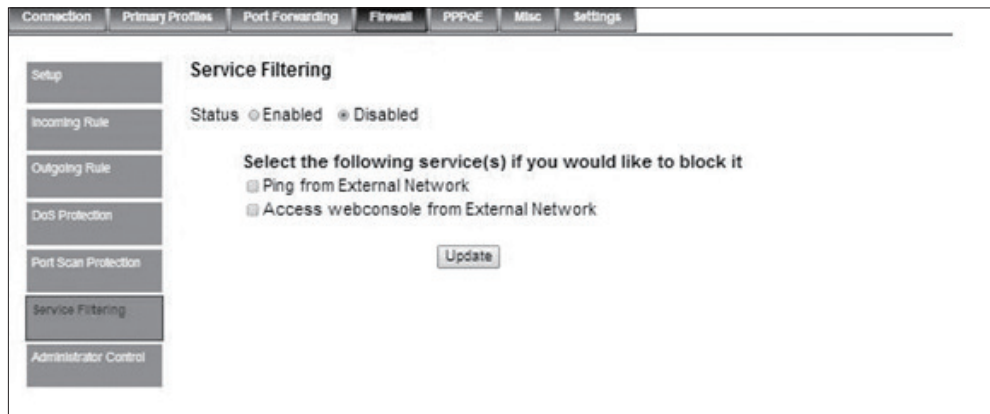

Administrator Control

To block any keyword in the content of the accessing page.

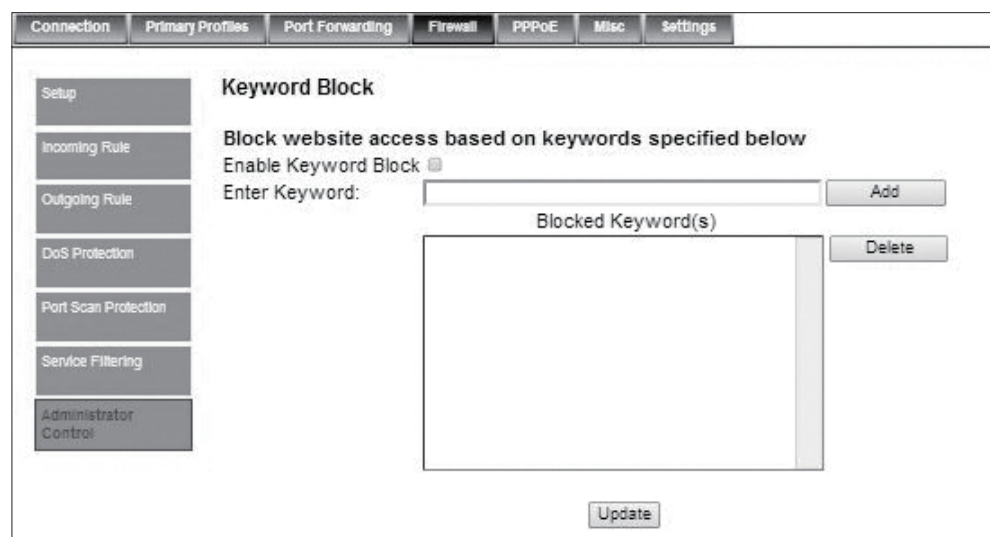

V. PPPoE

By default, the PPPoE is disabled.



1. Select Enable.
2. Click Update.
3. Once the PPPoE service is enabled, a pop-up message box indicates the PPPoE service is activated and requires rebooting of terminal for the service to take effect

VI. Misc

This feature requires the activation of the next PDP to take effect. User has to enable the VPN Passthrough first then activate the PDP context.

1. Select IPsec or PPTP.
2. Click Update.



3. Once the required option is updated, a pop-up message box indicates the the update is successful. Reboot terminal for the service to take effect

VII. Setting

You can select the Ethernet mode to be used for data connection.

Connection	Primary Profiles	Port Forwarding	Firewall	PPPoE	Misc	Settings
<p>Ethernet mode:</p> <ul style="list-style-type: none"> <input type="radio"/> Router Mode (Single User) <input checked="" type="radio"/> Router Mode (Multi-User) <ul style="list-style-type: none"> <input checked="" type="checkbox"/> Always On (Auto PDP Context Activation) <p>Default Primary Profile: <u>Standard</u></p> <p>IP Configuration:</p> <ul style="list-style-type: none"> <input type="checkbox"/> Use Header Compression <p>Note: Changes only take effect after terminal reboots</p> <p style="text-align: center;"> <input type="button" value="Update"/> <input type="button" value="Refresh"/> </p>						

Follow these steps to select the Ethernet mode:

1. Select the desired mode to be used during the data connection:
 - Router (Single User) is with NAT/PAT disabled.
 - Router (Multi-User) is with NAT/PAT enabled for multi-user.

Note: You cannot change the Router settings while a Data connection is active, you must first disconnect your Data session.

2. Check “Always On (Auto PDP Context Activation)” if required.
3. Check “ Use Header Compression” if you want UDP packet data to be compressed.

Note: this change will only take effect from next boot up.

4. Click Update to allow the selection to take effect.
5. Click Refresh to query the current mode.

Settings Menu

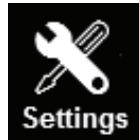

1. Click on Settings icon.
Setting menu provides the following options:

- I. Language**
- II. Terminal Info**
- III. Ethernet**
- IV. Telephony**
- V. PIN**
- VI. SMS**
- VII. Tracking**
- VIII. Admin**
- IX. Support**
- X. Accounts**
- XI. About**

I. Language

Select the desired language for the Web Console to be displayed. (Spanish, Chinese-Simplified and Chinese-Traditional may not be an option that is available at the time of purchase).

Language	Terminal Info	Ethernet	Telephony	PIN	SMS	Tracking	Admin	Support	Accounts	About
<input checked="" type="radio"/> English										
<input type="radio"/> 简体中文										
<input type="radio"/> 繁體中文										
<input type="radio"/> Español										
<input type="radio"/> Dutch										
<input type="radio"/> 日本語										
<input type="radio"/> 한국어										
<input type="button" value="Apply"/>										

II. Terminal Info

This tab shows general information about the UE, Error/Event Logos and Call Logs.

Information

Displays information about the Manufacture ID, Software version, Model ID, IMEI number, IMSI number (only when a SIM card is inserted), Subscriber number and Antenna Unit's serial number.

Language	Terminal Info	Ethernet	Telephony	PIN	SM\$	Tracking	Admin	Support	Accounts	About
Information										
Logs										
Call Log										
Call/Data Usage										
Manufacture ID:	Addvalue									
Software Version:	Webconsole Emulator_1.0.1									
Hardware Version:										
Model ID:	Webconsole Emulator									
IMEI Number:	3559260300040301									
IMSI Number:	901112112100154									
Subscriber Number:	+871234567									
BDU Serial Number:	EB250SA091199999									
MAC Address:	20:6A:8A:3B:CC:BD									
ADU:										

Logs

Displays event and error logs of the UE.

Language	Terminal Info	Ethernet	Telephony	PIN	SM\$	Tracking	Admin	Support	Accounts	About
Information										
Logs										
Call Log										
Call/Data Usage										
Log Type: <input type="text" value="Event"/>										
Date/Time	Logs									
Fri Jan 27 2012, 23:25:19 -0800	Primary PDP context activation succeeded 5[5]									
Fri Jan 27 2012, 23:25:13 -0800	UE initiated a Primary PDP context activation 5[5]									
Fri Jan 27 2012, 22:25:42 -0800	Call has ended									
Fri Jan 27 2012, 22:24:34 -0800	Outgoing call in progress									
Fri Jan 27 2012, 22:23:56 -0800	Call has ended									
Fri Jan 27 2012, 22:23:13 -0800	Outgoing call in progress									
Fri Jan 27 2012, 21:58:29 -0800	Combined Attach Success									
<input type="button" value="Delete All"/> <input type="button" value="Export All Logs"/>										

Call Log

Displays the call history including standard voice calls, high-quality / fax calls, standard data sessions. (By default, Pin is "0000")

Language	Terminal Info	Ethernet	Telephony	PIN	SMS	Wi-Fi	Tracking	Admin	Support	Accounts	About
Information	PIN <input type="text"/>										
Logs	<input type="button" value="Retrieve"/>										
Call Log											
Call/Data Usage											

User can retrieve choose to delete or export the CS or PS logs in this menu.

Call Log Type: **CS** ▼

Index	Phone no.	Call Service	Call Type	Date/Time	Duration	Cause
1	+6591132319	Standard	Incoming	Thu Nov 21 2013, 10:52:15 +0800	000:00:00:14	Normal
2	006591132319	Standard	Outgoing	Thu Nov 21 2013, 10:51:43 +0800	000:00:00:12	Normal
3	+6591132319	Standard	Incoming	Thu Nov 21 2013, 10:51:07 +0800	000:00:00:10	Normal
4	006591132319	Standard	Outgoing	Thu Nov 21 2013, 10:50:29 +0800	000:00:00:11	Normal
5	+6566347090	High Quality	Incoming	Thu Nov 21 2013, 10:44:32 +0800	000:00:02:18	Normal
6	006566347090	High Quality	Outgoing	Thu Nov 21 2013, 10:40:35 +0800	000:00:02:11	Normal
7	006565093975	Standard	Outgoing	Thu Nov 21 2013, 10:29:38 +0800	000:00:04:38	Normal
8	+6591550204	Standard	Incoming	Thu Nov 21 2013, 10:15:11 +0800	000:00:00:12	Normal

Call / Data Usage

Displays the total call usage and total data usage.

Click clear to reset counter.

Language	Terminal Info	Ethernet	Telephony	PIN	SMS	Tracking	Admin	Support	Accounts	About
Information	Total Call Usage: 00:00:00 <input type="button" value="Clear"/>									
Logs	Total Data Usage: 0 byte <input type="button" value="Clear"/>									
Call Log										
Call/Data Usage										

III. Ethernet

1. Click Ethernet to view and edit the Ethernet settings.
2. Click Update to allow the settings to take effect.

DHCP

1. Click **DHCP** to view and edit the DHCP settings.
2. Click **Update** to allow the settings to take effect.

Mac Address Filtering

1. Click Mac Filtering to view and edit the Mac Filtering settings.
2. Click Update to allow the settings to take effect.

3. Click Update to allow the settings to take effect.

Reject List

All PCs/Laptops will be allowed to access the TU except for those (MAC addresses) listed in the Reject List.

Reject List

11:22:33:44:55:66 [Delete](#)

[Add](#)

*Your MAC Address: **98:76:54:32:10:12**

Allow List

All PCs/Laptops will be denied access to the TU except for those (MAC addresses) listed in the Allow List. When selecting this list, at least one entry should be there to access the TU.

Allowed List

66:55:44:33:22:11 [Delete](#)

[Add](#)

*Your MAC Address: **98:76:54:32:10:12**

Static Route

Users can configure the static route to create a new entry route in the router's routing table. It allows the network to forward packets to the IP address destination stored in the routing table.

The screenshot shows a web interface with a navigation bar at the top containing tabs for Language, Terminal Info, Ethernet, Telephony, PIN, SMS, Tracking, Admin, Support, Accounts, and About. On the left side, there is a sidebar menu with options for Ethernet, DHCP, MAC Filtering, and Static Route. The main area displays a table with the following columns: Destination, Netmask, Gateway, and Enabled. The table contains several rows, with the first three rows having data: (1.2.3.4, 5.6.7.8, 9.0.1.2), (1.2.3.4, 5.6.7.8), and (1.2.3.4, 5.6.7.8, Terminal IP Address). Each row has an 'Enabled' checkbox and 'Edit' and 'Delete' links. Below the table, there are multiple 'Add' buttons, with the first one highlighted by a red box. A 'Refresh' button is located at the bottom right of the table area.

Destination	Netmask	Gateway	Enabled	
1.2.3.4	5.6.7.8	9.0.1.2	<input checked="" type="checkbox"/>	Edit Delete
1.2.3.4	5.6.7.8		<input checked="" type="checkbox"/>	Edit Delete
1.2.3.4	5.6.7.8		<input checked="" type="checkbox"/>	Edit Delete
1.2.3.4	5.6.7.8	Terminal IP Address	<input checked="" type="checkbox"/>	Edit Delete
			<input type="checkbox"/>	Add
			<input type="checkbox"/>	Add
			<input type="checkbox"/>	Add
			<input type="checkbox"/>	Add
			<input type="checkbox"/>	Add
			<input type="checkbox"/>	Add
			<input type="checkbox"/>	Add
			<input type="checkbox"/>	Add
			<input type="checkbox"/>	Add
			<input type="checkbox"/>	Add
			<input type="checkbox"/>	Add
			<input type="checkbox"/>	Add
			<input type="checkbox"/>	Add
			<input type="checkbox"/>	Add
			<input type="checkbox"/>	Add
			<input type="checkbox"/>	Add

The screenshot shows the configuration form for a static route. It includes a navigation bar at the top with tabs for Language, Terminal Info, Ethernet, Telephony, PIN, SMS, Tracking, Admin, Support, Accounts, and About. On the left side, there is a sidebar menu with options for Ethernet, DHCP, MAC Filtering, and Static Route. The main area displays the configuration form with the following fields: Enabled (checkbox checked), Destination (2 . 2 . 2 . 2), Netmask (255 . 255 . 0 . 0), Gateway (radio buttons for Manual and Auto Detect (Dynamic), with Manual selected), and a dropdown menu for Terminal IP Address. At the bottom, there are 'Add' and 'Cancel' buttons, with the 'Add' button highlighted by a red box.

Click Add to allow the settings to take effect.

IV. Telephony

Language	Terminal Info	Ethernet	Telephony	PIN	SMS	Tracking	Admin	Support	Accounts	About
Interface	Telephone Interface Configurations: US Caller Line ID Phone connected									
Port Configuration	<input type="button" value="Update"/>									
Caller ID										
Call Waiting										
Call Barring										
Call Forwarding										
Call Restriction										

Interface

1. Select European Caller Line ID Phone connected or US Caller Line ID Phone connected from the Telephone Interface Configuration drop-down menu.
2. Click Update to allow the setting to take effect.

Port Configuration

For each of the 3 ports, a choice of the quality calls can be selected. Select your ideal call quality and click **Update**.

Primary Handset

Port	Call Type	Service Type	Enable External Ringing?	
Primary Handset	Incoming Call	Standard voice call Standard voice call	<input type="checkbox"/>	Update
	Outgoing Call	None Standard voice call		Update

Phone Port

PHONE Port	Incoming Call	Standard voice call	<input type="checkbox"/>	Update
	Outgoing Call	Standard voice call		Update

Fax Port

For the fax port, if no subscription is made, there will be no choices.

FAX Port	Incoming Call	None ▾	<input type="checkbox"/>	Update
	Outgoing Call	None ▾		Update

If fax subscription is made, 3.1 KHz high quality fax call will be available.

FAX Port	Incoming Call	3.1kHz high quality voice/fax call ▾ 3.1kHz high quality voice/fax call None		Update
	Outgoing Call	3.1kHz high quality voice/fax call ▾ 3.1kHz high quality voice/fax call None		Update

Caller ID

1. Click **Retrieve** to get current setting of the **Allow called party to see your number configuration**.
2. To change the setting, select **Yes**, **No**, or **According to network subscription** for the **Allow called party to see your number configuration**.
3. Click **Apply** to allow the setting to take effect.

Language	Terminal Info	Ethernet	Telephony	PIN	SMS	Tracking	Admin	Support	Accounts	About
Interface	Port Configuration	Caller ID	Call Waiting	Call Barring	Call Forwarding	Call Restriction				
Allow called party to see your number? <input type="radio"/> Yes <input type="radio"/> No <input checked="" type="radio"/> According to network subscription										
<input type="button" value="Retrieve"/> <input type="button" value="Apply"/>										
										

Call Waiting

1. Click **Retrieve** to get current setting of the **Enable call-waiting** configuration.
2. To change the setting, select **Yes** or **No** for the **Enable call waiting** configuration.
3. Click **Apply** to allow the new setting to take effect.

Language	Terminal Info	Ethernet	Telephony	PIN	SMS	Tracking	Admin	Support	Accounts	About
Interface	Enable call waiting?									
Port Configuration	<input type="radio"/> Yes									
Caller ID	<input type="radio"/> No									
Call Waiting	<input type="button" value="Retrieve"/> <input type="button" value="Apply"/>									
Call Barring										
Call Forwarding										
Call Restriction										

Call Barring

1. Click any individual **Retrieve** option to get the current setting of the corresponding scenario in which the calls would be barred.
2. Select the scenario in which the calls would be barred, or deselect the scenario to disable the corresponding call barring.
3. In the **Barring PIN** field, input a PIN for call barring setup.
4. Click **Apply** to allow the corresponding setting to take effect.
5. Clicking **Retrieve All** will retrieve the current settings of all four call barring scenarios at the same time.
6. Clicking **Apply All** will allow the settings of all four call barring scenarios to take effect at the same time.

Language	Terminal Info	Ethernet	Telephony	PIN	SMS	Tracking	Admin	Support	Accounts	About
Interface	<input type="checkbox"/> Bar all outgoing calls									<input type="button" value="Retrieve"/> <input type="button" value="Apply"/>
Port Configuration	<input type="checkbox"/> Bar all outgoing international calls except those directed to the home country									Barring PIN: <input type="text"/>
Caller ID	<input type="checkbox"/> Bar all incoming calls when roaming outside the home country									<input type="button" value="Retrieve"/> <input type="button" value="Apply"/>
Call Waiting	<input type="checkbox"/> Bar all incoming calls									<input type="button" value="Retrieve"/> <input type="button" value="Apply"/>
Call Barring	<input type="button" value="Retrieve All"/> <input type="button" value="Apply All"/>									
Call Forwarding										
Call Restriction										

Call forwarding

1. Click any individual **Retrieve** option to get current setting of the corresponding scenario in which incoming calls would be forwarded.
2. Select the scenario in which the calls should be forwarded, or deselect the scenario to disable the corresponding call forwarding setting.
3. In the **Divert to Number** field, input the phone number where the incoming calls should be forwarded to (+<country code><telephone number>).
4. If the **Divert if not answered** option is selected, select from the **Divert After (seconds)** drop- down list, the period of time the network should wait before forwarding the calls.
5. Click **Apply** to allow the setting to take effect.
6. Clicking **Retrieve All** will retrieve the current settings of all four scenarios in which the calls would be forwarded, at the same time.
7. Clicking **Apply All** will allow the settings of all four scenarios to take effect at the same time.

Language	Terminal Info	Ethernet	Telephony	PIN	SMS	Tracking	Admin	Support	Accounts	About
Interface			Divert To Number	Divert After (seconds)						
Port Configuration	<input type="checkbox"/> Divert all calls		<input type="text"/>				Retrieve	Apply		
Caller ID	<input type="checkbox"/> Divert if busy		<input type="text"/>				Retrieve	Apply		
Call Waiting	<input type="checkbox"/> Divert if not answered		<input type="text"/>	30	▼		Retrieve	Apply		
Call Barring	<input type="checkbox"/> Divert if out of reach		<input type="text"/>				Retrieve	Apply		
Call Forwarding										
Call Restriction										
							Retrieve All	Apply All		

Call Restriction

The Call Restriction is only enabled for outgoing call.

There are 2 types of restriction:

1. Phonebook - The user is only able to make outgoing calls from the phonebook list.
2. Call List - In this segment, it further categorised into Allowed List and Blocked List for the 3 types of telephony functions.

a. Allowed List - The administrator can either enter the telephone numbers or simply the country and/or area code to limit other users to make outgoing calls. If the administrator can only enter one number or country code, users can only call this number or within the country.

b. Blocked List - Similar to the Allowed List, once the number or country and/or area code is entered, users are unable to make any outgoing calls through the number or within the country and/or area code specified in the list.

I. Select **Enabled** or **Disabled** to activate or deactivate call restriction respectively.

II. Select **Call List** or **Phonebook** to choose which directory you want to be restricted by.

III. Select **Allowed List** or **Blocked List** for each of the 3 ports to choose if that particular port numbers are the allowed or block list.

The screenshot shows a web interface with a navigation bar at the top containing tabs: Language, Terminal Info, Ethernet, Telephony, PIN, SMS, Tracking, Admin, Support, Accounts, and About. The 'Telephony' tab is selected. On the left, there is a sidebar menu with options: Interface, Port Configuration, Caller ID, Call Waiting, Call Barring, Call Forwarding, and Call Restriction. The 'Call Restriction' option is highlighted. The main content area displays the following configuration options:

- Call Restriction:** Enabled Disabled
- Restrict By:** Call List Phonebook
- Primary Handset:** Use as Allowed List Blocked List
 - Input fields: 0234567890, 10234567890
 - Input fields: 1234567890, 11234567890
 - Input fields: 2234567890, 12234567890
- RJ11 PHONE Port:** Use as Allowed List Blocked List
 - Input fields: 0234567890, 10234567890
 - Input fields: 1234567890, 11234567890
 - Input fields: 2234567890, 12234567890
- RJ11 FAX Port:** Use as Allowed List Blocked List
 - Input fields: 0234567890, 10234567890
 - Input fields: 1234567890, 11234567890
 - Input fields: 2234567890, 12234567890

V. PIN

Terminal PIN

1. Click Transceiver PIN to configure the Transceiver PIN settings.
2. Select **Disabled** if you do not need to set the Transceiver PIN.
3. Select **Enabled** to set the Transceiver PIN.
4. Enter the PIN number in the Enter PIN field and click **Update PIN**.

Follow these steps to change the Transceiver PIN:

1. Enter the old PIN number in the Enter Old PIN field.
2. Enter the new PIN number in the Enter New PIN field.
3. Re-enter the new PIN number in the Re-enter New PIN field.
4. Click Change PIN Password.

The Transceiver PIN is now changed.

Note: The default Terminal PIN is “0000”

Language	Terminal Info	Ethernet	Telephony	PIN	SMS	Tracking	Admin	Support	Accounts	About
Terminal PIN	Terminal PIN									
SIM PIN	<input checked="" type="radio"/> Enabled <input type="radio"/> Disabled									
SIM PIN2	Enter PIN: <input type="text"/> <input type="button" value="Apply"/>									
Change PIN Password:										
Enter Old PIN: <input type="text"/>										
Enter New PIN: <input type="text"/>										
Re-enter New PIN: <input type="text"/>										
<input type="button" value="Change PIN Password"/>										

SIM PIN

1. Click SIM PIN to configure the SIM PIN settings.
2. Select Disabled if you do not need to set the SIM PIN.
3. Select Enabled to set the SIM PIN.
4. Enter the PIN number in the space provided and click Update PIN.

Note: The SIM PIN depends on the SIM card. Consult your equipment distributor if necessary.

Language	Terminal Info	Ethernet	Telephony	PIN	SMS	Tracking	Admin	Support	Accounts	About
----------	---------------	----------	-----------	------------	-----	----------	-------	---------	----------	-------

Terminal PIN	SIM PIN
SIM PIN	<input checked="" type="radio"/> Enabled <input type="radio"/> Disabled
SIM PIN2	Enter PIN: <input type="text"/>
	<input type="button" value="Apply"/>
	Change PIN Password:
	Enter Old PIN: <input type="text"/>
	Enter New PIN: <input type="text"/>
	Re-enter New PIN: <input type="text"/>
	<input type="button" value="Change PIN Password"/>

SIM PIN2

1. Click SIM PIN2 to configure the SIM PIN2 settings.
2. Select **Disabled** if you do not need to set the SIM PIN2.
3. Select **Enabled** to set the SIM PIN2.
4. Enter the PIN number in the space provided and click **Update PIN**.

Follow these steps to change the PIN Password:

1. Enter the old PIN number in the Enter Old PIN field.
2. Enter the new PIN number in the Enter New PIN field.
3. Re-enter the new PIN number in the Re-enter New PIN field.
4. Click Change PIN Password.
5. The Transceiver PIN is now changed.

Note: The SIM PIN2 depends on the SIM card. Consult your equipment distributor if necessary.

Language	Terminal Info	Ethernet	Telephony	PIN	SMS	Tracking	Admin	Support	Accounts	About
----------	---------------	----------	-----------	------------	-----	----------	-------	---------	----------	-------

<div style="border: 1px solid gray; padding: 2px; margin-bottom: 5px;">Terminal PIN</div> <div style="border: 1px solid gray; padding: 2px; margin-bottom: 5px;">SIM PIN</div> <div style="border: 1px solid gray; padding: 2px;">SIM PIN2</div>	<p>SIM PIN2</p> <p> <input checked="" type="radio"/> Enabled <input type="radio"/> Disabled </p> <p>Enter PIN: <input style="width: 100px;" type="text"/></p> <p style="text-align: center;"><input type="button" value="Apply"/></p> <p>Change PIN Password:</p> <p>Enter Old PIN: <input style="width: 100px;" type="text"/></p> <p>Enter New PIN: <input style="width: 100px;" type="text"/></p> <p>Re-enter New PIN: <input style="width: 100px;" type="text"/></p> <p style="text-align: center;"><input type="button" value="Change PIN Password"/></p>
--	---

VI. SMS

To change the SMS service Center Address number, enter the new number in the space provided and click Update.

Language	Terminal Info	Ethernet	Telephony	PIN	SMS	Tracking	Admin	Support	Accounts	About
----------	---------------	----------	-----------	-----	------------	----------	-------	---------	----------	-------

Setup	Service Center Address
Remote Control	<input checked="" type="radio"/> SIM <input type="text" value="+870772001799"/>
	<input type="radio"/> User Defined <input type="text" value="+882161900000"/>
	<input type="button" value="Update"/>

Note: Please contact your distributor or service provider if you do not know the Service Center Address.

Remote control

Select Allow only listed numbers for secure mode, allowing only authorised mobile numbers to send commands to the BDU.

Select ACK SMS remote command to receive SMS acknowledgement from the BDU, after sending a SMS command.

Language	Terminal Info	Ethernet	Telephony	PIN	SMS	Tracking	Admin	Support	Accounts	About
----------	---------------	----------	-----------	-----	------------	----------	-------	---------	----------	-------

Setup	SMS remote control:
Remote Control	<input checked="" type="radio"/> Allow only listed numbers <input type="radio"/> Allow all
	Authorized Phone Number: <input type="text" value="+6691234567"/>
	<input type="text"/>
	<input type="text"/>
	<input type="text"/>
	ACK SMS remote command <input type="checkbox"/>
	<input type="button" value="Update"/>

SMS Command Syntax

The following SMS commands are supported (case sensitive):

SMS Command Syntax	Action
BGAN, CONNECT	To establish an IP data connection
BGAN, DISCONNECT	To terminate an IP data connection
BGAN, REBOOT	To soft-reboot the User Terminal

SMS Acknowledgment

Action	Action	Action
CONNECT	BGAN,ACK,CONNECT,OK, <Activated IP Address>	BGAN,ACK,CONNECT,ERROR
DISCONNECT	BGAN,ACK,DISCONNECT,OK	BGAN,ACK,DISCONNECT,ERROR
REBOOT	BGAN,ACK,REBOOT,OK	BGAN,ACK,REBOOT,ERROR

Example of a SMS acknowledgement on successful IP data connection:

BGAN, ACK, CONNECT, OK, "161.30.23.87"

Example of a SMS acknowledgement on unsuccessful IP data connection:

BGAN, ACK, CONNECT, ERROR

VIII. Tracking Settings

1. Select Disabled if you do not need GPS reporting.
2. Select Enabled if you need GPS reporting.
3. Select either IP Data or SMS mode.
4. Key in the desire frequency in seconds. (The time interval to update the server.)
5. Key in the server phone number (SMS mode only).
6. Key in the server IP address (IP Data mode only).
7. Key in server Port number (IP Data mode only).
8. Server Connection type is fixed to TCP (IP Data mode only).
9. Key in the Distance interval.
10. Key in the speed limit alarm.
11. Key in 3 authorized phone numbers (SMS mode only).
12. Key in number of Retries when the alert fails to send out due to unexpected error.

Language	Terminal Info	Ethernet	Telephony	PIN	SMS	Tracking	Admin	Support	Accounts	About
Settings	Geo Fence	APN (Access Point Name)	GPS Reporting:	<input type="radio"/> Enabled <input checked="" type="radio"/> Disabled						
			Mode:	IP Data ▾						
			Tracking ID:	E70Q0t						
			Frequency:	<input type="text" value="1800"/>						
			Server Phone Number:	<input type="text"/>						
			Server IP Address:	<input type="text"/>						
			Server Port:	<input type="text" value="0"/>						
			Server Connection Type:	TCP ▾						
			Distance Interval:	<input type="text" value="0"/> m						
			Speed Limit (Alarm):	<input type="text" value="0"/> km/h						
			Authorized Phone Number (1/3):	<input type="text"/>						
			Authorized Phone Number (2/3):	<input type="text"/>						
			Authorized Phone Number (3/3):	<input type="text"/>						
			Number of Retries:	<input type="text" value="2"/> (0 - 255)						
<input type="button" value="Update"/>										

Geo Fence

1. There are two ways to enter latitude/longitude:
 - a) Degrees, minutes, seconds.
 - b) Decimal degrees.
2. Select the desired latitude/longitude format.
3. Click the Add.
4. Select the alarm trigger type:
 - a) In
 - b) Out
 - c) In and Out
5. Select the type of Geo Fence:
 - a) Circle (1 points, radius)
 - b) Rectangle (2 points)
 - c) Polygon (minimum 3 points. maximum 10 points)
6. Key in the Latitude and Longitude values. Click Apply to confirm.

Language	Terminal Info	Ethernet	Telephony	PIN	SMS	Tracking	Admin	Support	Accounts	About
Settings		Latitude/Longitude view format: <input checked="" type="radio"/> dddmm.mmmm <input type="radio"/> ddd.dddddd								
Geo Fence		<input checked="" type="checkbox"/>	Out	Circle	Latitude: 112.0601 Longitude: 10332.0214 Radius: 300 m			Edit Delete Apply		
APN (Access Point Name)		<input checked="" type="checkbox"/>	In	Rectangle	Latitude1: 112.0601 Longitude1: 10332.0214 Latitude2: 123.0601 Longitude2: 10354.0214			Edit Delete Apply		
								Add Delete Apply		
								Add Delete Apply		
		<input checked="" type="checkbox"/>	In/Out	Polygon	Latitude, Longitude 100, 5000 100, 15000 5000, 7500			Edit Delete Apply		
								Add Delete Apply		
								Add Delete Apply		
								Add Delete Apply		

APN (Access Point Name)

This APN is configured to channel the tracking data traffic unlike the APN defined under DATA> Primary profile which is used for user data traffic such as Web browsing, FTP, Email etc.

By default, the SIM is selected which mean the APN stored in the Sim card will be used for the tracking function.

Follow these steps to change the Access Point Name (APN):

1. Select User Defined.
2. Enter the new APN in the field space provided (e.g. BGAN-AU.INMARSAT.COM).
3. Enter the username and password if required.

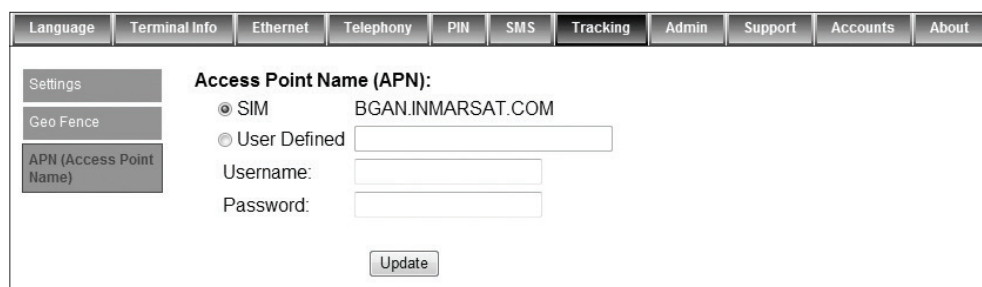

The screenshot shows a web console interface with a navigation bar at the top containing tabs for Language, Terminal Info, Ethernet, Telephony, PIN, SMS, Tracking, Admin, Support, Accounts, and About. On the left side, there is a vertical menu with options: Settings, Geo Fence, and APN (Access Point Name). The main content area is titled "Access Point Name (APN):" and contains the following elements: a radio button labeled "SIM" which is selected, followed by the text "BGAN.INMARSAT.COM"; a radio button labeled "User Defined" which is unselected, followed by an empty text input field; a label "Username:" followed by an empty text input field; a label "Password:" followed by an empty text input field; and an "Update" button at the bottom.

IX. Admin

Change Password

Follow these steps to change the Web Console login Password:

1. Enter the old password in the Old Password field.
2. Enter the new password in the New Password field.
3. Re-enter the new password in the Re-type Password field.
4. Click Update.
5. The Web Console login password is now changed.



The screenshot shows a web console interface with a navigation bar at the top containing tabs for Language, Terminal Info, Ethernet, Telephony, PIN, SMS, Tracking, Admin, Support, Accounts, and About. On the left side, there is a vertical menu with options: Change Password, Firmware Upgrade, Reboot Terminal, Factory Reset, Save Settings, GPS Output, and Ciphering. The main content area is titled "Change Password" and contains the following elements: a label "Old Password:" followed by an empty text input field; a label "New Password:" followed by an empty text input field; a label "Re-type Password:" followed by an empty text input field; and an "Update" button at the bottom.

Firmware Upgrade

Firmware upgrade is to update your FBB BDU with the latest firmware. Please refer to your respective distributor for your firmware download.

Warning: DO NOT abort the upgrading process or unplug the power of the FBB BDU during the firmware upgrade process at any time. Doing so will corrupt the existing firmware loaded onto the FBB BDU.

Follow these steps to upgrade the firmware for your FBB BDU:

1. Download or acquire the new firmware from your respective distributor and save it in your computer's hard drive.

Note: Make sure the FBB BDU is switched on and connected to the desktop/laptop computer using the LAN cable.

2. Select Firmware Upgrade.

Read the Disclaimer message carefully before proceeding with the Firmware Upgrade.

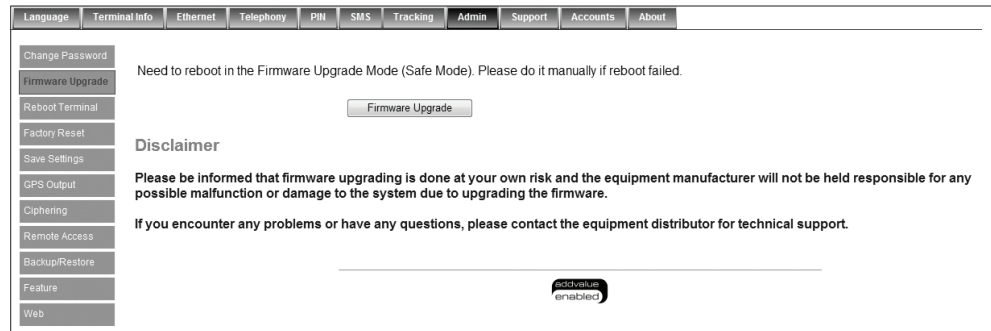

3. Click **Firmware Upgrade**.

The FBB BDU will reboot into Safe mode.

Note: All LEDs will turn to amber colour and start blinking, which means it's on Safe mode.

Waiting for Terminal to reboot into safe mode.

110

The FBB Web console will appear. Re-log in using the provided username and password.

Note: If the FBB BDU web console didn't appear, you can manually re-refresh the web console by clicking the F5 on your keyboard.



4. Browse to the location of the new firmware, select, and click Upload.
5. Firmware upgrade will take approximately 10 to 12 minutes to complete.
6. You will be prompted with the Result: Firmware Upgrade Completed message.



1. Click **Reboot Terminal** to reboot the FBB BDU.



Reboot Terminal

If you wish to reboot the FBB BDU, click Reboot Terminal. Click Reboot and wait for a few minutes to allow the TU to reboot. Refresh your browser to update the Web Console page after reboot.

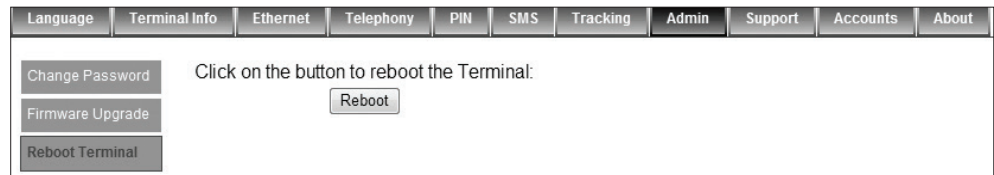

Factory Reset

To perform a Factory Reset, enter the Security code 0000 and click Factory Reset.

Warning: All the settings and user data (e.g., Phone Book, GPS, etc.) of the FBB BDU will be cleared and reset to the default settings. If you do not wish to lose critical user data such as Phone Book, please use limited reset option available via Primary Handset.

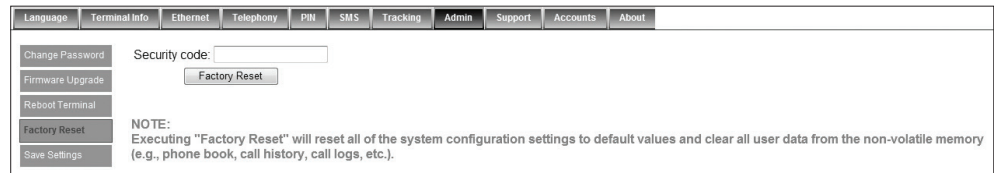

Save Settings

To power down the FBB BDU Terminal Unit using the main power switch, it is recommended to save the recent setting changes. To save the recent changes, click Save Now.



GPS Output

By default, FBB BDU Transceiver Unit outputs the GPS data in NMEA format (at 9600bps) via the NMEA 0183 Connector for GPS output. For technician who wants to diagnose the system, he/she may collect the debug log messages by selecting Output Debug Log. Since the debug mode is not required for normal users, it is recommended not to make any changes to this setting.

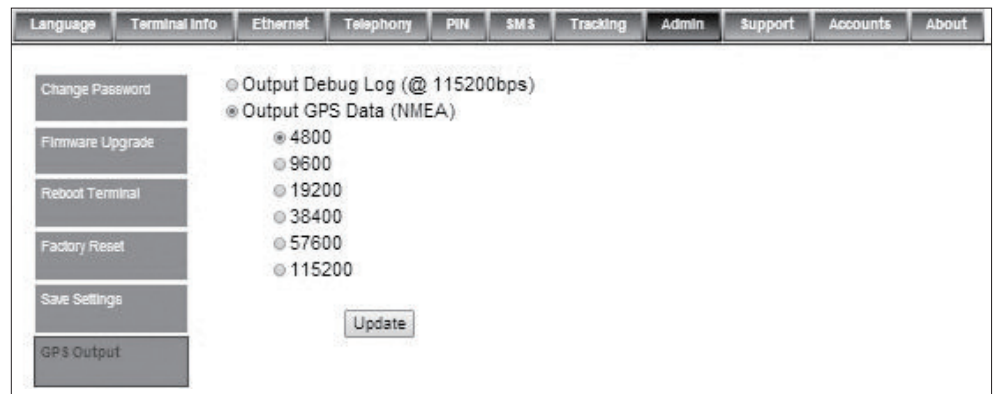
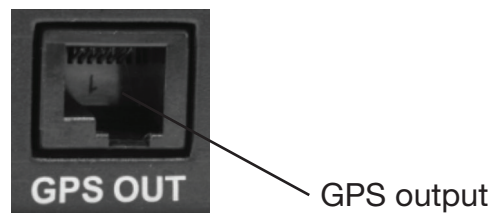

Ciphering

Enabling the Ciphering option will make the FBB BDU to exchange voice and data in secure mode by encrypting them over the air. To enable/disable the Ciphering, select the option Enabled or Disabled respectively and click Update to make the change to take effect.

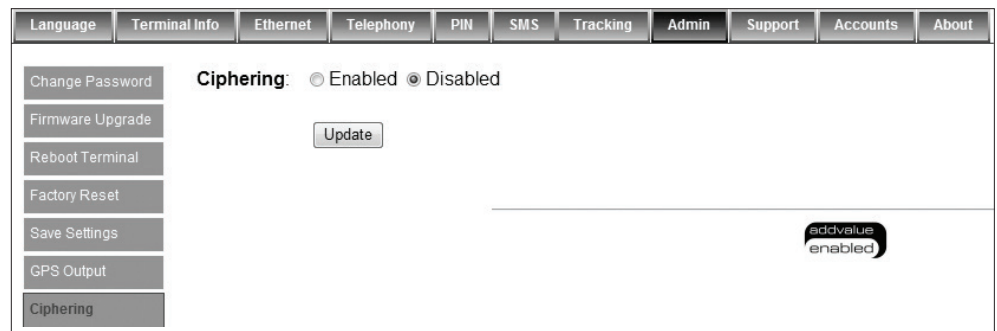

Remote access

By enabling the Remote Access option, user can remotely (from shore) access the terminal's web console via internet. In order to have a remote access, the terminal should be set in Router Mode (multi-user) and a PDP context active. If there is no active PDP context, the user can activate the PDP context by means by SMS command.

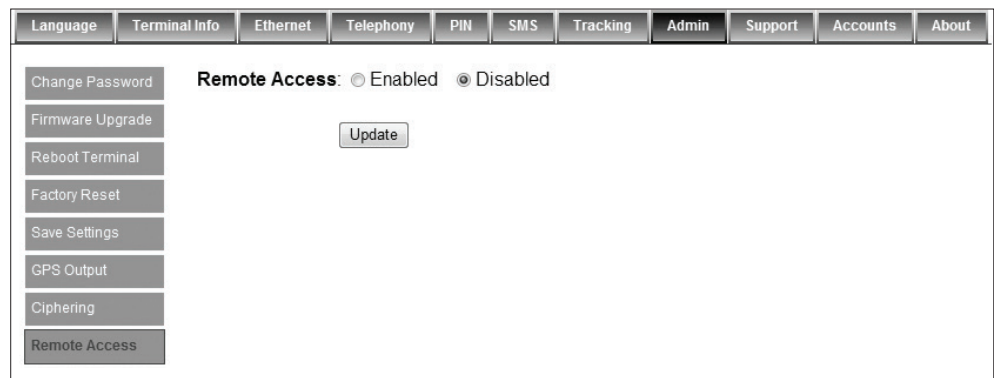

To access the web console remotely, the user has to use the public IP address of the PDP context.

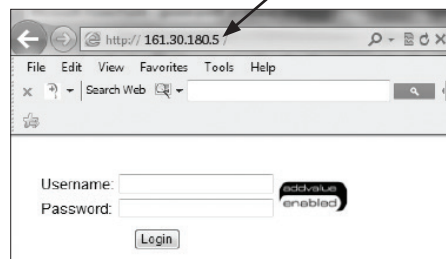
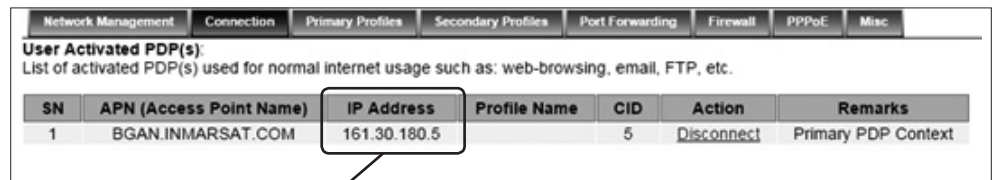

Backup/Restore

Data backup and restore refers to the copying and archiving of data so it may be used to restore the device settings after a data loss event. Partial backup option is a time saving method to replicate the same set of setting across different terminals of the same model.

It is recommended to save the backup data of the terminal in a storage media so that in the event the there is any loss of data on the UT or primary computer, the backup files will still be accessible.

Data backup/restore is easy to perform and can save the user a great amount of time during the event of attempting service recovery after data loss.

There are 2 types of backup options.

1. Full backup – This apply only on the same terminal and not for distribution.
2. Partial backup – It allows distribution of certain settings to many terminals of the same Model and Firmware version.

To restore the previous backup settings, you may click on Browse to locate the backup file and restore accordingly.

The screenshot shows a web-based configuration interface for a terminal. At the top, there is a navigation bar with tabs: Language, Terminal Info, Ethernet, Telephony, PIN, SMS, Tracking, Admin, Support, Accounts, and About. The 'Admin' tab is currently selected. On the left side, there is a vertical menu with buttons for: Change Password, Firmware Upgrade, Reboot Terminal, Factory Reset, Save Settings, GPS Output, Clphering, Remote Access, Backup/Restore (highlighted), Web, and Serial Device. The main content area is titled 'Backup:' and contains the following options:

- Full backup (can only be restore on the same Terminal)
- Partial backup (able to restore on another Terminal of the same Model)
- Selective backup
 - Port Forwarding
 - Firewall
- System Configuration

A 'Backup' button is located to the right of these options. Below the 'Backup:' section is the 'Restore:' section, which includes a 'Backup package:' label, a 'Choose File' button, and the text 'No file chosen'. A 'Restore' button is positioned below the 'Choose File' button. A large grey rectangular area is present at the bottom of the main content area, likely representing a file upload or selection interface.

Web

This tab allows user to configure the web access.

- HTTP

For remote access of web console, the user can configure the port number different from the default Port number: 80 if user wants to host a web server on the PC attached to the UT.

- HTTP Redirect

When enabled is selected, a warning message will prompt user to activate PDP connection before web browsing.

Language	Terminal Info	Ethernet	Telephony	PIN	SMS	Tracking	Admin	Support	Accounts	About
Change Password	HTTP									
Firmware Upgrade	Port: <input type="text" value="80"/> (1 ~ 65535)									
Reboot Terminal	HTTP Redirect									
Factory Reset	Status: <input type="radio"/> Enabled <input checked="" type="radio"/> Disabled									
Save Settings	<input type="button" value="Update"/>									
GPS Output										
Ciphering										
Remote Access										
Backup/Restore										
Feature										
Web										

Serial Device

Note: Port forwarding rule must be configured prior to usage of this feature.

A serial device server can transfer data between the computer serial port (COM port) and an Ethernet LAN. The serial device server is configured with a unique TCP/IP port connection on a TCP/IP network.

After establishing a connection with the serial device via the UT, data transmission can be monitored through Data Port 9001 locally (through Ethernet) or remotely (through BGAN network).

Serial Device Server Configurations

From the WebConsole, navigate to Settings > Admin > Serial Device.

TCP/IP settings

- TCP alive check time

This indicates the inactivity timeout (min) after an idling TCP connection is disconnected.

0 min: TCP connection is not closed due to an idle TCP connection.

1 to 99 min: UT automatically closes the TCP connection if there is no TCP activity for the given time. After the connection is closed, the UT starts listening for another host's TCP connection. Default is 10 min.

- TCP keep alive time

This indicates the alive time of the connection between the UT and remote PC. If the user sets the keep alive time as 1 min, every 1 min, the terminal will send an empty packet to let the remote PC know the connection is still active.

- Inactivity time

0 min: TCP connection is not closed due to an idle serial line.

1 to 99 mins: UT automatically closes the TCP connection if there is no serial data activity for the given time. After the connection is closed, the UT starts listening for another host's TCP connection. This parameter defines the maintenance status as Closed or Listen for the TCP connection.

The connection is closed if there is no incoming or outgoing data through the serial port during the specified inactivity time. Default is 0 ms.

- Max connection

Max connection is used when the user needs to receive data from different hosts simultaneously. The factory default only allows 1 connection at a time.

Max. connection 1: To open the TCP connection, UT allows only one host to the specific serial port.

Max. connection 2 to 4: UT allows 2 to 4 TCP connections of the host to open the serial port simultaneously.

- Command TCP port: 9000 (user configurable) – acts as a control port for data transmission and listen the host to prevent the conflict with other applications.

- Data TCP port: 9001 (user configurable) - acts as the TCP port that the data actually transmits through this port. After establishing the connection, data can be transmitted in both directions – from PC to port 9001 and from port 9001 to PC.

Serial settings

Users can choose the respective baud rates from 4800 to 115200.

Remote Control

Under the Remote Control section, there is the Host allow list and Host deny list in the form of IP address/mask (e.g. 10.0.0.1/24). If both lists are empty, it means that no filtering is done.

- Hosts allow list defines networks from which we accept the SIOSERV traf
- Hosts deny list defines networks from which we deny the SIOSERV traffic

Note: The deny list takes place precedence over the allow lists.

Statistics

Display the statistics of the transmitted data to the local and remote PC in bytes.

Language	Terminal Info	Ethernet	Telephony	PIN	SMS	Tracking	Admin	Support	Accounts	About
----------	---------------	----------	-----------	-----	-----	----------	-------	---------	----------	-------

Change Password	Device Serial Server <input type="radio"/> Enabled <input checked="" type="radio"/> Disabled																																				
Firmware Upgrade	TCP/IP settings																																				
Reboot Terminal	TCP alive check time: <input type="text" value="0"/> minutes																																				
Factory Reset	TCP keep alive time: <input type="text" value="0"/> minutes																																				
Save Settings	Inactivity time: <input type="text" value="0"/> minutes																																				
GPS Output	Max data connection: <input type="text" value="1"/> ▾																																				
Ciphering	Max control connection: <input type="text" value="1"/> ▾																																				
Remote Access	Command port: <input type="radio"/> Enabled <input checked="" type="radio"/> Disabled																																				
Backup/Restore	Command port authentication: <input type="radio"/> Enabled <input checked="" type="radio"/> Disabled																																				
Web	Password: <input type="text"/>																																				
Serial Device	Command TCP port: <input type="text" value="0"/>																																				
	Data TCP port: <input type="text" value="0"/>																																				
	Serial settings																																				
	Baudrate: <input type="text" value="4800"/> ▾																																				
	Remote Control																																				
	Hosts allow: <table border="1"><tr><td><input type="text"/></td><td><input type="text"/></td><td><input type="text"/></td><td><input type="text"/></td><td><input type="text"/></td><td><input type="text"/></td><td><input type="text"/></td><td><input type="text"/></td><td><input type="text"/></td><td><input type="text"/></td><td><input type="text"/></td><td><input type="text"/></td></tr><tr><td><input type="text"/></td><td><input type="text"/></td><td><input type="text"/></td><td><input type="text"/></td><td><input type="text"/></td><td><input type="text"/></td><td><input type="text"/></td><td><input type="text"/></td><td><input type="text"/></td><td><input type="text"/></td><td><input type="text"/></td><td><input type="text"/></td></tr><tr><td><input type="text"/></td><td><input type="text"/></td><td><input type="text"/></td><td><input type="text"/></td><td><input type="text"/></td><td><input type="text"/></td><td><input type="text"/></td><td><input type="text"/></td><td><input type="text"/></td><td><input type="text"/></td><td><input type="text"/></td><td><input type="text"/></td></tr></table>	<input type="text"/>	<input type="text"/>	<input type="text"/>	<input type="text"/>	<input type="text"/>	<input type="text"/>	<input type="text"/>	<input type="text"/>	<input type="text"/>	<input type="text"/>	<input type="text"/>	<input type="text"/>	<input type="text"/>	<input type="text"/>	<input type="text"/>	<input type="text"/>	<input type="text"/>	<input type="text"/>	<input type="text"/>	<input type="text"/>	<input type="text"/>	<input type="text"/>	<input type="text"/>	<input type="text"/>	<input type="text"/>	<input type="text"/>	<input type="text"/>	<input type="text"/>	<input type="text"/>	<input type="text"/>	<input type="text"/>	<input type="text"/>	<input type="text"/>	<input type="text"/>	<input type="text"/>	<input type="text"/>
<input type="text"/>	<input type="text"/>	<input type="text"/>	<input type="text"/>	<input type="text"/>	<input type="text"/>	<input type="text"/>	<input type="text"/>	<input type="text"/>	<input type="text"/>	<input type="text"/>	<input type="text"/>																										
<input type="text"/>	<input type="text"/>	<input type="text"/>	<input type="text"/>	<input type="text"/>	<input type="text"/>	<input type="text"/>	<input type="text"/>	<input type="text"/>	<input type="text"/>	<input type="text"/>	<input type="text"/>																										
<input type="text"/>	<input type="text"/>	<input type="text"/>	<input type="text"/>	<input type="text"/>	<input type="text"/>	<input type="text"/>	<input type="text"/>	<input type="text"/>	<input type="text"/>	<input type="text"/>	<input type="text"/>																										
	Hosts deny: <table border="1"><tr><td><input type="text"/></td><td><input type="text"/></td><td><input type="text"/></td><td><input type="text"/></td><td><input type="text"/></td><td><input type="text"/></td><td><input type="text"/></td><td><input type="text"/></td><td><input type="text"/></td><td><input type="text"/></td><td><input type="text"/></td><td><input type="text"/></td></tr><tr><td><input type="text"/></td><td><input type="text"/></td><td><input type="text"/></td><td><input type="text"/></td><td><input type="text"/></td><td><input type="text"/></td><td><input type="text"/></td><td><input type="text"/></td><td><input type="text"/></td><td><input type="text"/></td><td><input type="text"/></td><td><input type="text"/></td></tr><tr><td><input type="text"/></td><td><input type="text"/></td><td><input type="text"/></td><td><input type="text"/></td><td><input type="text"/></td><td><input type="text"/></td><td><input type="text"/></td><td><input type="text"/></td><td><input type="text"/></td><td><input type="text"/></td><td><input type="text"/></td><td><input type="text"/></td></tr></table>	<input type="text"/>	<input type="text"/>	<input type="text"/>	<input type="text"/>	<input type="text"/>	<input type="text"/>	<input type="text"/>	<input type="text"/>	<input type="text"/>	<input type="text"/>	<input type="text"/>	<input type="text"/>	<input type="text"/>	<input type="text"/>	<input type="text"/>	<input type="text"/>	<input type="text"/>	<input type="text"/>	<input type="text"/>	<input type="text"/>	<input type="text"/>	<input type="text"/>	<input type="text"/>	<input type="text"/>	<input type="text"/>	<input type="text"/>	<input type="text"/>	<input type="text"/>	<input type="text"/>	<input type="text"/>	<input type="text"/>	<input type="text"/>	<input type="text"/>	<input type="text"/>	<input type="text"/>	<input type="text"/>
<input type="text"/>	<input type="text"/>	<input type="text"/>	<input type="text"/>	<input type="text"/>	<input type="text"/>	<input type="text"/>	<input type="text"/>	<input type="text"/>	<input type="text"/>	<input type="text"/>	<input type="text"/>																										
<input type="text"/>	<input type="text"/>	<input type="text"/>	<input type="text"/>	<input type="text"/>	<input type="text"/>	<input type="text"/>	<input type="text"/>	<input type="text"/>	<input type="text"/>	<input type="text"/>	<input type="text"/>																										
<input type="text"/>	<input type="text"/>	<input type="text"/>	<input type="text"/>	<input type="text"/>	<input type="text"/>	<input type="text"/>	<input type="text"/>	<input type="text"/>	<input type="text"/>	<input type="text"/>	<input type="text"/>																										
	Note: The deny list takes precedence over the allow lists.																																				
	<input type="button" value="Update"/>																																				
	Statistics																																				
	<table border="1"><thead><tr><th>IP Address</th><th>Local</th><th>Remote</th></tr></thead><tbody><tr><td>1.2.3.4</td><td>0</td><td>0</td></tr><tr><td>2.3.4.5</td><td>0</td><td>0</td></tr><tr><td>3.2.3.4</td><td>0</td><td>0</td></tr><tr><td>4.2.3.4</td><td>0</td><td>0</td></tr></tbody></table>	IP Address	Local	Remote	1.2.3.4	0	0	2.3.4.5	0	0	3.2.3.4	0	0	4.2.3.4	0	0																					
IP Address	Local	Remote																																			
1.2.3.4	0	0																																			
2.3.4.5	0	0																																			
3.2.3.4	0	0																																			
4.2.3.4	0	0																																			

X. Support

Display information of the support telephone number, support email address, Support URL and Services URL. (The information shown is for sample purpose only.)

Language	Terminal Info	Ethernet	Telephony	PIN	SMS	Tracking	Admin	Support	Accounts	About
Inmarsat Distribution Partner Name:		ALPHA TEST DATA								
Phone Number For Support:		+442077281653								
Support E-Mail Address:		BGANTEST1@INMARSAT.COM								
Support URL:		http://SUPPORT.INMARSAT.COM/MMI1.ASPX								
Services URL:		http://SUPPORT.INMARSAT.COM/MMI2.ASPX								

XI. Accounts

Select Add to add new user.

1. Select **Delete** to delete specific user.
2. Select **Change Password** to change specific user's password.

Language	Terminal Info	Ethernet	Telephony	PIN	SMS	Tracking	Admin	Support	Accounts	About
Accounts		Users: /10								
								<input type="button" value="Add"/>		
								<input type="button" value="Delete"/>		
								<input type="button" value="Change Password"/>		

9 TROUBLESHOOTING

General LED status

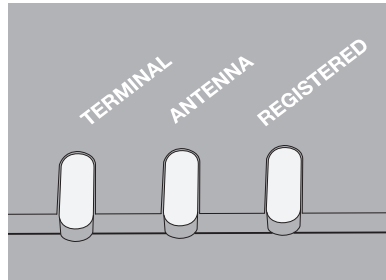

BDU LED

LED behavior	Descriptions / Remedial Actions
Off	BDU is in power-off state.
Steady amber	BDU is powering up.
Steady green	BDU successfully powered up.
Steady red	System failure during boot up or operation. User action required.

Antenna LED

LED behavior	Descriptions / Remedial Actions
Off	ADU status is unknown.
Steady amber	ADU is powering up.
Blinking amber	ADU is calibrating.
Blinking green	System is searching for satellite.
Steady green	System is locked onto a satellite and ready for use.
Steady red	System failure in ADU. User action required.

Network Registered LED

LED behavior	Descriptions / Remedial Actions
Off	System is not registered to the network. Network service is unknown.
Blinking green	Ready for packet data only.
Steady green	Network registration succeeded. Full network service available.
Blinking amber	Ready for voice only.
Steady red	System failure in network registration. User action required.

SIM Card

Symptoms	Descriptions / Remedial Actions
SIM Card cannot be detected BDU	<ul style="list-style-type: none"> • Ensure that a correct Inmarsat SIM card is used. • Ensure that a SIM card is properly inserted into SIM Card slot. • Retry by re-inserting the SIM card into SIM Card Slot before powering up the BDU.
BDU indicates “Wrong SIM Card”	<ul style="list-style-type: none"> • Ensure that a correct SIM card is used.

GPS Output

Symptoms	Descriptions / Remedial Actions
Unable to acquire GPS even after a long time	<ul style="list-style-type: none"> • Ensure that there is no blockage for the antenna. • Ensure that the antenna cable is secured properly.
No NMEA string output from the GPS output port	<ul style="list-style-type: none"> • Ensure that there is a proper connection at the GPS output port. • Ensure that the GPS output is set to Output NMEA data via the Web Console.

PoE LAN Port (RJ45)

Symptoms	Descriptions / Remedial Actions
No LAN indication	<ul style="list-style-type: none"> • Ensure that the Ethernet Cable is plugged into the PoE LAN port (RJ45) or the standard LAN port (RJ45) correctly. • Check to ensure that the Ethernet Port on your PC / Laptop is working fine.
Unable to acquire IP address. PC shows “Limited connectivity”	<ul style="list-style-type: none"> • Try to unplug and reconnect the Ethernet Cable. • Try to reboot the BDU. • Try to restart your PC/Laptop.
Unable to ping my BDU	<ul style="list-style-type: none"> • Ensure that the LAN indication LED is active. • Ensure that the IP address of the BDU is set correctly. • Make sure that there is no firewall or proxy settings in your PC/laptop that prevent access to the BDU.

RJ11 Phone Port for Standard Call

Symptoms	Descriptions / Remedial Actions
Unable to make outgoing call	<ul style="list-style-type: none"> • Make sure that there is dial tone before making the call. For the case of busy tone, <ul style="list-style-type: none"> ◦ Ensure that the line is not engaged by any other telephone services. ◦ Ensure that all other telephony devices are hung up properly. • For the case of no dial tone, <ul style="list-style-type: none"> ◦ Ensure that the phone line is connected to the phone port of the BDU. • Hang up and retry the call again.
Unable to receive incoming call	<ul style="list-style-type: none"> • Ensure that the line is not engaged by any other telephony devices. • Ensure that all other telephony devices are hung up properly. • Ensure proper BDU LED states. • Ensure the phone ports are configured correctly.
Distorted audio during outgoing/incoming call	<ul style="list-style-type: none"> • The audio may clip when use with some phones in high volume. Please lower the volume of the phone in such situation. • Please temporarily disconnect any data connection since high throughput may affect the quality of the audio. • Hang up and retry the call again.

Primary Handset

Symptoms	Descriptions / Remedial Actions
No display/power for Primary handset	<ul style="list-style-type: none"> • Check the DC power supply input to the BDU. • Check the primary handset is properly inserted to the handset port.
Unable to connect to the BDU	<ul style="list-style-type: none"> • Ensure the primary handset is inserted to the handset port.
Unable to make outgoing call	<ul style="list-style-type: none"> • Ensure a correct number format is being dialed. • Ensure proper BDU LED states. • Hang up and retry to make the call.
Unable to receive incoming call	<ul style="list-style-type: none"> • Ensure that the line is not engaged by any other telephony devices. • Ensure that all other telephony devices are hung up properly. • Ensure proper BDU LED states. • Ensure the phone ports are configured correctly.
No audio during incoming/outgoing call	<ul style="list-style-type: none"> • Ensure the Primary Handset connector is inserted into the handset port properly. • Hang up and retry the call again. • Try to reboot the BDU.
Distorted audio during incoming/outgoing call	<ul style="list-style-type: none"> • Lower the volume of the Primary Handset. • Please temporarily disconnect any background data connection since high throughput may affect the quality of the audio. • Hang up and retry the call.

web Console

Symptoms	Descriptions / Remedial Actions
Unable to access Web Console	<ul style="list-style-type: none"> • Ensure that there is no problem with the Ethernet connectivity. • Ensure that IP address is entered correctly. • Try to refresh the browser after correcting the problem.
Unable to login	<ul style="list-style-type: none"> • Ensure that correct username and password are used (Password and username are case sensitive). • Ensure that you do not open more than the maximum Web Console sessions allowed. • Retry by closing and reopening the web browser.
Web page does not seem to be updated or there are unexpected errors occurred.	<ul style="list-style-type: none"> • Refresh the web page. • Update the web browser to the latest version and retry.

Data Connection

Symptoms	Descriptions / Remedial Actions
Unable to active Primary PDP context	<ul style="list-style-type: none"> • Ensure you are using a valid APN. • Ensure that the signal strength is good. • Ensure that the PS status icon is highlighted. • Ensure your SIM card supports PS services. • Ensure your prepaid credit is not exhausted
Unable to access internet after successfully Primary PDP context activation	<ul style="list-style-type: none"> • Ensure proper PC/laptop Ethernet settings. • Ensure no firewall/proxy settings are preventing access to the BDU. • Ensure that the PC/laptop is configured to obtain IP address automatically (DHCP) or with static IP address in the range: 192.168.0.1 - 192.168.254.254
“Always On” feature is not working	<ul style="list-style-type: none"> • Ensure feature is enabled via Web Console. • A standard background connection has to be manually activated for the first time after enabling this feature.

Data Connection

Symptoms	Descriptions / Remedial Actions
Unable to enter safe mode. BDU continues to start in normal mode.	<ul style="list-style-type: none"> • Make sure that the safe mode button (the button besides the SIM card slot) is pressed and held securely until all LEDs turn into amber colour.
Firmware upgrade fails	<ul style="list-style-type: none"> • Make sure that you are using the correct firmware upgrade package. • Make sure that there is no interruption of power supply during firmware upgrade. • Retry firmware upgrade.

Antenna / Satellite Signal Level

Symptoms	Descriptions / Remedial Actions
Low Signal Strength	<ul style="list-style-type: none">• Check any obstruction such as the hull or monkey bridge of the vessel that may block the ADU's line of sight.• Check any interference signal from other electronics devices that are close to the ADU• Check to ensure that the antenna cable is properly secured.• Depending on the antenna's location on the vessel, the vessel's route may cause the ADU's line of sight to be blocked by any structure of the vessel, depending on the elevation of the satellite.

System fails to power up

Symptoms	Descriptions / Remedial Actions
No light appear on BDU LED.	<ul style="list-style-type: none">• Ensure the power switch on the front panel is at "On" position.• To reset the circuit breaker on the front panel by depressing the lever of the circuit breaker inward fully and release.• Check to ensure that the input DC power will have at least +24VDC, 10A or +12VDC, 20A.

Technical Specification

Model	Specifications
Intellian FB150	Fleetbroadband Terminal
Dimension and Weight	
ADU	Standard: 29.9cm x 27.7cm (11.8" x 10.9") / 3.0kg (6.6 lbs) FB150 Intellian i2 Matching Dome: 14.7 x 15 in (37 x 38.1cm) / 7.27 lbs (3.3kg) FB150 Intellian i3 Matching Dome: 16.9 x 17.3 in (43 x 44cm) / 10.58 lbs (4.8kg) FB150 Intellian i4 Matching Dome: 19.7 x 21.2 in (50 x 54cm) / 11.02 lbs (5kg)
BDU	14.1 x 9.8 x 2.6 in (36 x 25 x 6.7 cm) / 8.5 lbs (3.9 kg)
Handset	5.5 x 2.2 x 0.8 in (14.2 x 5.6 x 2.2 cm) / 0.8 lbs (0.39 kg)
Environmental Conditions	
Operating Temperature	-25°C ~ +55°C / -13°F ~ +131°F
Operating Humidity	[ADU]EN60945,[BDU]95%non-condensingat+40° C
Water Ingress	[ADU] IP56, [BDU] IP31
Approvals	Inmarsat FleetBroadband / R&TTE / CE / FCC
Warranty	3 Years Parts and 1 Year Labor
Global Services	
Voice	Digital 4 kbps Voice
Standard IP	Up to 150 kbps
SMS	Up to 160 characters (3G standard)
FAX	Group 3 (via 3.1KHz Audio)
Airtime Service	Inmarsat airtime
Frequency Band	
Rx	1518.0 MHz – 1559.0 MHz
Tx	1626.5 MHz – 1675.0 MHz
Ch. Width	[Rx] 10.5 - 189 kHz, [Tx] 21 - 189 kHz
Power Supply and Consumption	
DC Input Range	10 - 32V DC (isolated)
Power (max)	150W @ 10-32V (including antenna)

Warranty

This product is warranted by Intellian Technologies Inc., to be free from defects in materials and workmanship for a period of THREE (3) YEARS on parts and TWO (2) YEARS on labor performed at Intellian Technologies, Inc. service center from the purchased date of the product.

Intellian Technologies, Inc. warranty does not apply to product that has been damaged and subjected to accident, abuse, misuse, non-authorized modification, incorrect and/ or non-authorized service, or to a product on which the serial number has been altered, mutilated or removed.

It is required to present a copy of the purchase receipt issued by Intellian Technologies, Inc. that indicates the date of purchase for after-sales service under the warranty period. In case of failure to present the purchase receipt, the warranty period will begin 30 days after the manufacturing production date of the product purchased.

Any product which is proven to be defective in materials or workmanship, Intellian Technologies, Inc. will (at its sole option) repair or replace during the warranty period in accordance with this warranty. All products returned to Intellian Technologies, Inc. under the warranty period must be accompanied by a return material authorization (RMA) number issued by the dealer/distributor from Intellian Technologies, Inc. and a copy of the purchase receipt as a proof of purchased date, prior to shipment. Alternatively, you may bring the product to an authorized Intellian Technologies, Inc. dealer/distributor for repair.

Additional Terms and Conditions:

The warranty(THREE (3) YEARS on parts and TWO (2) YEARS on labor) is effective only for products purchased since January 1st, 2017.