

Intellian[®]

s100HD WorldView[™] **Installation and Operation User Guide**

Serial number of the product

This serial number will be required for all troubleshooting or service inquiries.

Intellian[®]

© 2017 Intellian Technologies Inc. All rights reserved.

Intellian and the Intellian logo are trademarks of Intellian Technologies, Inc., registered in the U.S. and other countries. s100HD WorldView and WorldView Trio LNB are trademarks of Intellian Technologies, Inc. Intellian may have patents, patent applications, trademarks, copyrights, or other intellectual property rights covering subject matter in this document. Except as expressly provided in any written license agreement from Intellian, the furnishing of this document does not give you any license to these patents, trademarks, copyrights, or other intellectual property. All other logos, trademarks, and registered trademarks are the property of their respective owners. Information in this document is subject to change without notice. Every effort has been made to ensure that the information in this manual is accurate. Intellian is not responsible for printing or clerical errors.

CE & FCC Declaration of Conformity (DoC)

We, Intellian Technologies, Inc. located at 18-7, Jinwisandan-ro, Jinwi-myeon (Chungho-ri), Pyeongtaek-si, Gyeonggi-do 17709 Korea declare under our sole responsibility that the product(s) described in the below to which this declaration relates is in conformity with the requirements of the *EU EMC Directive 89/336/EEC and FCC 47 CFR Part 15 Subpart B when the methods, as described in EN 60945: 2002 and ANSI C63.4: 2014, respectively.*

Product Information:

Product Name(s):	Intellian s100HD, 109cm Dual band Maritime TVRO Antenna System
Model Number(s):	T3-107AT3

Supplementary Information:

Notified Body Involved: (Testing Organization)	DT&C Co., Ltd. 42, Yurim-ro, 154beon-gil, Cheoin-gu, Yongin-si, Gyeonggi-do, 17042 Korea
Technical/Compliance File Held by:	Intellian Technologies, Inc. 18-7, Jinwisandan-ro, Jinwi-myeon (Chungho-ri), Pyeongtaek-si, Gyeonggi-do 17709 Korea

Authority: Steve Cha
/ CTO, R&D

Signature:  _____

Date: February 14, 2017

INDEX

INTRODUCTION	9
Intellian s100HD WorldView™ Introduction	10
Intellian s100HD WorldView™ Features	11
Basic System Configuration	13
Tools Required for Installation	15
INSTALLING THE ANTENNA	17
System Package	18
Planning the Installation	22
Antenna Installation	31
INSTALLING THE ACU	41
Mounting the ACU/MSM	42
Connecting Cables to the ACU	44
ACU Connector Guide	46
Connecting the ACU and MSM	47
Connecting the MSM and Receiver(s)	48
PC to ACU Communication Setup	49
Wi-Fi Connection	52
OPERATING THE ACU	55
Introduction	56
Normal Mode	58
Setup Mode	63
Installation Settings	64
Antenna Settings	68
Satellite Settings	84
System Settings	94
Aptus®	101
Introduction	102
Software Installation	103
PC to ACU Communication Setup	104
Toolbar Menus	107
System Property Status Dashboard	110
Work View Tabs	113
Aptus WEB	127
Introduction	128
Main Page	129
Antenna Settings	133
Firmware & Configuration	140
Administration	146
TECHNICAL SPECIFICATION	155
WARRANTY	157

INTRODUCTION

Intellian s100HD WorldView™ Introduction

Intellian s100HD WorldView™ Features

Basic System Configuration

Tools Required for Installation

Intellian s100HD WorldView™ Introduction

Intellian s100HD WorldView is a digital marine satellite antenna system specifically designed for reception of worldwide Ku-band satellites as well as the DIRECTV® services enabling seamless and uninterrupted satellite TV reception across multiple coverage areas and service providers.

The dual-band 3-axis marine satellite antenna system is capable of receiving two Ka-band satellite signals and one Ku-band signal for DIRECTV® North American programming, enabling all channels to be watched simultaneously. Additionally, the antenna incorporates Intellian's first dual-band LNB combined with WorldView capability. The Intellian Ku- and Ka-band WorldView Trio LNB™ with triple feed horn enables HD and SD TV to be watched anywhere in the world. The user simply selects a satellite television provider and connects to a satellite receiver, allowing the WorldView™ Trio LNB to automatically switch frequency depending on the region the antenna is operating in.

The Intellian Multi-Switch module with the built-in SWM (Single Wire Multi-switch) and standard-type Multi-switch outputs provides simple connection to different satellite receivers enabling TV viewing on multiple TV screens. The s100HD WorldView antenna provides total solutions for uninterrupted satellite receptions without requiring complex installation and re-configuration of systems.

The s100HD WorldView features Intellian's patented WRS (Wide Range Search) algorithm for fast signal acquisition. Designed to excel in all sea states and weather conditions, the s100HD is tested to industry-leading standards for vibration and resonance frequency, as well as extreme shock.

Intellian s100HD WorldView™ Features

Simultaneous reception of DIRECTV® Ka- and Ku-Band

The antenna solutions incorporate 3 feed horns to simultaneously receive 3 satellites; 2 DIRECTV® 99° and 103° Ka-Band satellites and 1 DIRECTV® 101° Ku-band satellite. This allows viewers of satellite programs to watch every DIRECTV® channel without changing satellites.

Global coverage of Ku-band satellites

Intellian's WorldView LNB technology enables reception of all Ku-Band satellites around the globe. The World View LNB module is programmed to select each satellite's L.O. automatically, which allows mariners to enjoy any satellite TV services by simply selecting a target satellite and connecting a set top box. This is because the World View LNB module can automatically switch to the corresponding polarization and local frequency regardless of the linear or circular polarization.

Multi Switch Module

The Intellian Multi-Switch module is included in the system and provides simple connection to different types of satellite receivers. The built-in SWM outputs and standard multi-switch outputs support both Single Wire and standard installations, reducing the need for additional hardware and reconfiguration of the system when viewing programs on multiple TV screens.

DVB-S2 signal identification

Intellian s100HD WorldView is fully compatible with DVB-S2 signals. It detects, identifies, and tracks satellite transmitting the DVB-S2 signal format. A compatible satellite TV receiver and subscription is required.

Global Satellite Library

The pre-programmed Global Satellite Library allows the user to select the desired TV satellite service while traveling from region to region. Once the satellite is selected the WorldView™ Trio LNB module will automatically switch to the corresponding local frequency to receive the signal.

Outstanding reliability

Intellian s100HD provides highly reliable system through the implementation of a modularized design, use of strictly proven components, and Intellian's rigorous environmental test standards.

Dedicated Management Ethernet Port

The management Ethernet Port on the front of the ACU enables direct and simple network connection between a PC and the ACU. The Management Port supports DHCP network connection by default, allowing automatic IP configurations and quick access to Intellian's remote management solution.

19 inch rack-mount type ACU (Antenna Control Unit)

Intellian s100HD's ACU offers pre-programmed global satellites library and its specially designed PC controller software allows free lifetime system upgrades.

Wireless Connectivity

The built-in Wi-Fi enables the ACU to be wirelessly connected and can be either turned on or off by a switch. Any kind of wireless devices such as PCs, laptops and smartphones can be used to connect to the ACU and monitor, control and change the settings of the system wirelessly.

Intellian Network Devices

Intellian Aptus Web enables connection to the s100HD to monitor the real time status of the connected system. This function provides users with a direct connection to network devices allowing an integrated control solution for linking multiple devices.

Basic System Configuration

For the satellite TV system to work correctly, the system will have to be connected with all the provided components, as shown in the figure below. Satellite receivers (IRD's) and provider subscriptions are purchased separately.

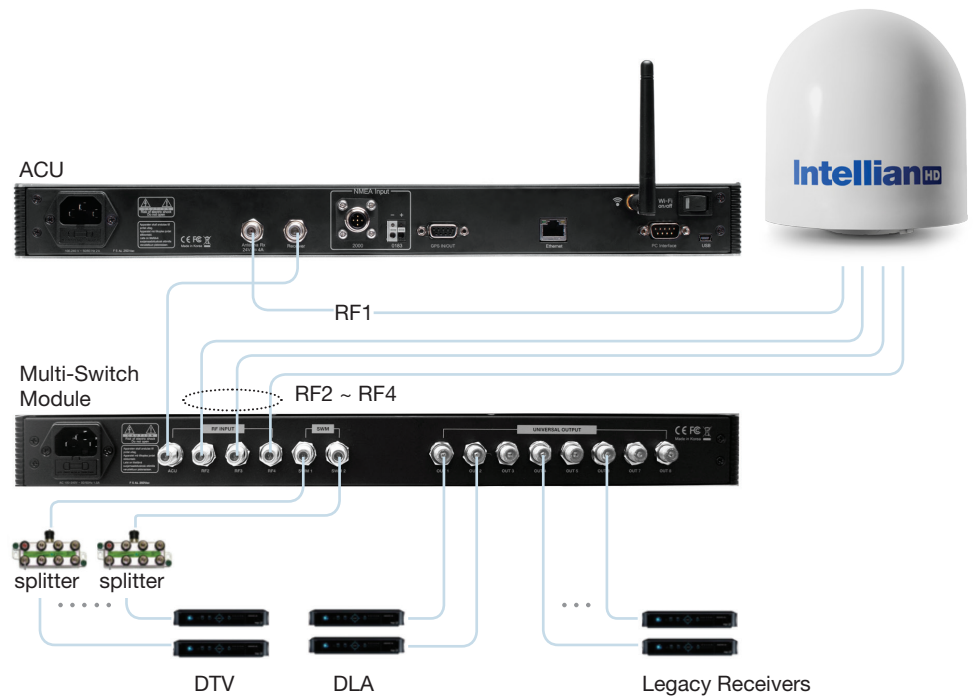

Basic Steps for system setup and connection.

1. Connect the RF cable from the RF1 connector on the power switch box located inside the radome to the ANT. Rx connector on the ACU.
2. Connect the RF cable from the RECEIVER connector on the ACU to the ACU connector on the Multi-switch module.
3. Connect the RF cable from the RF2 connector on the power switch box to the RF2 connector on the Multi-switch module.
4. Connect the RF cable from the RF3 connector on the power switch box to the RF3 connector on the Multi-switch module.
5. Connect the RF cable from the RF4 connector on the power switch box to the RF4 connector on the Multi-switch module.
6. To connect SWM compatible receivers, connect an RF cable from the SWM connector on the Multi-switch module to a SWM receiver. Up to 16 DTV receivers can be connected using the provided splitters as shown in the diagram.
7. To connect other non-SWM compatible receivers, connect RF cable(s) from the UNIVERSAL OUTPUT (1~ 8) to desired standard receiver(s).
8. Connect the gyrocompass to the NMEA Input on the ACU.
9. Connect the power cable from the AC power connector on the ACU to a power source at 100- 240 V AC.
10. Press the power switch on the ACU to start the operation of the antenna system.

Tools Required for Installation

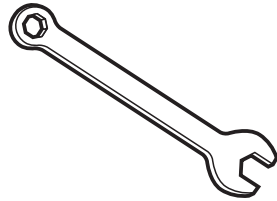

11 mm Spanner

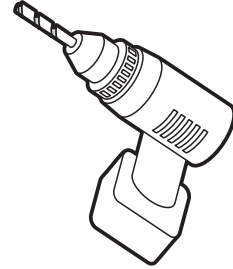

Power Drill

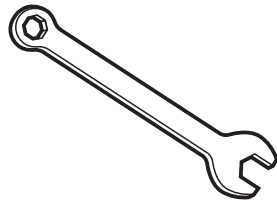

13 mm Spanner

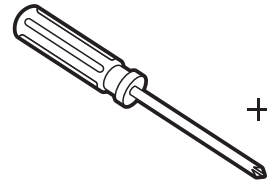

Cross Head Screwdriver

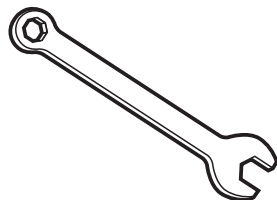

19 mm Spanner

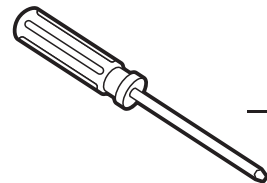

Flat Head Screwdriver

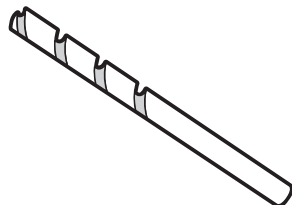

13 mm Drill Bit

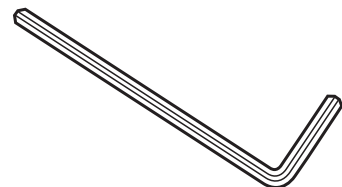

5 mm Allen/Hex key

INSTALLING THE ANTENNA

System Package

Antenna Unit

Antenna Control Unit (ACU)

Multi-Switch Module (MSM)

Installation Kit

Planning the Installation

Selection of Antenna Installation Site

Minimize Satellite Blockage

Avoid RF Interference

Antenna Dimensions

Antenna Mounting Templates

Mast Making Guide

Position the Radome

Placing cables on the Mast

System Cables

RF Cables (Customer Supplied)

Gyrocompass (Customer supplied)

Antenna Installation

Unpacking the wooden crate

Placing the antenna on a mast

Mounting the Radome

Remove the Shipping Brackets

Connecting RF Cables

System Package

The Intellian s100HD WorldView™ consists of four major units, an antenna unit, antenna control unit, multi-switch module, and installation kit box.

Antenna Unit

The antenna unit includes an antenna pedestal inside a radome assembly unit. The pedestal consists of the satellite antenna main dish and sub-reflector module with a WorldView™ Trio LNB module mounted on a stabilized pedestal. The radome protects the antenna pedestal assembly unit from the severe marine environment.



Antenna Control Unit (ACU)

The Antenna Control Unit (ACU) provides power to the antenna and controls various settings of the antenna. Additionally, the VFD (Vacuum Fluorescent Display) allows for operation of the ACU in the dark.



Front



Rear

Multi-Switch Module (MSM)

The Intellian Multi-Switch Module provides built-in SWM and standard multi-switch outputs allowing configuration with DIRECTV satellite receivers and standard satellite receivers.



Front



Rear

Installation Kit

Contains the items required for installing the antenna unit, ACU, and MSM on the vessel.

ACU box			
Description	Q'ty	Size	Remarks
Antenna Control Unit (ACU)	1	431mm x 381mm x 44mm	Antenna Control Unit
Multi-switch Module box			
Description	Q'ty	Size	Remarks
Multi-switch Module (MSM)	1	431mm x 381mm x 44mm	Multi-switch Module
Components box			
Description	Q'ty	Size	Remarks
ACU Bracket (Rack)	2		ACU-19inch Rack
ACU Bracket (Table)	2		ACU-Table
MSM Bracket (Rack)	2		MSM-19inch Rack
MSM Bracket (Table)	2		MSM-Table
8-way splitter for SWM	2		SWM(on MSM) to DIRECTV receivers
RG6 Cable	2	3m	ACU to MSM MSM to Receiver
AC Power Cord (CEEE7/7)	2	1.5m	ACU Power MSM Power
PC Serial Cable	1	1.8m	ACU to PC
USB Cable (A-A)	1	1.8m	ACU to PC
Maintenance Wire	1		Radome hatch (chain: 6EA)
Hex Socket Head Cap	5	M6 x 40L	Radome (Top-to-Bottom)
Dome Washer (Flat Washer & Spring Washer)	5	M6	Radome (Top-to-Bottom)
Hex Bolt	5	M12 x 100L	
Flat Washer	5	M12	Antenna-Deck
Spring Washer	5	M12	
Hex Nut	10	M12	
Self-Tapping Screw	5	ø4 x 16	ACU-Table Mount Bracket
Flat Head Screw	10	M4 x 12L	ACU-Rack Mount Bracket
Sems Bolt	5	M3 x 12L	ACU-Table Mount Bracket
Self-Tapping Screw	5	ø4 x 16	MSM-Table Mount Bracket
Flat Head Screw	10	M4 x 12L	MSM-Rack Mount Bracket
Sems Bolt	5	M3 x 12L	MSM-Table Mount Bracket
User Manual	1		
Mounting Template	1		
Wi-Fi Antenna	1		
USB Flash Drive (4G)	1		Antenna Software and User Manual file
Cable Tie	10		

Planning the Installation

Selection of Antenna Installation Site

The mounting platform should be robust enough and not subject to vibration. The movement of the antenna can be minimized by installing at the center of the vessel. If these conditions can be only partially satisfied, find the best compromised installation site.

Minimize Satellite Blockage

Install the antenna in accordance with the following procedures to ensure maximum performance of the antenna. The ideal antenna site should have a clear view of the horizon or satellite with all around clearance. Please be sure there are no obstacles within the EL range -20° to $+115^{\circ}$ from the center of the antenna. Obstacles can prevent the antenna from transmitting and receiving the satellite signal.

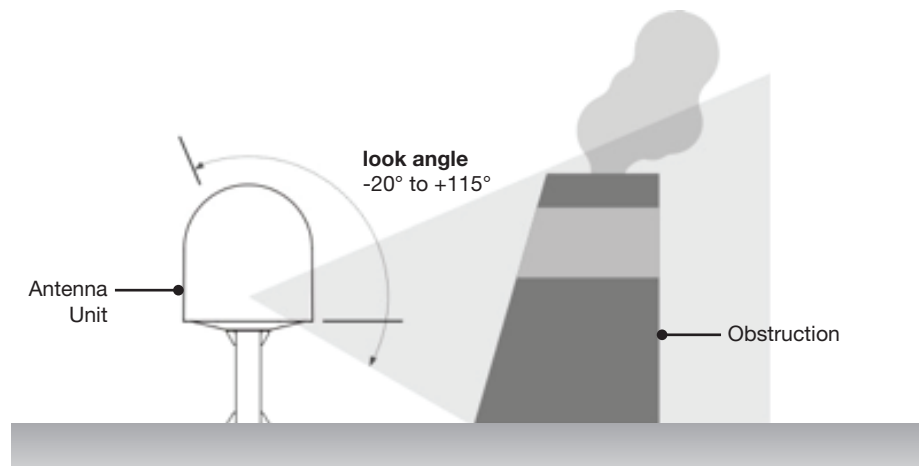

Avoid RF Interference

Do not install the antenna near the high power short wave radar.
 Most radar transmitters emit RF energy within an elevation range of -15° to $+15^{\circ}$.
 For this reason, It is recommended to position the antenna at least 15 feet (4.6 m)
 away from the radar.

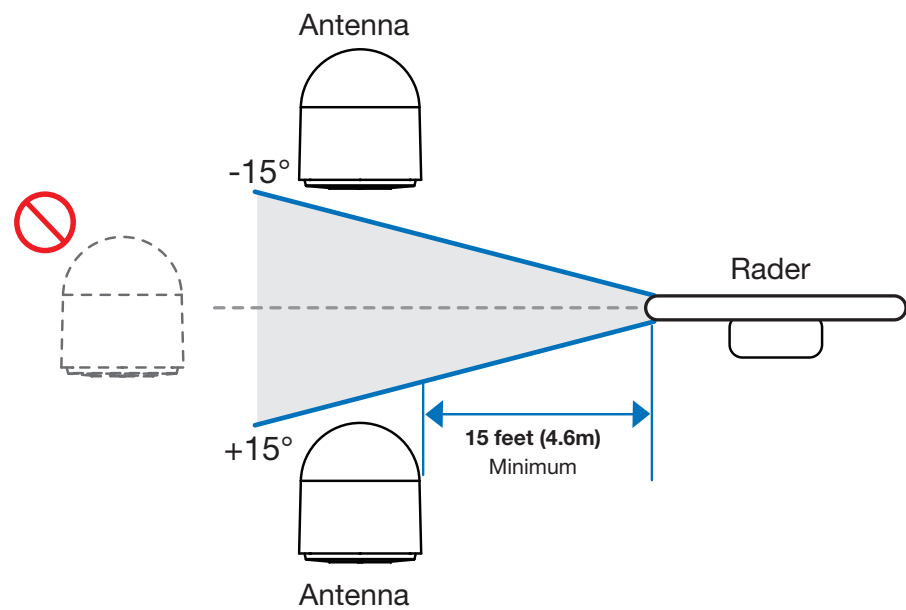

WARNING:
 Never place the antenna in the beam path of the radar regardless of distance. The high power short wave radar may impair its performance or damage the antenna.

Antenna Dimensions

The method of installation and mounting of the antenna may vary with vessel design, but the following procedures are applicable in most situations, resulting in a secure and effective installation. Confirm the height and diameter of the antenna before installing it.

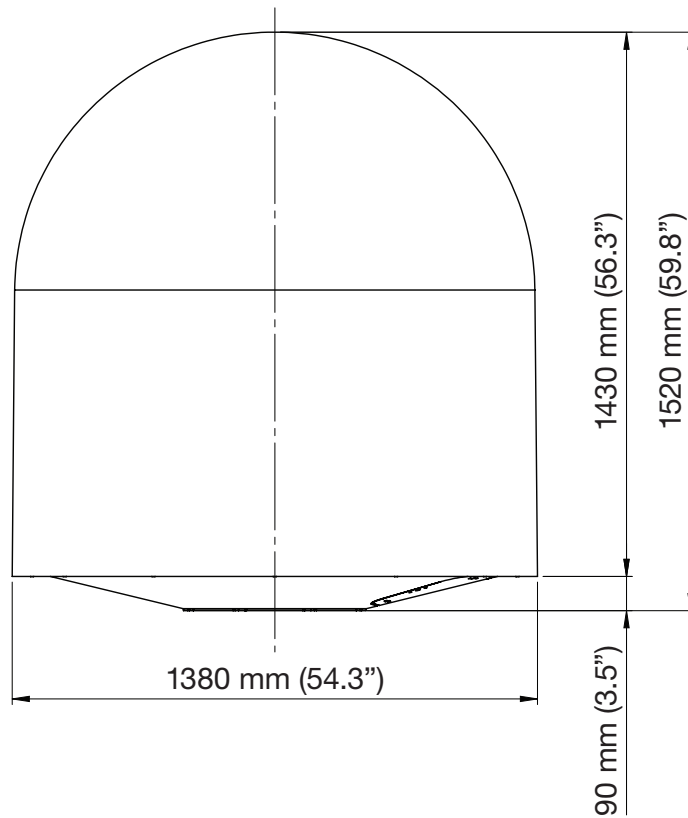

Antenna Mounting Templates

The mounting holes must be in the exact same place as shown in the diagram below.

Antenna Bow direction

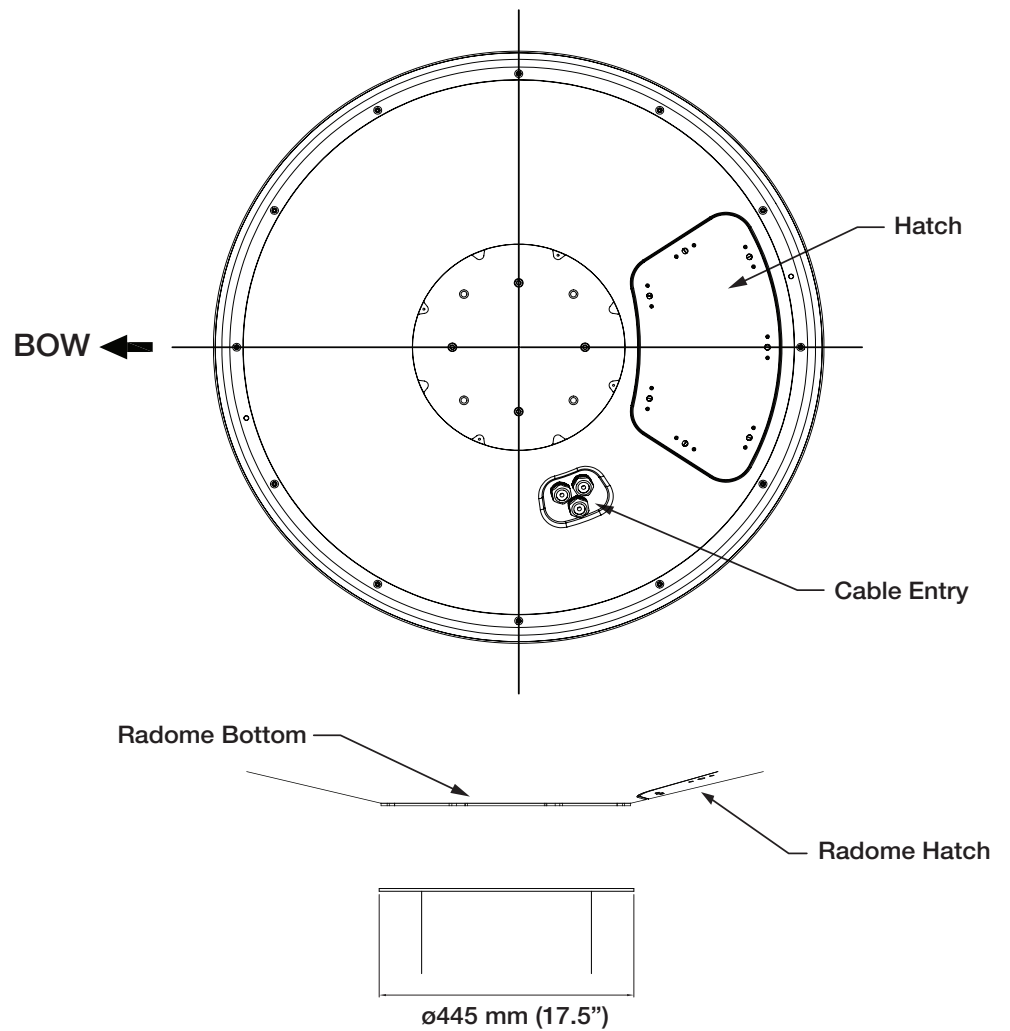

Antenna Mounting Hole Pattern

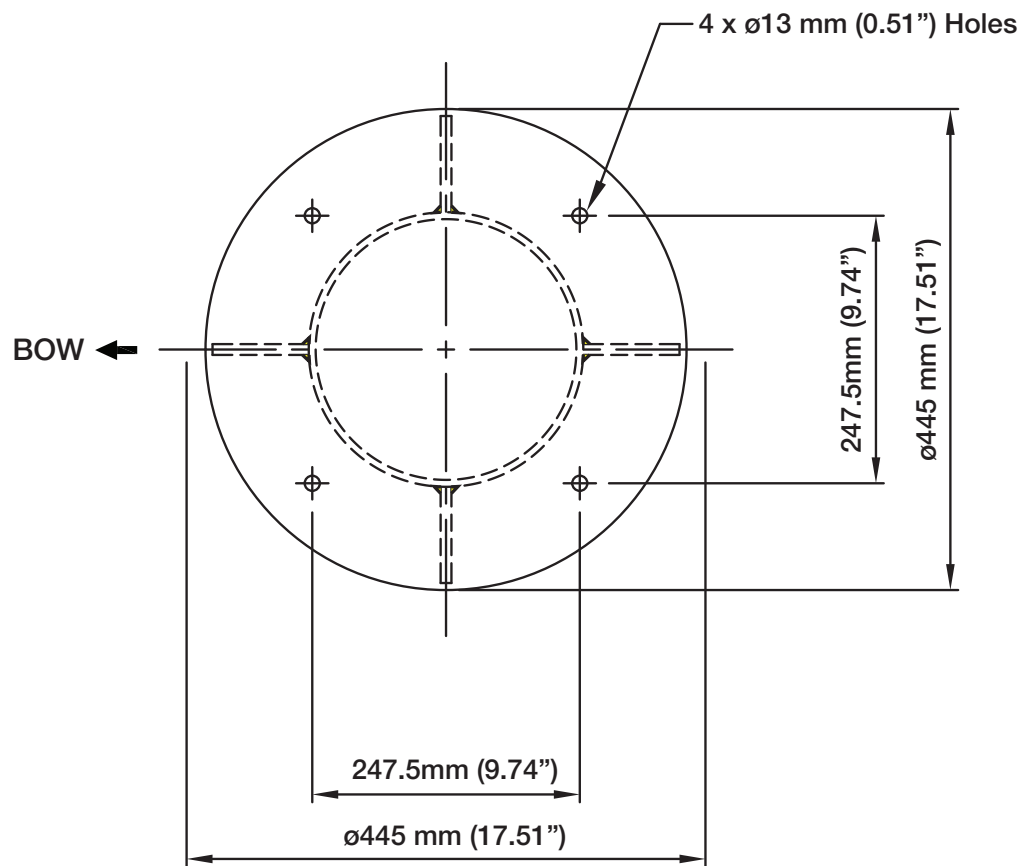

Mast Making Guide

Confirm the height and diameter of the mast before installing it. The mounting holes must be in the exact same place as shown in the diagram below.

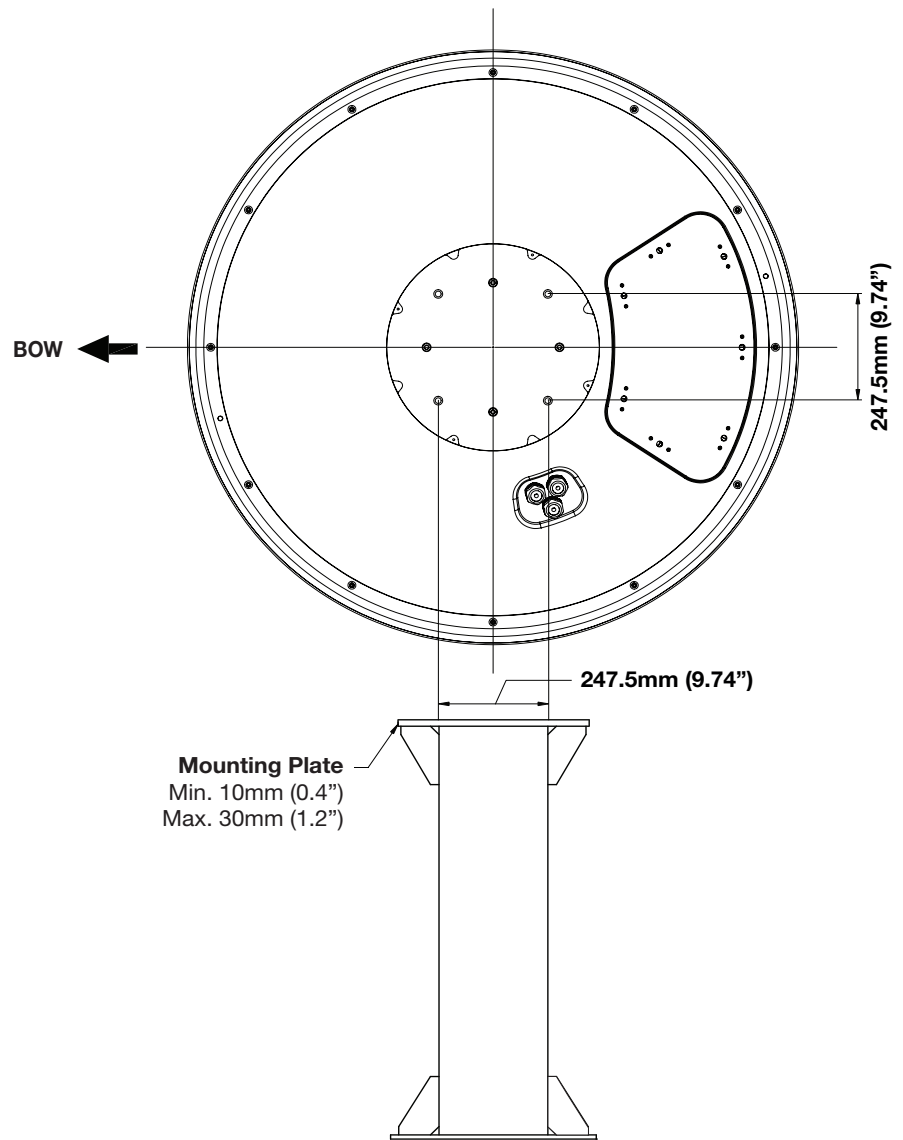

Position the Radome

The radome should be positioned with the BOW marker aligned as closely as possible to the ship's centerline.

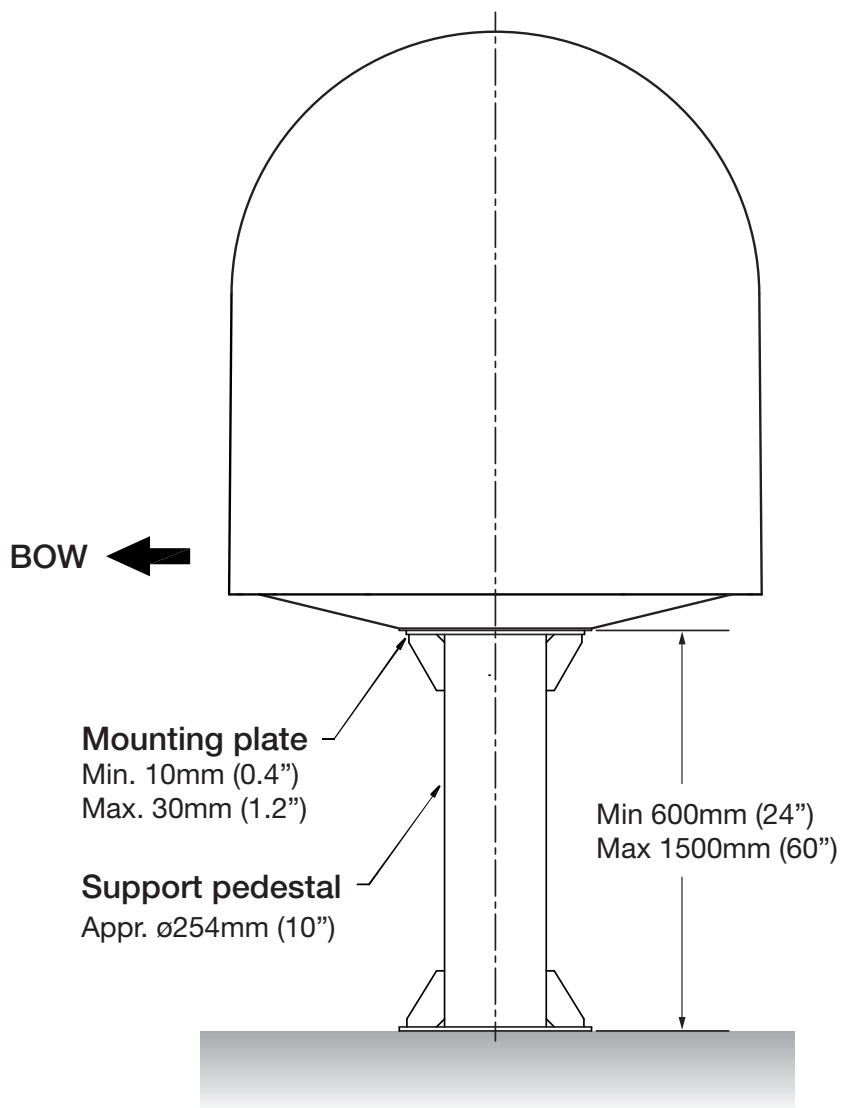

Placing cables on the Mast

The cables must be routed from the antenna and through various areas of the ship to end up at the antenna control unit. When pulling the cables in place, avoid sharp bends, kinking, and excessive force. After placement, seal the deck penetration gland and tie the cables securely in place.

The cable bracket must be installed on the mast to fix the relevant cables.

The gooseneck must be installed on the side of the mast to protect the relevant cables against water.

Placing the cables on the outside of the mast

1. Place the cables from the gooseneck labeled on the deck to the antenna as shown in the picture below.
2. After connecting the cables to cable connectors inside radome hatch, adjust the cable length and then fix the cables on the cable bracket by using cable ties.



WARNING: Ensure that cables have been run through watertight fittings to prevent water entry into the vessel when installation is completed.

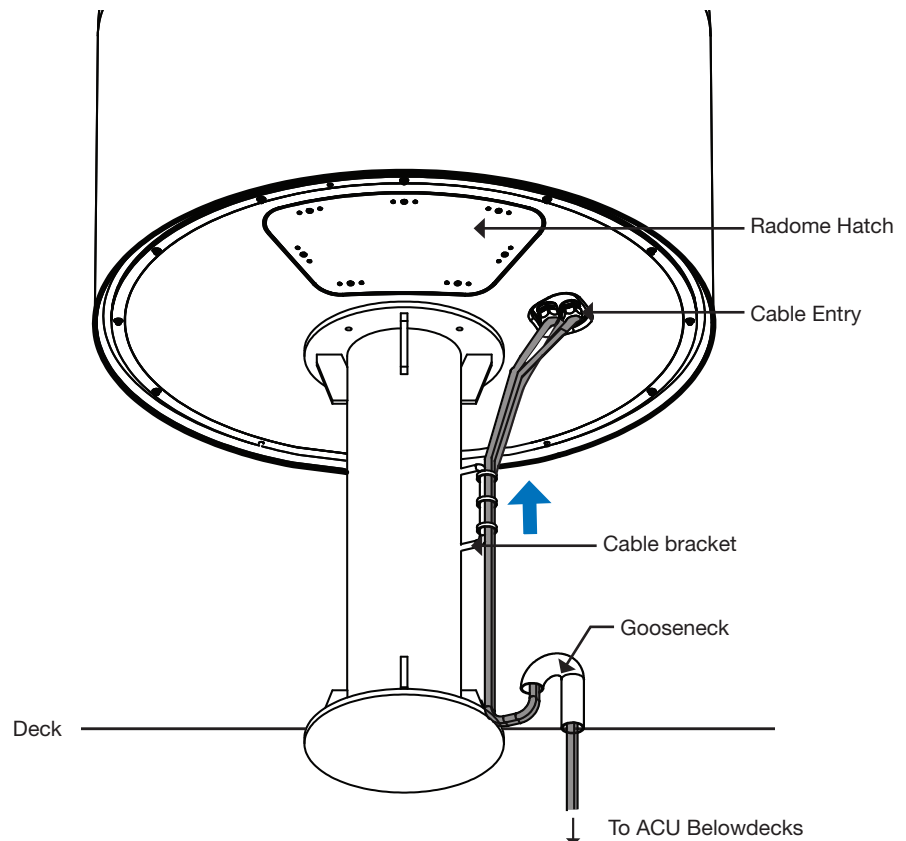

System Cables

Before installing the system cables, you need to take the following points into consideration.

- All cables need to be well clamped and protected from physical damage and exposure to heat and humidity.
- A cable with an acute bend should be avoided.
- Wherever a cable passes through an exposed bulkhead or deck head, a watertight gland or swan neck tube should be used.

RF Cables (Customer Supplied)

Due to voltage/signal loss across the length of the RF coax on L-Band, Intellian recommends the following 75 ohm coax cable types for standard system installations. For cables that run longer than 50 meters, please consult Intellian Technologies.

Run Length	Coaxial Cable Type
Up to 35 meters	RG-6 or LMR-300-75
Up to 50 meters	RG-11 or LMR-400-75

Gyrocompass (Customer supplied)

Type	Multi-conductor, Shielded
Number of wires	2 conductors for NMEA 0183, 5 conductors for NMEA 2000

Antenna Installation

Unpacking the wooden crate

The antenna pedestal is shipped completely assembled in its radome. The pallet should be lifted by means of a suitable sized lifting equipment.

Follow the procedures below.

Step 1.

1. Locate one of the side panels designed for fork lift. Detach this side panel by removing the fixing screw (1EA) and clips (8EA).

①

Tips : Using a Flat-head screwdriver, remove the clip as shown in the picture.

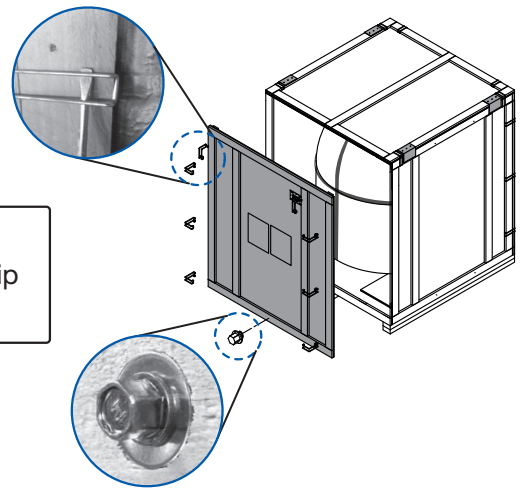

2. Remove the fixing screws (4EA) and clips (6EA) on the top panel. Detach the top panel by carefully pulling it as shown in the picture below.

②

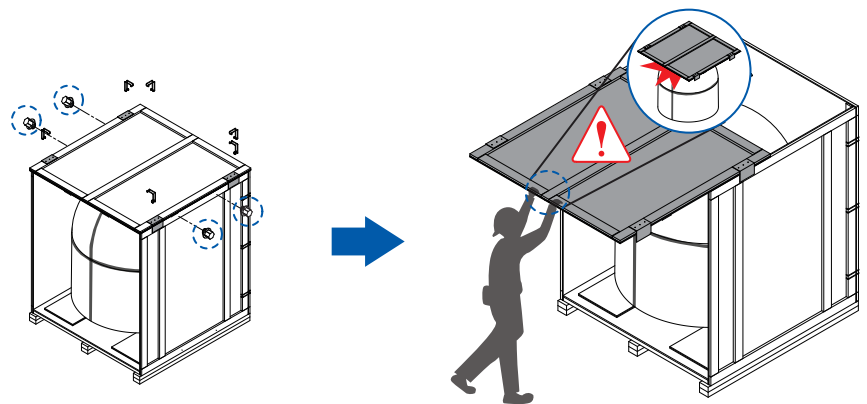

CAUTION: The side brackets at the edge of the top panel secure the side panels and top panel in position. When pulling the top panel, ensure that the top panel doesn't fall on the radome.

3. Remove the fixing screws (5EA) from the remaining side panels, then detach the side panels with clips on.

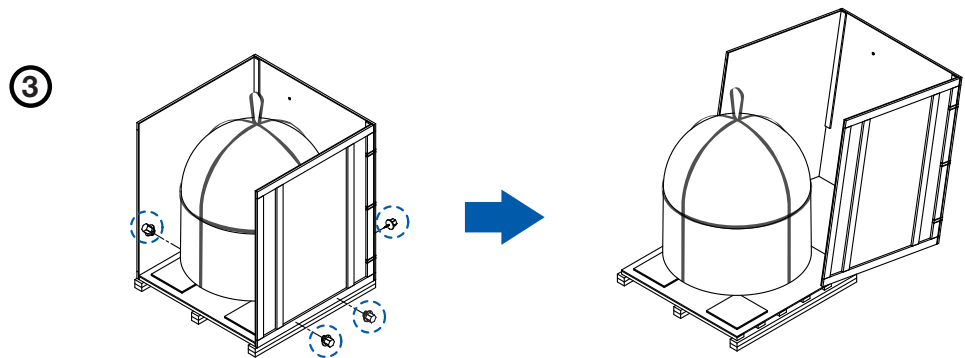

Step 2.

Remove tapping screws from the fixing bracket and take out the ACU box and installation kit box from the pallet.

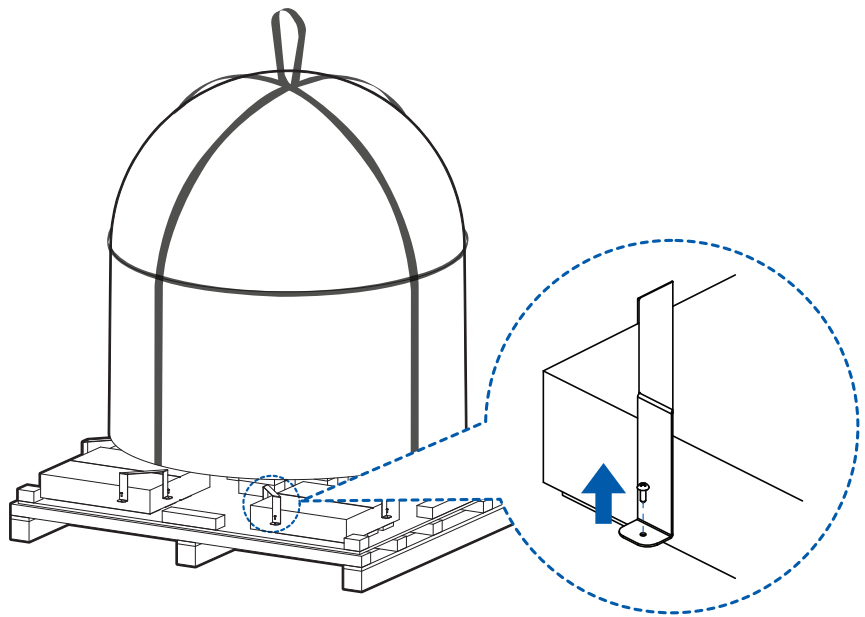

Step 3.

1. Using a 19mm wrench, remove 4 shipping bolts that mount the antenna to the pallet.

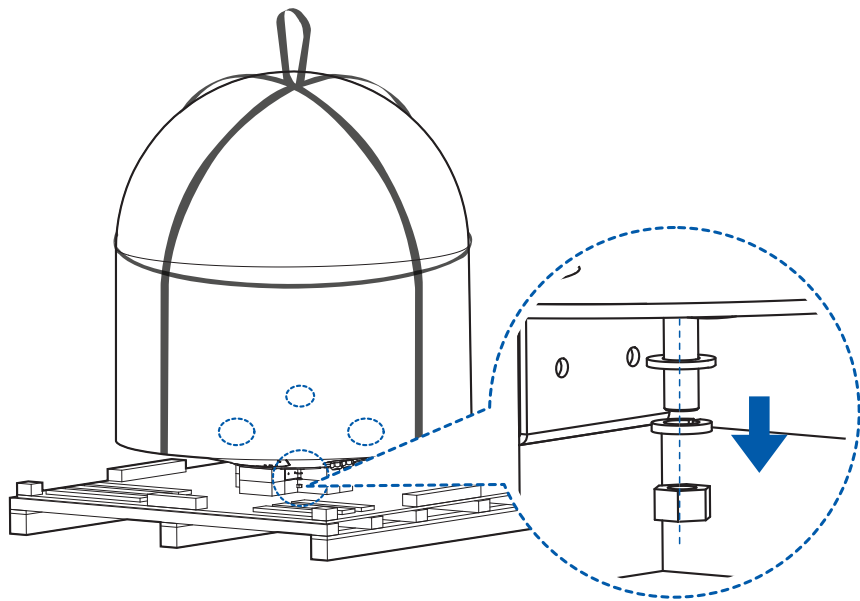

2. Check up the condition of lifting strap and make sure the shackles (2 EA) are tightened. Wrap the shackles with the adequate protection to avoid radome damage.

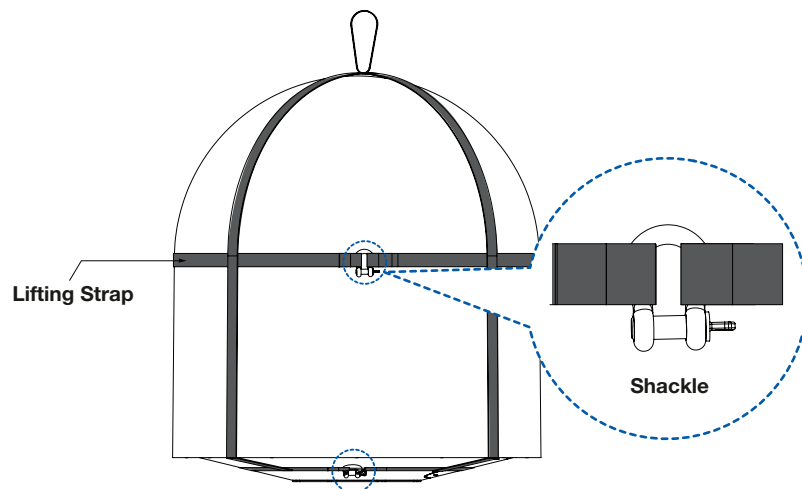

WARNING: When lifting the antenna using the lifting straps, make sure to remove the securing nuts to separate antenna from the pallet.

Placing the antenna on a mast

The Intellian antenna comes with the lifting straps pre mounted from the factory. Check the condition of the lifting strap and that the shackle is tightened up. Ensure the protection is on to avoid damaging the radome.

Lift the antenna above the mast using a crane and carefully place the antenna on the mast.

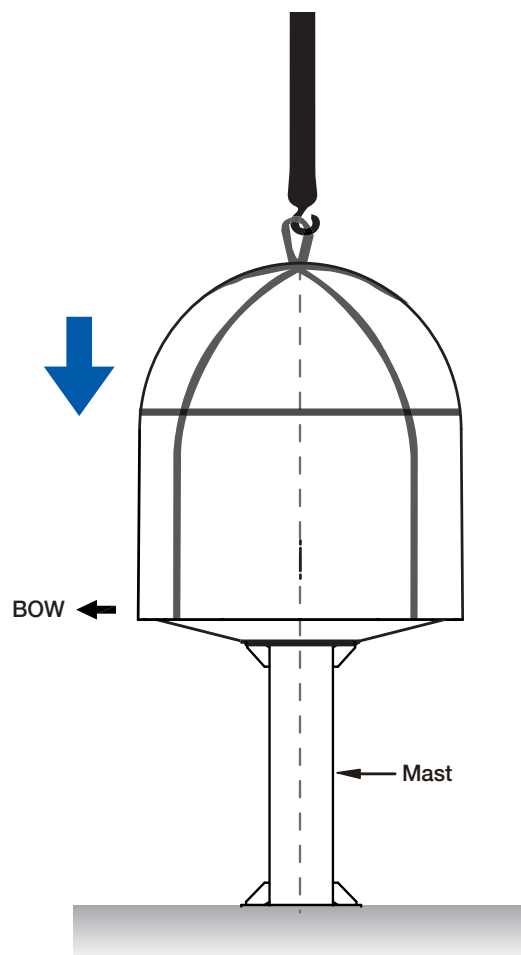

Mounting the Radome

1. Bolt the radome base directly to the support pedestal.

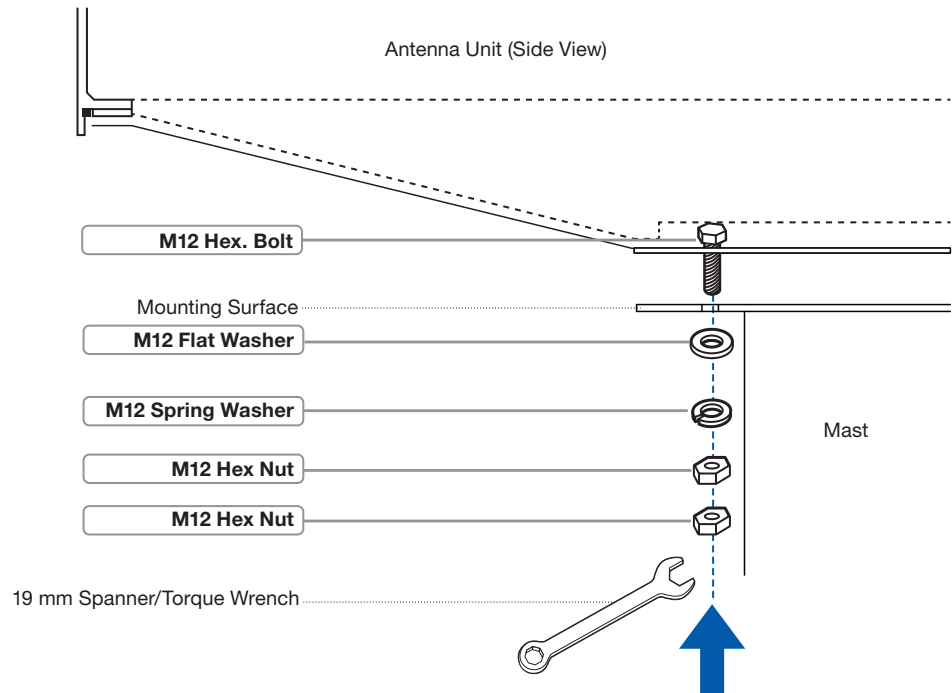

NOTE: Make sure that when you mount the radome, use the tightened bolts on the radome bottom basically. Apply Loctite #262 or equivalent to the bolt thread, and fasten it to a torque setting of 110Nm.

2. Remove the lifting strap.

Remove the Shipping Brackets

1. Make sure that there is sufficient space underneath the ADU to open the service hatch. Through this hatch you access the ADU modules for maintenance. Loosen the bolts (7EA) by using Flat-head screwdriver. Open the radome's hatch and remove the shipping restraints from the pedestal. Gently check that the antenna moves freely in AZ(azimuth), EL (elevation) and CL(cross level) without hitting any part of the radome's interior surface.

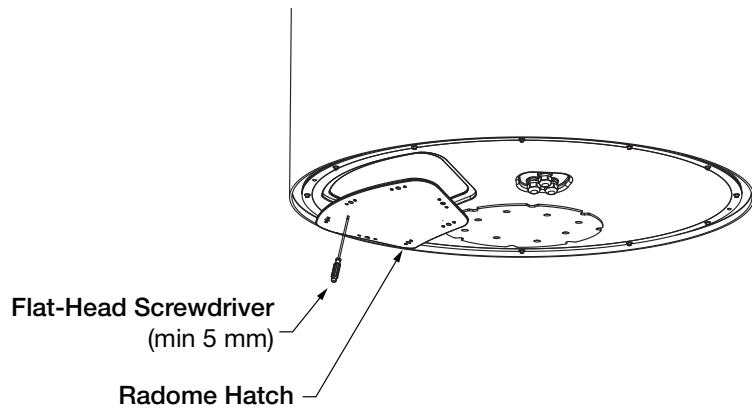

2. Remove shipping brackets securing the AZ axis, EL axis, and CL axis.

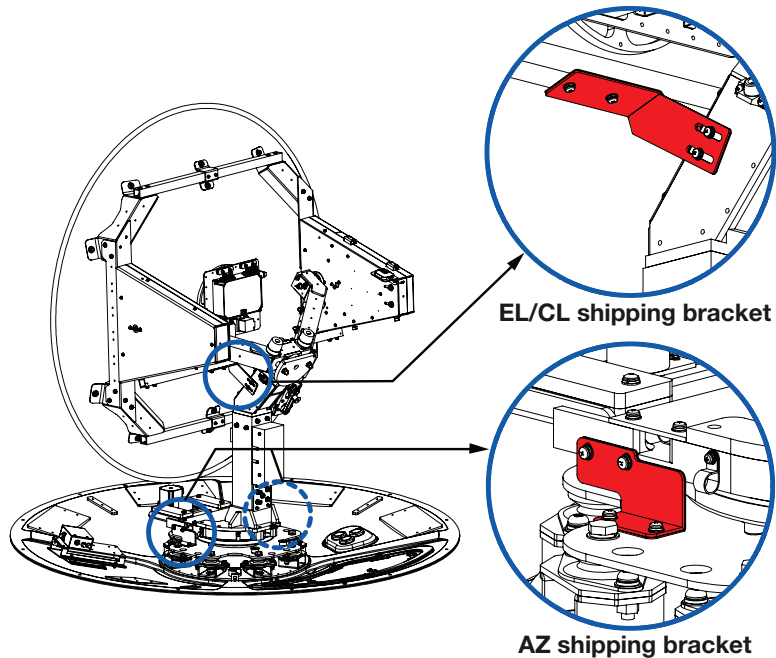

Warning: Please ensure that the Intellian system is ALWAYS powered ON upon leaving the dock. Failure to follow these instructions could result in damaging mechanical parts in the antenna and/or possibly void the warranty. Intellian strongly recommends to restrain the antenna pedestal properly while underway when power is removed from the antenna. The normal operating condition for the antenna is to remain powered up at all times.

Connecting RF Cables

Connect the four(4) RF cables to the RF connectors. Ensure that the power switch is off during the installation period. When all the hardware and cables have been installed, turn on the power switch.

After connecting, seal the cable gland and tie the cables securely in place.

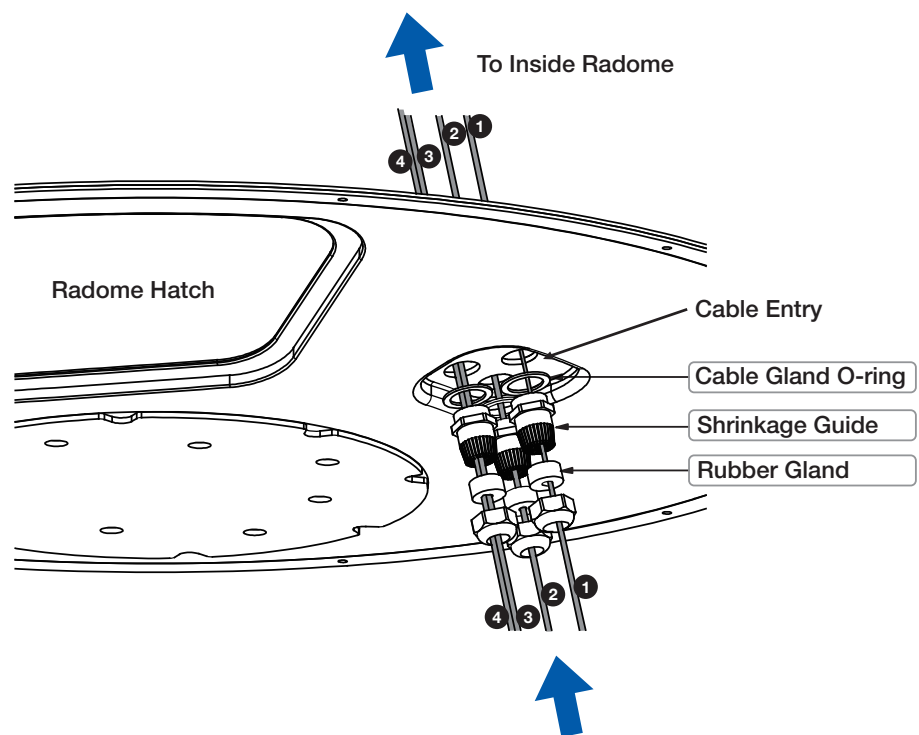

NOTE: There are 3 holes in the cable entry. Insert **1** and **2** cables to inside radome through each hole and insert **3** and **4** cables together through one hole.

Inside Radome View

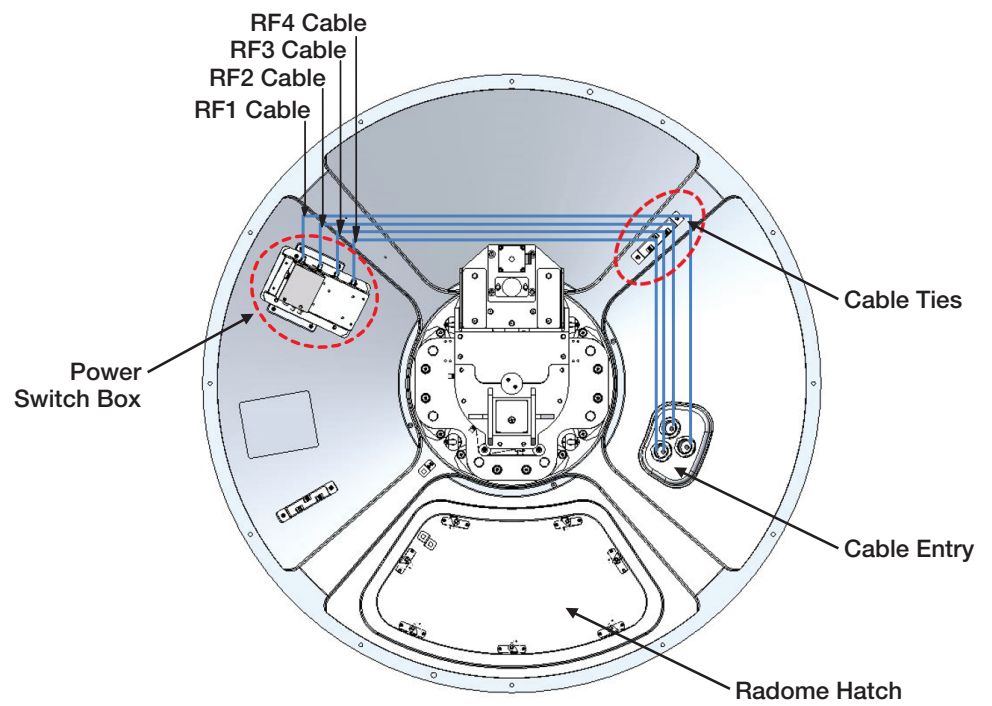

Cable connection of Power Switch Box

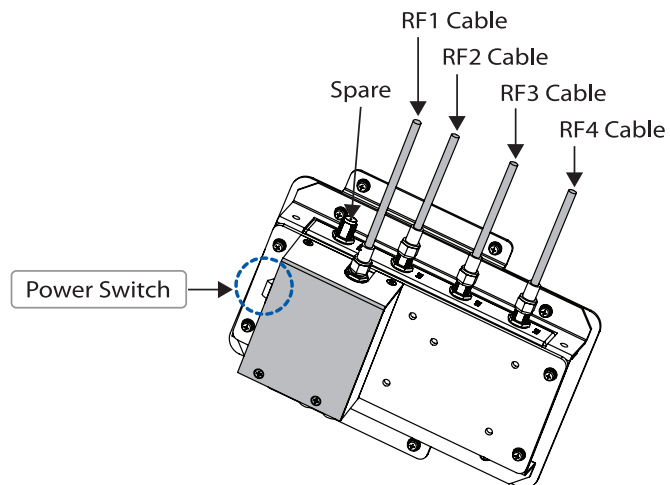

INSTALLING THE ACU

Mounting the ACU/MSM

19 inch Rack Mount Type

Table Mount Type

Mounting the MSM

ACU Dimensions

MSM Dimensions

Selection of ACU Installation Site

Connecting Cables to the ACU

RF Cable Connection

Ship Gyrocompass Connection

Recommended Cable

ACU Connector Guide

Connecting the ACU and MSM

Connecting the MSM and Receiver(s)

PC to ACU Communication Setup

Wi-Fi Connection

Mounting the ACU/MSM

Intellian supplies two types of ACU mounting methods (a) 19 inch Rack Mount Type and (b) Table Mount Type.

19 inch Rack Mount Type

The ACU should be installed using the two supplied Rack Mounting Brackets which allow for a side 19 inch rack mounting configuration.

- Using the Flat Head screws supplied, attach the mounting brackets to the sides of the ACU.
- Place the ACU in the location where it is going to be installed.
- Connect the cables to the rear of the ACU.

Table Mount Type

- The ACU should be installed using the two supplied Table Mounting Brackets which allow for a top or bottom mounting configuration.
- Using the Sems Bolts supplied, attach the mounting brackets to the sides of the ACU.
- Place the ACU in the location where it is going to be installed.
- Using a pencil to mark the 4 hole positions (2 on each side), and use the appropriate drill bit to drill them.
- Connect the cables to the rear of the ACU.

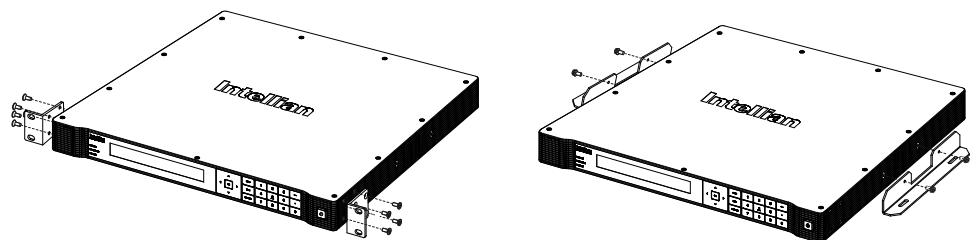

Mounting the MSM

Follow the identical steps for the ACU above to mount the MSM to a rack or table.



WARNING: Ensure that the cables connected to the ACU and MSM are long enough to prevent damage when the ACU and MSM are pulled out from the rack.

ACU Dimensions

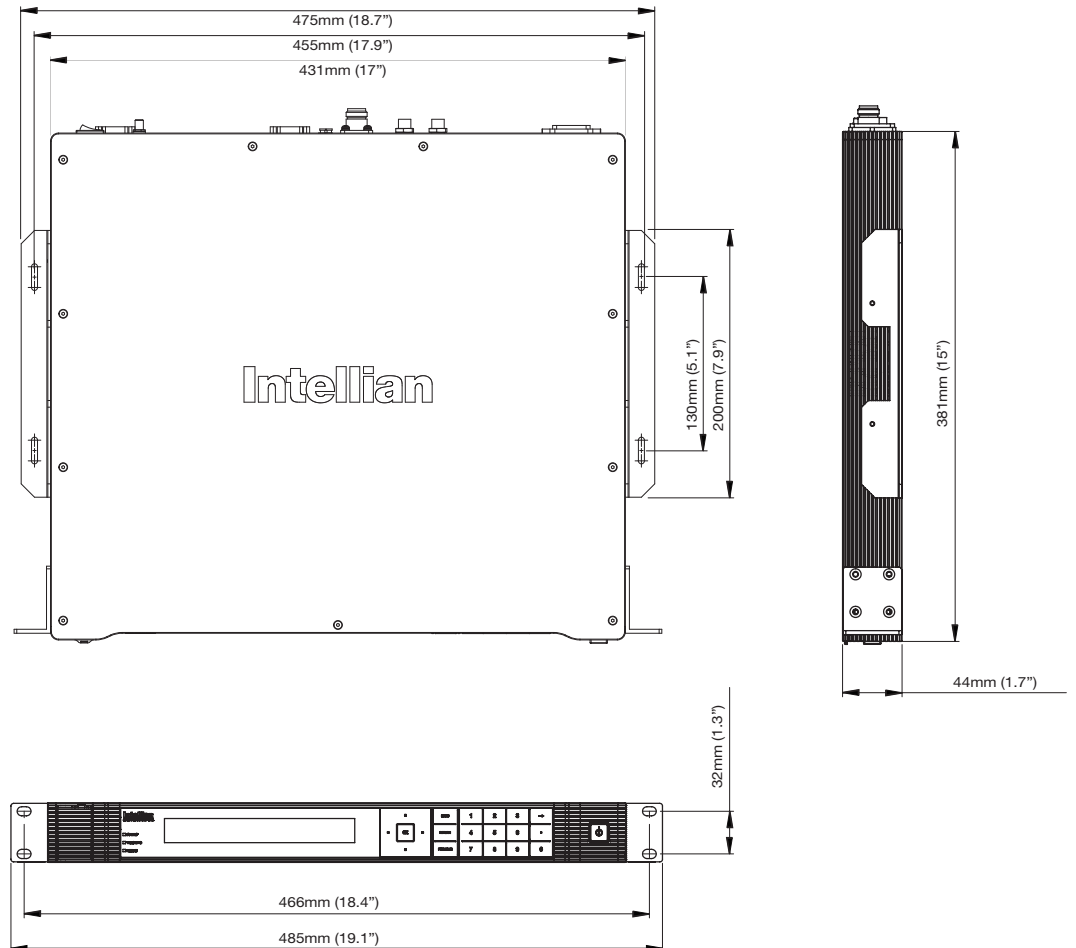

MSM Dimensions

Dimensions of the multi-switch module are identical to the ACU dimensions.

Selection of ACU Installation Site

- The ACU should be installed below deck, in a location that is: Dry, cool, and ventilated.
- Horizontal and solid surface to support the weight of the ACU (7.7 lbs) and all other loads of distribution amplifiers and receivers.

Connecting Cables to the ACU

RF Cable Connection

Connect the two(2) RF cables to the connectors on the rear of the ACU. Connect the "Antenna RF1 Cable" from power switch box inside radome to the "Antenna Rx" connector and the "Multi-Switch Module(MSM) Cable" from multi-switch module to "Receiver" connector as shown in the figure below. Ensure all cables are firmly fastened to the connectors.

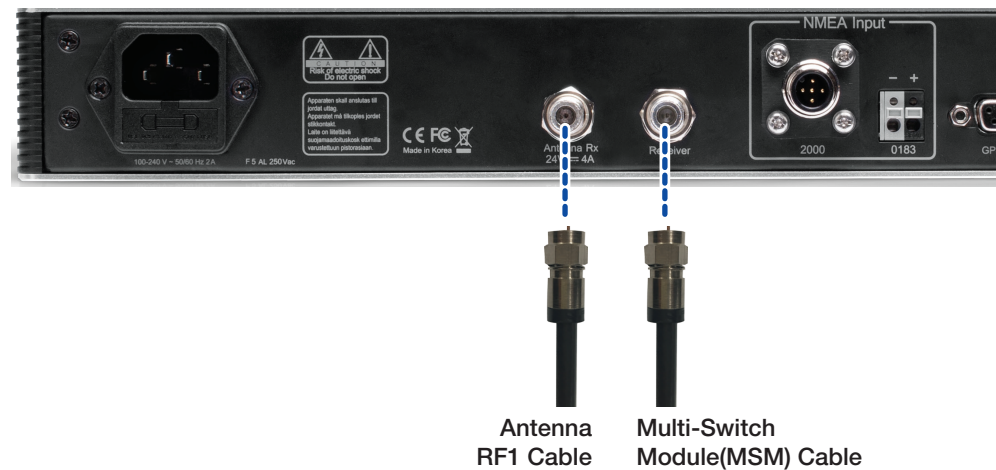

Ship Gyrocompass Connection

For satellite tracking, you must connect a Gyrocompass to the antenna system through the gyrocompass interface on the rear of the ACU. If the ship's gyrocompass output is other than NMEA 0183 and NMEA 2000 a separate purchase of an NMEA converter is required.

Recommended Cable

- NMEA 0183 Gyrocompass Interface Cable (Customer supplied)
- Connector Type: 2 conductors for NMEA 0183, 5 conductors for NMEA 2000
- NMEA heading sentence: xx HDT (4800 Baud, 8, N,1) If there is no HDT sentence then use HDM sentence instead.
- NMEA 2000 heading PGN Number = 127250 (Vessel Heading)



Strip the cable back 5mm (0.2")
Do not solder the cable

ACU Connector Guide

- **NMEA 0183 Connector**

Pin	Signal
-	NMEA 0183 -
+	NMEA 0183 +

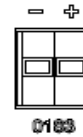

- **NMEA 2000 Connector**

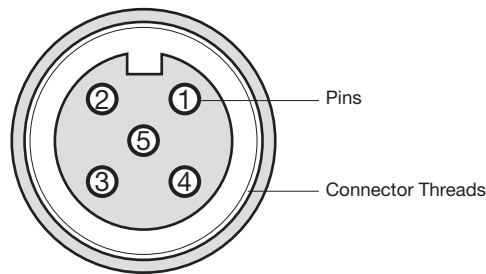

Male Connector

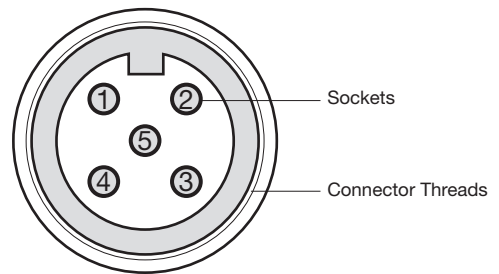

Female Connector

Pin	Signal
1	Shield
2	NET-S, (power supply positive, +V)
3	NET-C, (power supply common, -V)
4	NET-H, (CAN-H)
5	NET-L, (CAN-L)

Pin	Signal
1	Shield
2	NET-S, (power supply positive, +V)
3	NET-C, (power supply common, -V)
4	NET-H, (CAN-H)
5	NET-L, (CAN-L)

- **GPS Connector**

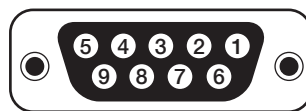

**ACU GPS In/Out Port
D-Sub 9 pin Female**

Pin	Signal
1	GND
2	GPS OUT +
5	GPS IN +

Connecting the ACU and MSM

Ensure to set up and connect the ACU to the Multi-Switch Module.

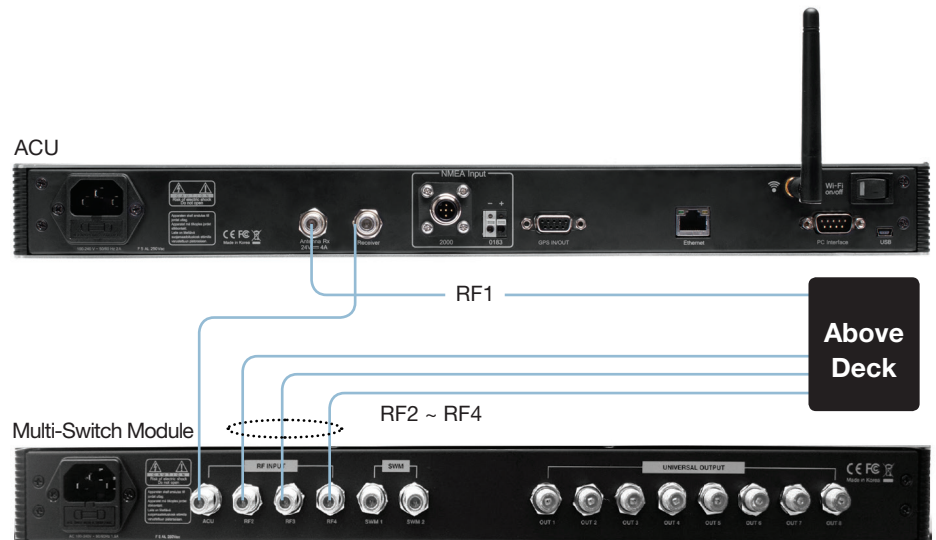

Connecting the MSM and Receiver(s)

Up to 16 SWM compatible receivers and up to 8 non-SWM compatible receivers can be connected through the supplied Multi-Switch Module.

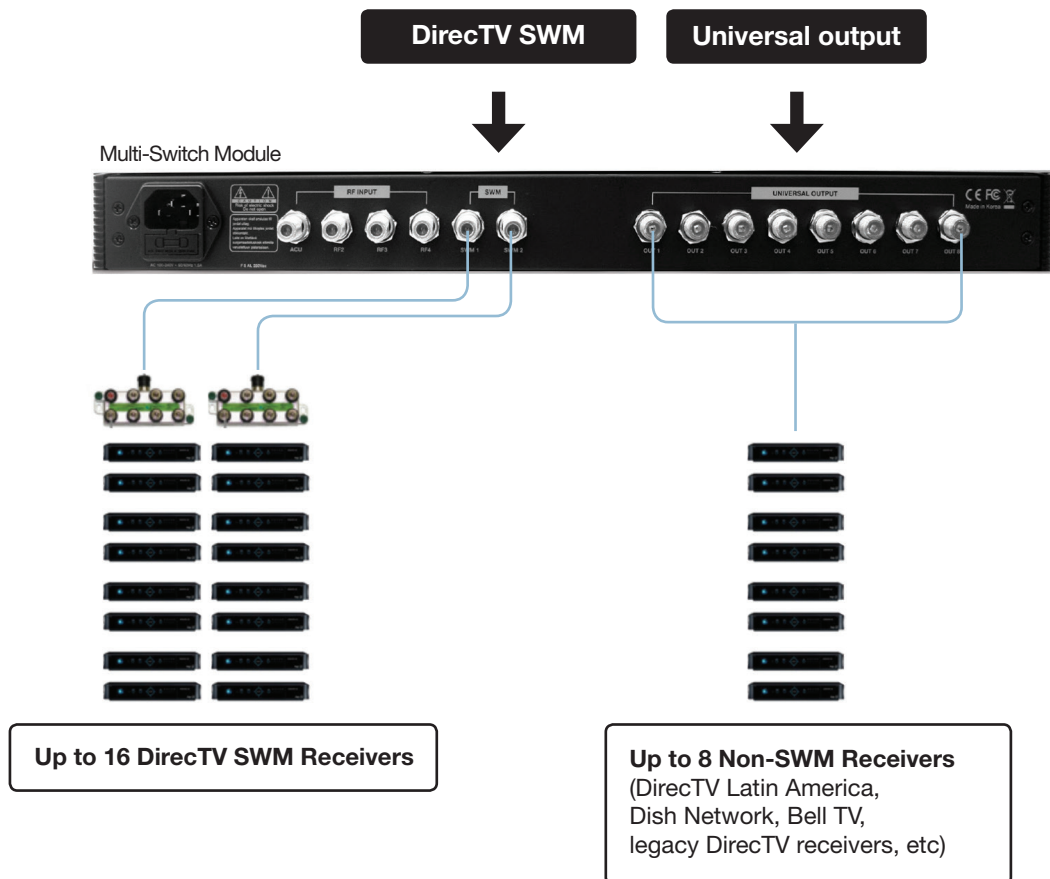

PC to ACU Communication Setup

You can establish data communication between a PC and the ACU using one of the following methods.

TCP/IP Connection

Connection through Front Panel Management Port

This method is most recommended. Network is automatically configured by DHCP without the need of additional PC IP configuration.

Management Ethernet Port

1. Connect an Ethernet cable from a PC Ethernet port to the Management port on the front of the ACU.
2. The network connection is established.
3. Use the following IP address to access Intellian Aptus® or Aptus Web page.
 - **192.168.2.1 (Default)**



Connection through Rear Panel Ethernet Port

This method requires separate IP configuration on a PC.

- Ethernet Port
1. Connect an Ethernet cable from a PC Ethernet port to an available LAN port of a Switch/Hub.
 2. Go to Control Panel > Network and Sharing Center > Change Adapter Settings and right-click on the Local Area Connection then click Properties
 3. Select TCP/IPv4, then click Properties.
 4. Change the network settings on a PC;
 - **Default IP: 192.168. 0.222 (Secondary: 10.10.1.2)**
 - **Subnet Mask: 255.255.255.0**
 - **Gateway: 192.168.0.223 (Secondary: 10.10.1.1)**
 5. Use the following IP address to access Intellian Aptus® or Aptus Web page.
 - **Default: 192.168.0.223 (Secondary: 10.10.1.1)**



USB/Serial Connection

Connection through USB Port

There are two USB (USB-to-Serial) ports available on the ACU. One is on the front and the other is on the rear.

USB Connection

1. Connect a USB cable from a USB port on your PC to the upper USB port on the ACU.

Front panel



Rear panel



Connection through Serial Port

Serial Connection

1. Connect the supplied 9-pin Serial cable from the PC INTERFACE connector on the ACU to the 9-pin serial port on your PC.
2. If there is not a 9-pin serial port on the PC, use the supplied USB-Serial adapter.



Wi-Fi Connection

Setup Wi-Fi Connection

- Setting up the ACU in order to access Wi-Fi
- Setting up the PC (AP Mode) in order to access Wi-Fi
- Remote Aptus web Confirmation

Setting up the ACU in order to access Wi-Fi

1. Turning on the Wi-Fi switch

Turn on the switch on the back of the ACU, and 30 seconds after enabling the power supply, confirm if a red light appears on the switch.

Wi-Fi Quick Reference:

- **SSID: Intellian-TVRO**
- **PW: Intellian1234**
- **PC IP: 192.168.1.222**
- **Subnet Mask: 255.255.255.0**
- **GateWay: 192.168.1.223**



Setting up the PC in order to access Wi-Fi

1. Setting up computer's wireless IP address

- Control Panel > Network and Sharing Center > Change Adapter Settings > Right click on the "Bluetooth Wireless Connection" > Click Properties

After selecting TCP/IPv4, click on the properties menu, then select "Obtain an IP address automatically."

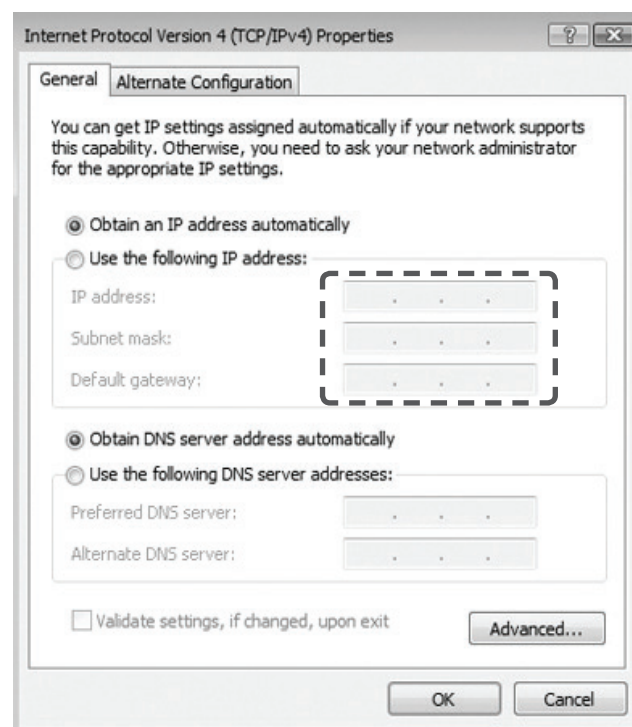

2. To manually change the network settings, click on "Use the following IP address" and use the settings listed below.

Case #1

If iARM Module's IP is known

The iARM module's default IP is 192.168.1.223

PC IP: 192.168.1.222

Subnet Mask: 255.255.255.0

GateWay: 192.168.1.223

Case #2

iARM Module's IP is unknown

The iARM module's secondary IP is 10.10.10.1

PC IP: 10.10.10.2

Subnet Mask: 255.255.255.0

GateWay: 10.10.10.1

3. Connect Wi-Fi in AP mode.

After clicking on the Windows Wireless Connection icon, click on intellian-TVRO (Default).

4. Enter the Network Security Key.

Key: intellian1234 (Default)



5. You can confirm the logo and version data by accessing <http://192.168.1.223>

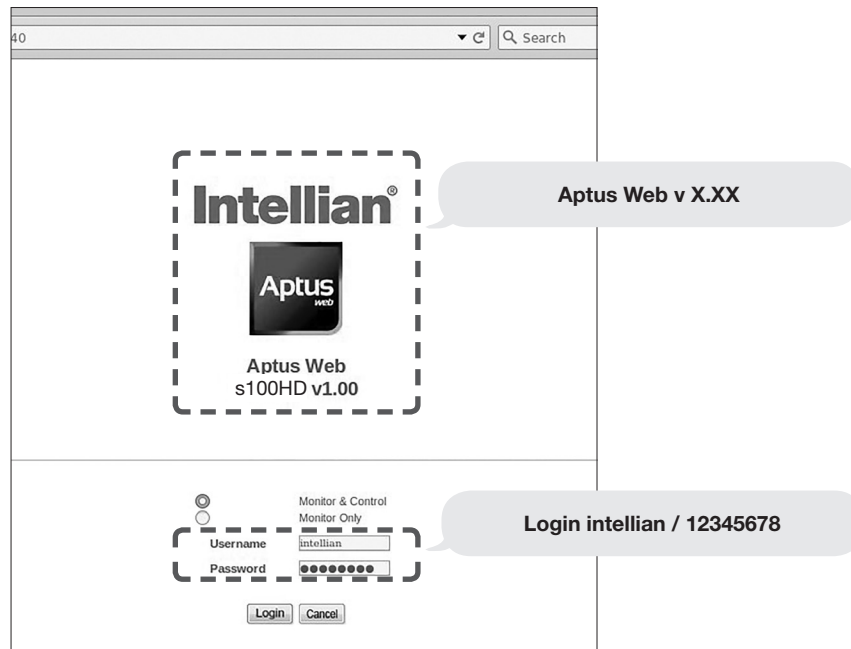

Login by entering the ID / Password listed below.

Username: intellian (Default)

Password: 12345678 (Default)

6. When you login, make sure that all the data within every page is being displayed correctly.

OPERATING THE ACU

Introduction

Normal Mode

Startup

Change of Target Satellite

Monitoring Current Status

Setup Mode

Installation Settings

Installation

Antenna Settings

Setting Antenna Manual Search

Antenna LNB Skew Angle

Setting Antenna Search Parameter

Setting Antenna Parameters

Performing Antenna Diagnostic Tests

Satellite Settings

Setting the Satellite Pair

Edit Satellite Information

Setting the Region

Finding the Transponder

System Settings

Setting the GPS and Gyrocompass

System Management

Key Lock / Password Management

Introduction

This section of the handbook covers Intellian Antenna Control Unit (ACU) functions, menu's and options.

Normal Mode

- System startup
- Change of target satellite
- Monitoring current status

Starting Setup Mode

Installation Setting

Setting the Antenna

- Setting antenna manual search
- Setting antenna set skew
- Setting antenna search parameter
- Setting antenna set parameters
- Executing antenna diagnosis

Setting the Satellite

- Setting the satellite pair
- Edit satellite information
- Setting the region
- Finding transponders

Setting the System

- Setting the GPS and Gyrocompass
- System Management
- System backup & restore
- Copy log and firmware upgrade through USB
- Supports Wi-Fi ACU operation
- Built-in web-based remote control management
- Front panel Management Ethernet port

Note: Intellian recommends authorized technicians to perform advanced parameter changes outside of Intellian default parameters. Changes to parameters will effect antenna performance.

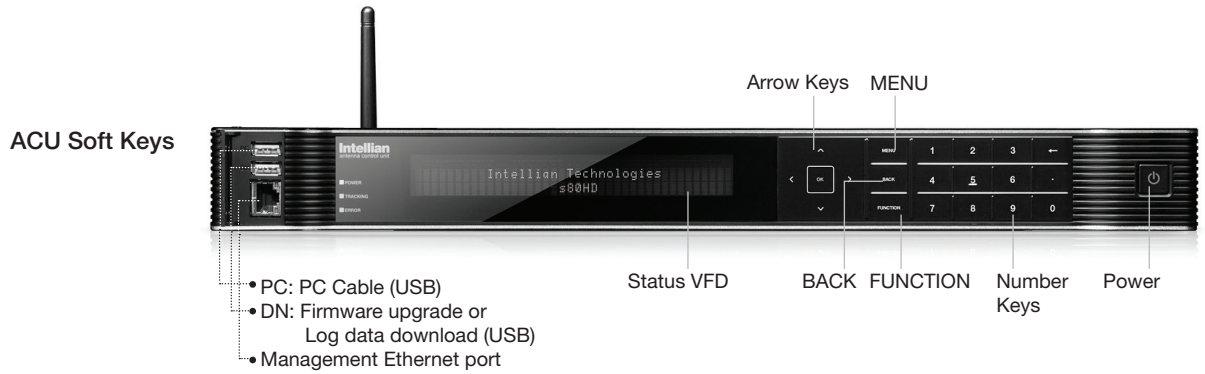

Soft Key Functions

Soft key	Function
MENU	Enter SETUP mode
BACK	In SETUP mode: returns to the previous menu / option or save the adjusted settings. In normal mode: returns to the first page of the antenna's current status.
FUNCTION	Save the adjusted settings.
ARROW KEYS	Select from the alternative options to increase or decrease the selected character to the desired value.
OK	Enter the next step / menu
NUMBER KEYS	Input the numbers

Normal Mode

Startup

With the system installed and power applied, the ACU screen will show the following sequence.

```
INTELLIAN TECHNOLOGIES INC.
INTELLIAN s100HD
```

1. The data communication is being established between the antenna and the ACU.

```
INITIALIZE – ANTENNA INFO
INTELLIAN s100HD
```

2. The ACU receives antenna information.

```
INITIALIZE – EL POSITION
INTELLIAN s100HD
```

3. The elevation angle and cross level angle are initialized.

```
INITIALIZE – AZIMUTH POSITION
INTELLIAN s100HD
```

4. The azimuth angle is initialized.

```
INITIALIZE – FIND NOISE LEVEL
INTELLIAN s100HD
```

5. The antenna measures the noise levels of the default satellites.

```
INITIALIZE – SAT POSITION
INTELLIAN s100HD
```

6. The antenna returns to the target satellite position.

```
SEARCH3 DTV101 AGC: 301 ● [VL] ▸
AZ: 292.7 ( 202.7) EL: 48.3 SK: ▲-72.0 ▸
```

7. The antenna has locked onto the satellite.

```
TRACKING DTV101 AGC: 501 ● [VL] ▸
AZ: 292.7 ( 202.7) EL: 48.3 SK: ▲-72.0 ▸ Fn
```

8. The antenna has locked onto satellite [1] and is now tracking.

Change of Target Satellite

The system is programmed for three target satellites as a default.

To change the target satellite, press the LEFT soft key. The target satellite is changed and is automatically tracked by the antenna.

```
# TRACKING [↔] ASTRA_1          ↵
                [2] HOT_SPOT  [3] ASTRA_3  Fn
```

1. Press key 2 for tracking satellite [2].

```
# TRACKING [↔] HOT_SPOT         ↵
                [1] ASTRA_1   [3] ASTRA_3  Fn
```

2. The antenna is tracking satellite [2].

```
# TRACKING [↔] ASTRA_1          ↵
                [1] HOT_SPOT  [3] ASTRA_3  Fn
```

3. Press key 3 for tracking satellite [3].

```
# TRACKING [↔] ASTRA_3          ↵
                [1] ASTRA_1   [2] HOT_SPOT  Fn
```

4. The antenna is tracking satellite [3].

Monitoring Current Status

While POWER ON the Intellian s100HD ACU displays the status of the antenna. Various ACU displays may be shown according to the current status of the antenna.

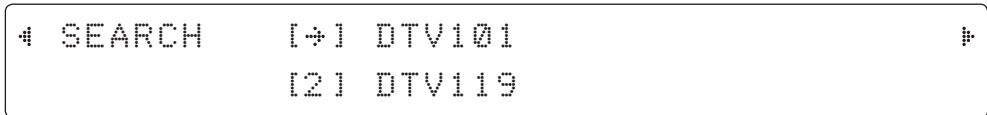

1. The antenna is searching for satellite [1].

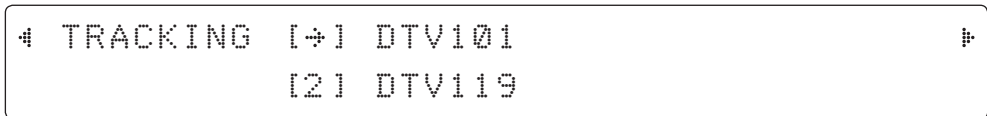

2. The antenna is tracking satellite [1].



3. The antenna is unwrapping the cable wrap inside the antenna. Unwrapping is based on ships rotation in one direction that exceeds the 680° azimuth range of the antenna.

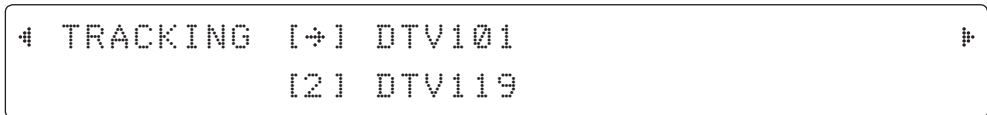

4. The antenna is again tracking satellite [1].

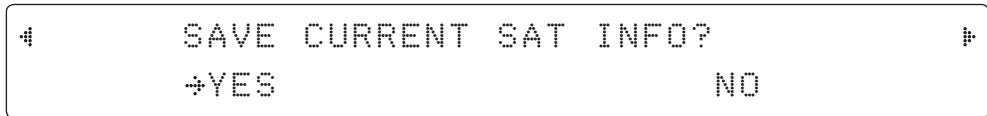

5. Press the OK key to save current satellite information or press the RIGHT arrow key to NO and press OK to abort changes and return to the main display.

```

# TRACKING [↔] DTV101      ↵
                [2] DTV119      Fn

```

6. While the antenna is tracking satellite [1], press the RIGHT arrow key to display current antenna information.

```

# TRACKING 19.2E DTV101  AGC: 301*   VL  ↵
  AZ: 160.9( 340.9) EL: 29.0 SK: -21.1  Fn

```

7. True azimuth [160.9] position of the antenna is the sum of ships heading 180.0 [HDG] and antenna relative [340.9]. Current IF signal level (AGC) is displayed.
- will be only displayed when signal is strong enough to lock. VL indicates vertical low band. VH: vertical High, HL: horizontal low, HH: horizontal high.
- Press the UP and DOWN arrow keys to increase and decrease the LNB skew angle. If the Up and Down arrow keys are unseen, press the OK key three times.

```

# DVB_D F: 11856 S: 27500 X0001 AGC: 124  ↵
  127.05E 41.50N  HDG: 180.0   L: 9750

```

8. Press the RIGHT arrow key to display current satellite, GPS and ship's heading [HDG] information.

Satellite Information:

Verification method: DVB_D [DVB_Decode]

Frequency: 11856

Symbol Rate: 27500

NID: x0001

LNB local frequency: 9750

GPS Information:

Longitude: West/East

Latitude: North/South

Ship's Heading Information:

HDG: 180.0

```

┌ IPWR ─┐ ANT: 23.9V      LNB: 13V + 0KHz  ─┐
└────────┘ ACU: 27.0V      IRD: 13V + 0KHz
    
```

9. Press the RIGHT arrow key to display ACU and antenna, LNB and IRD voltage information.

Antenna and ACU Voltage:

Due to the voltage losses across the RF1 coaxial cables, ensure that the minimum ACU operation voltage is within 27 + 1 V DC and the minimum antenna operation voltage is above 16V DC.

LNB and IRD Voltage:

Voltage		DiSEqC		Description
13V	18V	0KHz	22KHz	
•		•		Vertical Low
	•	•		Horizontal Low
•			•	Vertical High
	•		•	Horizontal High

```

┌ T3-87AT ─┐ ANT. Serial 1.00/1.00 ─┐
└────────┘ BP-TA51 ACU Serial 1.00(1.00)
    
```

10. Press the RIGHT arrow key to display the antenna, ACU and Library version. Keep pressing the RIGHT arrow key to return to the main display.

Setup Mode

Follow instructions below to enter SETUP mode.

```
⊕ TRACKING [⊕] DTV101      ⊕  
                [2] DTV119      Fn
```

1. While the antenna is tracking, press the MENU key for setup menu.

```
                SETUP MENU ?  
⊕YES                NO
```

2. Press the LEFT key to move cursor to YES and press the OK key to enter setup menu or press the RIGHT key to move cursor to NO and press the OK key to abort and return to the main display.

Installation Settings

Installation

```
                SETUP MODE ?
          +YES                               NO
```

1. Press the LEFT arrow key to move cursor to YES and press the OK key to enter setup mode.

```
+ANTENNA                +SATELLITE
+SYSTEM                  ++INSTALLATION
```

2. Press the arrow key to move cursor to INSTALLATION and press the OK key to enter **INSTALLATION** menu.

```
SELECT CONTINENT      SELECT REGION
▲  N AMERICA  ▼      LOS_ANGELES
```

3. Set the **CONTINENT & REGION**.
Press the UP and DOWN arrow keys to select the continent & region that you are in. Press the OK key to set the settings.

```
LATITUDE                LONGITUDE
▲ 34.29N ▼              118.15W
```

4. Set the current **LATITUDE**.
Press the LEFT and RIGHT arrow keys until the desired character is underscored (selected). Press the UP and DOWN arrow keys to increase or decrease the value. Or, press the NUMBER keys to set the desired value directly.
Press the OK key to set the **LATITUDE**.

LATITUDE	LONGITUDE
34.29N	118.15W

5. Set the current **LONGITUDE**.

Press the LEFT and RIGHT arrow keys until the desired character is underscored (selected). Press the UP and DOWN arrow keys to increase or decrease the value. Or, press the NUMBER keys to set the desired value directly.

Press the OK key to set the **LONGITUDE**.

GYRO TYPE	BOW OFFSET
NMEA	000

6. Set the **GYRO TYPE**.

Determine the type of gyrocompass that is used on the ship. Ensure that the Gyro Type is set correctly. Press the UP and DOWN arrow keys to select the gyrocompass type and press the OK key to set the GYRO TYPE.

GYRO TYPE	BOW OFFSET
NMEA	000

7. Set the **BOW OFFSET**.

The radome should be positioned with the BOW marker aligned as close as possible to the centerline of the ship. Small variations from actual alignment can be compensated with the BOW OFFSET, so precise alignment is not required.

Press the LEFT and RIGHT arrow keys until the desired character is underscored (selected). Press the UP and DOWN arrow keys to increase or decrease the value. Or, press the NUMBER keys to set the desired value directly.

Press the OK key to set the **BOW OFFSET**.

```
                                LOAD ?
                                +YES                                NO
```

8. Press the LEFT key for YES then OK to load the current settings or OK for NO and abort and return to the main display.

```
LOADING . . . ●●●○○○○○○○○○○○○○○○○○○○○
DO NOT TURN OFF !
```

9. Setting is being loaded to the system.
The ACU will restart the system automatically after uploading the setting.
DO NOT turn off ACU power while uploading is being processed.

```
4 SEARCH    [→] DTV101    →
              [2] DTV119
```

10. Region information has been updated.

Connecting the system without a Ship's Gyrocompass

For a vessel where the ship's gyrocompass is not installed or is difficult to be connected, the Intellian Gyro-Free satellite search function will be automatically enabled to allow the antenna to lock onto the desired satellite without requiring an external heading input.

The table below provides an example of the Gyro-Free satellite search algorithm. The Search 1 or Search 3 satellite search pattern will be triggered according to the existence of heading input and the setting of the heading device.

Search 1: The antenna will search for the target satellite by turning its azimuth angle in CCW(Counter Clockwise) direction until the antenna receives the lock signal from the modem or the DVB(Digital Video Broadcasting) transponder of the target satellite is decoded by the antenna.

Search 3: The antenna will search for the target satellite by turning its azimuth angle directly to the position calculated using the ship's heading input and lock onto the satellite.

Setting of Heading Device			
Existence of Heading Data	None	NMEA / NMEA 2000	Ground Test
With Heading Data	Search 1	Search 3	Search 3
Without Heading Data	Search 1	Search 1	Search 3

Quick Setup Procedure

- Select the desired target satellite.
- Select "No Device" as the heading device type.
- The antenna will search for the target satellite by turning its azimuth angle in CCW direction and lock onto the satellite signal until the antenna receives a lock signal from the receiver or the DVB transponder of the target satellite is decoded.
- Set the heading device as NMEA.
- Enter "Manual search" menu and touch "Function" key to save the current settings. Intellian ACU will automatically calculate and save the bow offset.

Antenna Settings

Setting Antenna Manual Search

```

                SETUP MODE ?
          ↗YES                NO
    
```

1. Press the LEFT key to move cursor to YES and press the OK key to enter setup mode.

```

    ↗+ANTENNA                +SATELLITE
      +SYSTEM                +INSTALLATION
    
```

2. Press the OK key to enter **ANTENNA** menu.

```

    ↗+MANUAL SEARCH          +SET POL ANGLE
      +SEARCH PARAM          +SET PARAMETERS
    
```

3. Press the OK key to enter **MANUAL SEARCH** menu.

```

STEP SIZE  AZIMUTH  ELEVATION  AGC
#  0.2    #  ↖ 288.7  ↗  41.0  ↘  288  Fn
    
```

4. Current IF signal level (AGC) is displayed to assist you in manually peaking EL for best signal level. Press the NUMBER key to change the step size. (Range: 0.1~9.9) Press the LEFT and RIGHT arrow keys to move azimuth by step size. (Range: 0~360) Press the UP and DOWN arrow keys to move elevation by step size. (Range: 0~90)

```

                SAVE CURRENT SAT INFO ?
          ↗YES                NO
    
```

5. Press the FUNCTION key to save current value or abort and return to the main display. If the current settings are able to locate the satellite, press the LEFT key to move cursor to YES and press the OK key to save the settings. It will shorten the satellite acquisition time next time. Or you can press the RIGHT key to move cursor to NO and press the OK key to abort and return to the main display.

Antenna LNB Skew Angle

```

                SETUP MODE ?
          ↵YES                               NO
    
```

1. Press the LEFT key to move cursor to YES and press the OK key to enter setup mode.

```

    ↵↵ANTENNA                               +SATELLITE
      +SYSTEM                               +INSTALLATION
    
```

2. Press the OK key to enter **ANTENNA** menu.

```

    ↵  +MANUAL SEARCH  ↵↵SET POL ANGLE  ↵
      +SEARCH PARAM   +SET PARAMETERS
    
```

3. Press the RIGHT arrow key to move cursor to SET POL ANGLE and press OK key to enter **SET POL ANGLE** menu.

```

                SELECT LNB POL. ANGLE MENU
          ▲                CALIBRATION                ▼
    
```

4. Press the UP and DOWN arrow keys to select the skew type and press the OK key to run one of the selected operations: '**CALIBRATION**' or '**MANUAL ADJUST**'. When you replace the control board, select CALIBRATION to calibrate LNB skew angle.

```

    LNB POL ANGLE  POLARITY  SIGNAL: 180
          ▲ 20 ▼      ↵ LINEAR ↵
    
```

5. Press the UP and DOWN arrow keys to increase or decrease the LNB pol angle manually. Press BACK key to return to the main display.
6. Press the LEFT and RIGHT arrow keys to select the polarization between Linear and Circular. Press BACK key to return to the main display.

Setting Antenna Search Parameter

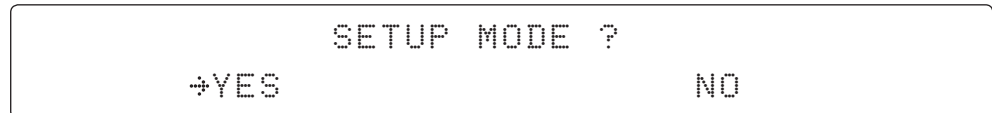

1. Press the LEFT key to move cursor to YES and press the OK key to enter setup mode.

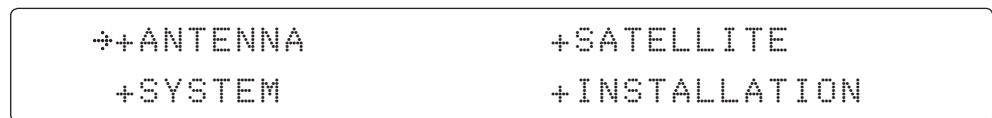

2. Press the OK key to enter **ANTENNA** menu.

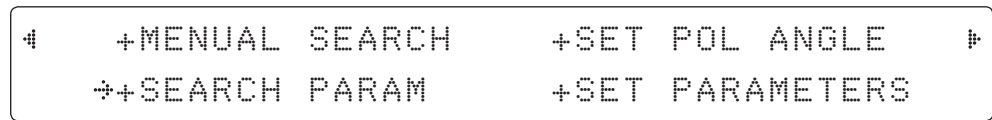

3. Press the DOWN arrow key to move cursor to SEARCH PARAM menu and press the OK key to enter **SEARCH PARAM** menu.

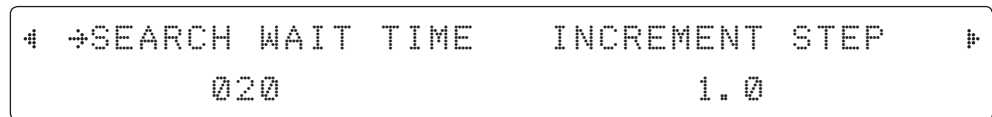

4. Press the LEFT and RIGHT arrow keys to select the parameter you wish to edit. Or, press the BACK key to return to the main display.

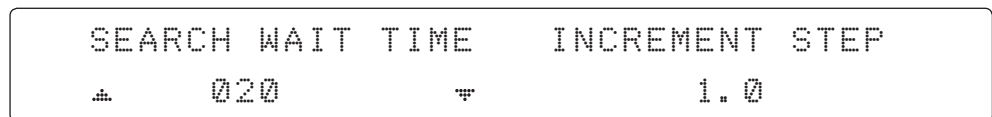

5. Set the **SEARCH WAIT TIME**. (Range: 20 - 120 sec)

Set the time-out for automatic initiation of a search after the signal level drops below threshold.

Press the LEFT and RIGHT arrow keys until the desired character is underscored (selected). Press the UP and DOWN arrow keys to increase and decrease the selected character or press the NUMBER keys to set the desired value directly.

Press the OK key to set the **SEARCH WAIT TIME**.

Press the BACK key to save or abort and return to the main display.

```

SEARCH WAIT TIME    INCREMENT STEP
      020           ▲          1.0          ▼
    
```

6. Set the **INCREMENT STEP** size.

Press the LEFT and RIGHT arrow keys until the desired character is underscored (selected). Press the UP and DOWN arrow keys to increase and decrease the selected character. Or, press NUMBER keys to set the desired value directly.

Press the OK keys to set the **INCREMENT STEP**.

Press the BACK key to save or abort and return to the main display.

```

┌ SEARCH1 AZ          SEARCH1 EL          ┐
└      016          12          ┘
    
```

7. Set SEARCH 1 and 3 AZ (Azimuth) range and EL (Elevation) range. SEARCH 2 is reserved for future use.

A search pattern 1 or 3 will be initiated according to which gyrocompass type is selected and the existence of the gyrocompass input.

Search 1: A search pattern 1 will automatically be initiated when the ship's heading input does not exist or has failed. The antenna will go to the relative azimuth position 0° at the calculated elevation and search in the azimuth CCW direction and search up +0.5° & down -0.5° with a total 6°(±3°) in elevation. The search cycle will repeat until the antenna receives the lock signal from the modem or the DVB transponder of the target satellite is decoded by the antenna. If the desired signal is found and above the predefined detect level, the ACU will enter to Search 3. However, the antenna will not initiate Search 3 pattern but go into TRACKING mode immediately if the desired signal is above the predefined tracking threshold level. If the detected signal is below the predefined tracking threshold level, the search 1 will repeat and start 3° away from the current position.

Search 1 (Gyro Free) Search Pattern

Target Satellite EL Position

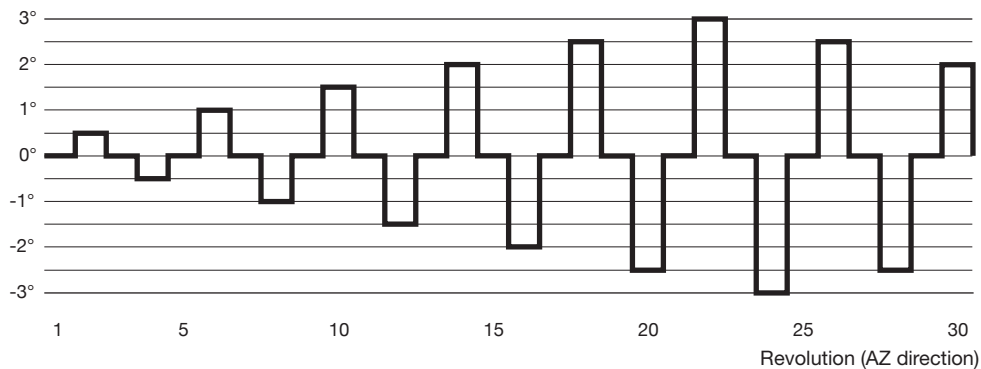

Search 1 antenna motion

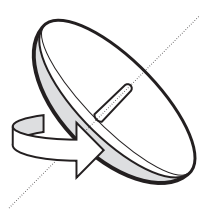

Target EL Angle 0°
Turn 1

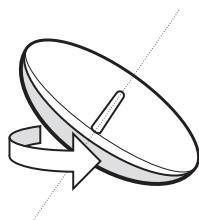

Target EL Angle + 0.5°
Turn 2

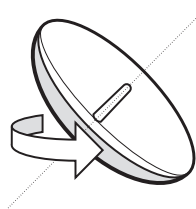

Target EL Angle 0°
Turn 3

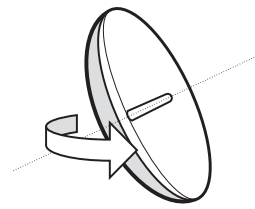

Target EL Angle - 0.5°
Turn 4

Search 3: Search 3: A search pattern 3 will automatically be initiated when AGC/SIG falls below the current tracking level threshold value. If the desired signal is found and above the predefined tracking level, the ACU will terminate Search 3 and go into TRACKING mode. A search pattern will automatically be initiated when AGC/SIG falls below the current threshold setting (indicates that satellite signal has been lost). Search is conducted in a two-axis pattern consisting of alternate movements in azimuth (AZ) and elevation (EL) as forming expanding square indicated as below diagram.

Search 3 pattern

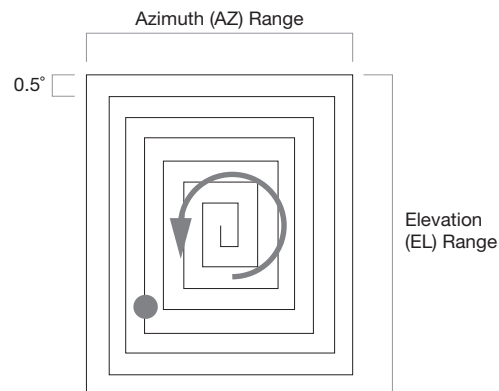

```
SEARCH1 AZ          SEARCH1 EL
  ▲    400          ▼           06
```

8. Set the **AZIMUTH RANGE**. (Range: 0 - 540)
Press the LEFT and RIGHT arrow keys until the desired character is underscored (selected). Press the UP and DOWN arrow keys to increase and decrease the selected character. Or, press NUMBER keys to set the desired value directly. Press OK key to set the new **AZ RANGE**.

```
SEARCH1 AZ          SEARCH1 EL
      400          ▲    06    ▼
```

9. Set the **ELEVATION RANGE**. (Range: 0 - 90)
Press the LEFT and RIGHT arrow keys until the desired character is underscored (selected). Press the UP and DOWN arrow keys to increase and decrease the selected character. Or, press NUMBER keys to set the desired value directly. Press OK key to set the new **EL RANGE**.

```
SEARCH3 AZ          SEARCH3 EL
  ▲    003          ▼           04
```

10. Press the OK key to set the Azimuth and Elevation ranges for SEARCH 3 in the same manner, then press the OK key.

```
                SAVE ?
  →YES                NO
```

11. Press the LEFT arrow key to move cursor to YES and press OK key to save and execute the current settings. Or, press the RIGHT arrow key to move cursor to NO and press OK key to abort and return to the main display.

Setting Antenna Parameters

```

                SETUP MODE ?
          +YES                      NO
    
```

1. Press the LEFT key to move cursor to YES and press the OK key to enter setup mode.

```

    ++ANTENNA                      +SATELLITE
      +SYSTEM                      +INSTALLATION
    
```

2. Press the OK key to enter **ANTENNA** menu.

```

    #  +MANUAL SEARCH              +SET POL ANGLE  #
      +SEARCH PARAM              ++SET PARAMETERS
    
```

3. Press the RIGHT arrow key to move cursor to **SET PARAMETERS** menu and press the OK key to enter **SET PARAMETER** menu.

```

                ENTER PASSWORD
                - - - -
    
```

4. Access to the password protected system. Setup parameters are only required after installation for repairs of your antenna system. These parameters should only be changed by an authorized service technician. Improper setting of these parameters will cause your system to perform improperly.

Press 4-digit password to enter **SET PARAMETERS** menu. (1590)

```

    #  ++DETECT LEVEL             TRACKING LEVEL  #
              060                     030
    
```

5. Press the LEFT and RIGHT arrow keys to select the parameter you wish to edit. Or, press the BACK key to return to the main display.

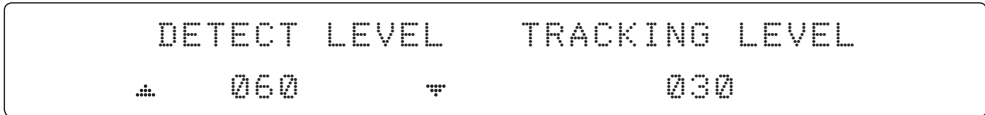

6. Set the **DETECT LEVEL**. (Range: 1-200) The detect level is to set the satellite signal detection level.

Press the LEFT and RIGHT arrow keys until the desired character is underscored (selected). Press the UP and DOWN arrow keys to increase and decrease the selected character. Or, press the NUMBER keys to set the new **DETEC LEVEL**. Or, press the return key to return to the main display.

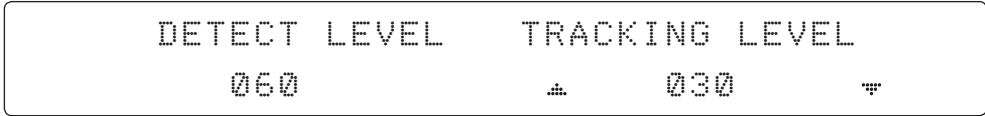
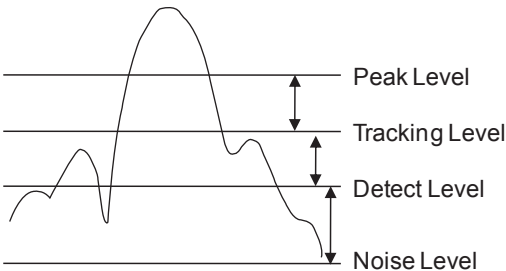

7. Set the **TRACKING LEVEL**. (Range: 1-200)
The tracking level is to set the satellite signal tracking level.

Press the LEFT and RIGHT arrow keys until the desired character is underscored (selected). Press the UP and DOWN arrow keys to increase and decrease the selected character. Or, press the NUMBER keys to set the desired value directly. Press the OK key to set the new **TRACKING LEVEL**.

BOW OFFSET	EL. ADJUST
▲ 000 ▼	+0.0

8. Set the **BOW OFFSET**. (Range: 0 -360)

The bow offset is to offset the angle difference between the antenna's bow and the ship's bow.

Press the LEFT and RIGHT arrow keys until the desired character is underscored (selected). Press the UP and DOWN arrow keys to increase and decrease the selected character. Or, press the NUMBER keys to set the desired value directly. Press the OK key to set the new **BOW OFFSET**.

BOW OFFSET	EL. ADJUST
000	▲ +0.0 ▼

9. Set the **EL ADJUST**. (Range: ± 5)

The elevation adjust is to offset the angle difference between the mechanical elevation angle and actual elevation angle.

Press the LEFT and RIGHT arrow keys until the desired character is underscored (selected). Press the UP and DOWN arrow keys to increase and decrease the selected character. Or, press the NUMBER keys to set the desired value directly. Press the OK key to set the new **EL ADJUST**.

```
VOLT THRES.      SCAN OFFSET
  ▲  0650  ▼           55
```

10. Set the **VOLT THRES.**
The voltage threshold is to distinguish the voltage between 13V and 18V.

Press the LEFT and RIGHT arrow keys until the desired character is underscored (selected). Press the UP and DOWN arrow keys to increase and decrease the selected character. Or, press the NUMBER keys to set the desired value directly. Press the OK key to set the new VOLT THRES.

```
VOLT THRES.      SCAN OFFSET
      0650           ▲  55  ▼
```

11. Set the **SCAN OFFSET.** (Range: 0 -90)

The scan offset is to offset the angle difference between the black marker on the sub-reflector and the optical sensor.
Press the LEFT and RIGHT arrow keys until the desired character is underscored (selected). Press the UP and DOWN arrow keys to increase and decrease the selected character. Or, press the NUMBER keys to set the desired value directly.
Press the OK key to set the new SCAN OFFSET.

```

      USE WRS           WRS DETECT LEVEL
      ▲   YES   ▼           0400
    
```

12. Set the **USE WRS**.

USE WRS is to determine whether the system uses WRS LEVEL or not. USE WRS and WRS LEVEL are pair functions.

Press the UP and DOWN arrow keys to select "YES" to USE WRS or "NO" to NOT USE WRS and press the OK key to set the **USE WRS**.

```

      USE WRS           WRS DETECT LEVEL
      YES           ▲   0400   ▼
    
```

13. Set the **WRS DETECT LEVEL** (Range: 10 - 5,000)

The WRS level is to set the WRS detection level.

Press the LEFT and RIGHT arrow keys until the desired character is underscored (selected). Press the UP and DOWN arrow keys to increase and decrease the selected character. Or, press the NUMBER keys to set the desired value directly. Press the OK key to set the new **WRS DETECT LEVEL**.

```

      USE OFFSET           OFFSET DIFF.
      ▲   YES   ▼           000
    
```

14. Set the **USE OFFSET**.

USE OFFSET is to determine whether the system uses OFFSET DIFF or not. USE OFFSET and OFFSET DIFF are pair functions.

Press the UP and DOWN arrow keys to select "YES" to USE OFFSET or "NO" to NOT USE OFFSET and press the OK key to set the **USE OFFSET**.

```

      USE OFFSET           OFFSET DIFF.
      YES           ▲   000   ▼
    
```

15. Set the **OFFSET DIFF.** (Range: ±100)

The offset difference is to offset the signal difference between RHCP and LHCP.

Press the LEFT and RIGHT arrow keys until the desired character is underscored (selected). Press the UP and DOWN arrow keys to increase and decrease the selected character. Or, press the NUMBER keys to set the desired value directly. Press the OK key to set the new **OFFSET DIFF.**



16. Select operation process.

Press the UP and DOWN arrow keys to select the command from **OPERATION***.

OPERATION*

- **SAVE:** save and execute the current settings.
- **REBOOT:** the antenna will restart automatically if REBOOT is selected.
- **RATESENSOR BIAS:** rate sensor bias is to calibrate DC voltage output from the three rate sensors used to sense antenna motion in azimuth, elevation and cross-level axes. The DC voltage output from each of the rate sensors may vary by an amount which is directly proportional to the direction and rate of motion induced on it. The motion of the ship must be stable when the sensor box is replaced.
- **TILT BIAS:** TILT BIAS is to adjust the two solid-state tilt sensors used to provide absolute cross-level tilt of the antenna and elevation feedback to eliminate long-term pointing drift (error). The TILT BIAS is required to be set when the system is newly installed or when the antenna control board or sensor box is replaced. Check and see if the bubble is located at the center of the level vial. If not, touch OK key to enter TILT BIAS menu to adjust it.

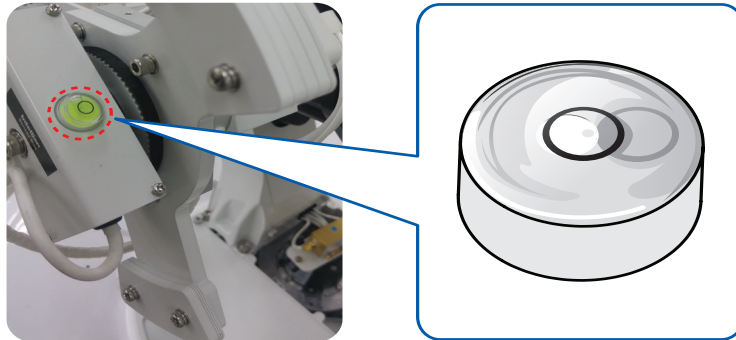

```

STEP SIZE      ELEVATION      CROSS LEVEL
#  0.2  #  ▲ 000.0  ▼  + 01.0  †
    
```

17. Press the NUMBER keys to set the step size.

Press the OK keys to select the parameter you wish to edit.

Press the LEFT and RIGHT arrow keys to move **CROSS LEVEL OFFSET** by step size. Press the UP and DOWN arrow keys to move **ELEVATION OFFSET** by step size.

```

                                SAVE ?
                                +YES      NO
    
```

18. Press the BACK key to save or abort and return to the main display.

```

DIAGNOSTIC      COMMUNICATION
▲  CODE 101    ▼  RESULT : PASSED
    
```

6. The diagnosis result is shown.

Diagnosis Code:

- CODE 101: The data communication between the antenna and the ACU is tested.
- CODE 102: The azimuth motor is tested.
- CODE 103: The elevation motor is tested.
- CODE 104: The cross-level motor is tested.
- CODE 105: The azimuth encoder is tested.
- CODE 106: The cross-level encoder is tested.
- CODE 107: The rate sensor is tested.
- CODE 108: The tilt sensor is tested.
- CODE 109: The sensor box motor is tested.
- CODE 110: The LNB is tested.
- CODE 111: The LNB skew motor is tested.
- CODE 112: The sub-reflector is tested. (Skip in the s100HD)
- CODE 113: The antenna power is tested.
- CODE 114: The ACU power is tested.
- CODE 115: The receiver power is tested.

Test Result: ● 2 ●● - ●●●●●●●●●●

●: passed the test, -: skipped the test, ?: is still under processing

Refer 2 to the diagnosis code 102 as shown above for occurred error explanation.

Satellite Settings

Setting the Satellite Pair

```

                SETUP MODE ?
          +YES                               NO
    
```

1. Press the LEFT arrow key to move cursor to YES and press the OK key to enter setup mode.

```

    +ANTENNA                               ++SATELLITE
    +SYSTEM                                 +INSTALLATION
    
```

2. Press the RIGHT arrow key to move cursor to **SATELLITE** and press the OK key to enter **SATELLITE** menu.

```

    ◀ ++SET SAT. PAIR                       +EDIT SATELLITE ▶
      +SET REGION                             +FIND TRANSPONDER
    
```

3. Press the OK key to enter **SET SAT. PAIR** menu.

```

                SET TRIPLE SAT ?
          +YES                               NO
    
```

4. Move cursor to YES and press the OK key to enter **Tri-Sat mode** or move cursor to NO and press the OK key to enter **Dual-Sat mode**.

```

    PRESET SLOT                             DEST. SATELLITE
    ▲ PRESET 1 ▼                             DTV101
    
```

5. Press the UP and DOWN arrow keys to select **PRESENT SLOT** 1, 2 and 3 in **Tri-Sat** mode or 1 and 2 in Dual-Sat mode.

```
PRESET SLOT      DEST. SATELLITE
PRESET 1         ↕   DTV101   ↕
```

6. Press the UP and DOWN arrow keys to select the **DESTINED SATELLITE** from the library (pre-programmed satellites). Press the OK key to set the **DESTINED SATELLITE**.

```
SAVE ?
↔YES          NO
```

7. Press the BACK key to save the current settings or abort and return to the main display.

Edit Satellite Information

```

                SETUP MODE ?
        +YES                                NO
    
```

1. Press the LEFT arrow key to move cursor to YES and press the OK key to enter setup mode.

```

        +ANTENNA                ++SATELLITE
        +SYSTEM                  +INSTALLATION
    
```

2. Press the RIGHT arrow key to move cursor to SATELLITE and press the OK key to enter **SATELLITE** menu.

```

    #   +SET SAT. PAIR   ++EDIT SATELLITE   #
        +SET REGION     +FIND TRANSPONDER
    
```

3. Press the RIGHT arrow key to move cursor to EDIT SATELLITE and press the OK key to enter **EDIT SATELLITE** menu.

```

                SELECT SATELLITE TO EDIT
                ▲      DTV101      ▼
    
```

4. Press the UP and DOWN arrow key to select the satellite that you wish to edit and press the OK key to edit the selected satellite.

```

    #   ++LONGITUDE                EDIT NAME   #
        101.0W                    DTV101
    
```

5. Press the RIGHT and LEFT arrow keys to select the parameter that you wish to edit.

Press the OK key to edit parameter.

Press the BACK key to save or abort and return to the main display.

LONGITUDE	EDIT NAME
▲ 101.0W ▼	DTV101

6. Set the **SATELLITE LONGITUDE**.

Press the LEFT and RIGHT arrow keys until the desired character is underscored (selected). Press the UP and DOWN arrow keys to increase or decrease the value. Or, press the NUMBER keys to set the desired value directly. Press the OK key to set the SATELLITE LONGITUDE.

LONGITUDE	EDIT NAME
101.0W	▲ DTV101 ▼

7. Set the **SATELLITE NAME**.

Press the LEFT and RIGHT arrow keys until the desired character is underscored (selected). Press the UP and DOWN arrow keys to increase or decrease the value. Or, press the NUMBER keys to set the desired value directly. Press the OK key to set the **SATELLITE NAME**.

VERIFY TYPE	VOLTAGE
▲ DVB DECODE ▼	AUTO

8. Set the satellite **VERIFICATION TYPE**.

Press the UP and DOWN arrow keys to select the Verification **Method*** while the antenna is tracking the satellite signal and press the OK key to set the **VERIFY TYPE**.

VERIFY TYPE	VOLTAGE
DVB DECODE	▲ AUTO ▼

9. Set the **LNB VOLTAGE**.

Press the UP and DOWN arrow keys to select the **LNB Voltage Supply Method*** and press the OK key to set the **VOLTAGE** ("AUTO" is recommended).



10. Set the **DISEQC**.

Press the UP and DOWN arrow keys to select **DiSEqC Method*** and press the OK key to set the DISEQC ("AUTO" is recommended).



11. Set the **POL TYPE** manually.

Press the UP and DOWN arrow keys to manually select LINEAR or CIRCULAR and press the OK key to set the **POL TYPE**.



12. Set **LOCAL FREQ.**

Press the UP and DOWN arrow keys to select the LNB local frequency from the installed LNB. Or, press the NUMBER keys to set the desired value directly. Press the OK key to set the parameter.

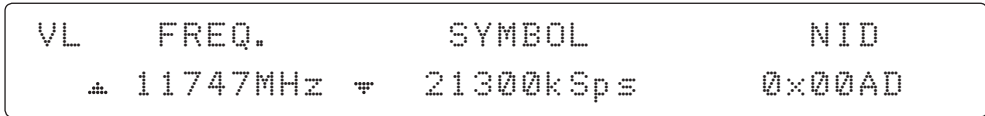

12-1. Set the satellite **FREQUENCY** for VL (Vertical/RHCP Low) band.

Press the LEFT and RIGHT arrow keys until the desired character is underscored (selected). Press the UP and DOWN arrow keys to increase or decrease the value. Or, press the NUMBER keys to set the desired value directly. Press the OK key to set the **FREQUENCY**.

VL	FREQ.	SYMBOL	NID
	12224MHz	▲ 20000kSpS ▼	0x00AD

12-2. Set the frequency **SYMBOL** rate (Maximum: 45,000). Press the LEFT and RIGHT arrow keys until the desired character is underscored (selected). Press the UP and DOWN arrow keys to increase or decrease the value. Or, press the NUMBER keys to set the desired value directly. Press the OK key to set the **SYMBOL**.

VL	FREQ.	SYMBOL	NID
	12224MHz	20000kSpS	▲0x00AD▼

12-3. Set the frequency NID (Network ID). Range is 0x0000-0xFFFF. Press the LEFT and RIGHT arrow keys until the desired character is underscored (selected). Press the UP and DOWN arrow keys to increase or decrease the value. Or, press the NUMBER keys to set the desired value directly. Press the OK key to set the **NID**.

HL	FREQ.	SYMBOL	NID
	▲ 12450MHz ▼	27490kSpS	0x00AD

13. Press the OK key to set the satellite frequency, symbol rate and NID for HL (Horizontal/LHCP Low) band in the same manner. Continue to press the OK key to set the satellite frequency, symbol rate and NID for VH (Vertical/RHCP High) and HH (Horizontal/LHCP High) in sequence.

Verification Method*

- AGC - use signal level for satellite tracking.
- DVB LOCK - use DVB Lock for satellite tracking.
- DVB DECODE - use DVB Decode for satellite tracking.
- DSS DECODE - use DSS Decode for satellite tracking.

Voltage Supply Method*

- AUTO - supply 13V or 18V to LNB.
- ONLY 13V - always supply 13V to LNB.
- ONLY 18V - always supply 18V to LNB.

DiSEqC Method*

- AUTO - supply 0KHz or 22KHz to LNB.
- ONLY 0KHz - always supply 0KHz to LNB.
- ONLY 22KHz - always supply 0KHz to LNB.

Setting the Region

```

                SETUP MODE ?
        +YES                                NO
    
```

1. Press the LEFT arrow key to move cursor to YES and press the OK key to enter setup mode.

```

        +ANTENNA                            ++SATELLITE
        +SYSTEM                              +INSTALLATION
    
```

2. Press the LEFT arrow key to move cursor to **SATELLITE** and press the OK key to enter **SATELLITE** menu.

```

#    +SET SAT. PAIR    +EDIT SATELLITE    #
    ++SET REGION      +FIND TRANSPONDER
    
```

3. Press the DOWN arrow key and the OK key to enter **SET REGION** menu.

```

    +SELECT CONTINENT    SELECT REGION
        N AMERICA        LOS_ANGELES
    
```

4. Press the arrow keys to select the parameter you wish to edit and press the OK key to edit parameter. Press the BACK key to save or abort and return to the main display.

```

        SELECT CONTINENT    SELECT REGION
    + N AMERICA             - LOS_ANGELES
    
```

5. Set the **CONTINENT**.

Press the UP and DOWN arrow keys to select the continent that you are in. Press the OK key to set the **CONTINENT**.

```

→SELECT CONTINENT      SELECT REGION
      N AMERICA        ←  LOS_ANGELES  ↓
    
```

6. Set the **REGION**.

Press the UP and DOWN arrow keys to select the region you are in.
Press the OK key to set the REGION.

```

                                LOAD ?
      →YES                                NO
    
```

7. Press the BACK key to load the current setting or abort and return to the main display.

```

LOADING . . .      ●●●○○○○○○○○○○○○○○○○○○
DO NOT TURN OFF !
    
```

8. Setting is being loaded to the system.

The ACU will restart the system automatically after uploading the setting.
DO NOT turn off ACU power while uploading is being processed.

```

← SEARCH      [↵] DTV101      #
                [2] DTV119
    
```

9. Region information has been updated.

Finding the Transponder

```
                SETUP MODE ?
          +YES                NO
```

1. Press the LEFT arrow key to move cursor to YES and press the OK key to enter setup mode.

```
+ANTENNA                ++SATELLITE
+SYSTEM                  +INSTALLATION
```

2. Press the RIGHT arrow key to move cursor to **SATELLITE** and press the OK key to enter **SATELLITE** menu.

```
+SET SAT. PAIR          +EDIT SATELLITE
+SET REGION              ++FIND TRANSPONDER
```

3. Press the DOWN arrow key and the OK key to enter **FIND TRANSPONDER** menu.

```
                BAND                FREQ.                SYMBOL
▲ VER LOW ▼      12224MHz          20000kSp s
```

4. Press the UP and DOWN arrow keys to select the frequency band you wish you edit.

Press the OK key to edit the selected frequency.

```

      BAND          FREQ.          SYMBOL
VER LOW    ▲ 12224MHz ▼  20000kSpS
    
```

5. Set the satellite **FREQUENCY**.

Press the LEFT and RIGHT arrow keys until the desired character is underscored (selected). Press the UP and DOWN arrow keys to increase or decrease the value. Or, press the NUMBER keys to set the desired value directly.

Press the OK key to set the **FREQUENCY**.

```

      BAND          FREQ.          SYMBOL
VER LOW    12224MHz  ▲ 20000kSpS ▼
    
```

6. Set the frequency **SYMBOL RATE**.

Press the LEFT and RIGHT arrow keys until the desired character is underscored (selected). Press the UP and DOWN arrow keys to increase or decrease the value. Or, press the NUMBER keys to the desired value directly.

Press the OK key to set the **SYMBOL**.

```

◀ [CHECK NID]  F: 12224  S: 27490xFFF0 ▶
      PRESS OK      RECEIVED NID [0x0000]
    
```

7. CHECK NID is to verify the NID (Network ID) of the current tracking transponder.

Press the OK key to verify the NID [0 x 0000] only when "PRESS OK" function is activated. "PRESS OK" function will only be activated when DVB Lock signal is confirmed by the antenna. However, "NO LOCK" message will be displayed if DVB Lock signal can't be confirmed.

8. Press BACK key to return to the main display.

System Settings

Setting the GPS and Gyrocompass

```

                SETUP MODE ?
          +YES                               NO
    
```

1. Press the LEFT arrow key to move cursor to YES and press the OK key to enter setup mode.

```

          +ANTENNA                          +SATELLITE
        ++SYSTEM                            +INSTALLATION
    
```

2. Press the DOWN arrow key to move cursor to SYSTEM and press the OK key to enter **SYSTEM** menu.

```

  #  ++SET LOCATION      +MANAGEMENT      #
        +KEY LOCK
    
```

3. Press the RIGHT arrow key to move cursor to SET LOCATION and press the OK key to enter SET **LOCATION** menu

```

          GYRO TYPE                          BAUDRATE
        ^  NMEA  v                          4800
    
```

4. Set the ship's GYRO TYPE* and BAUD RATE

A search pattern 1 or 3 will be initiated according to which GYRO TYPE is selected and the existence of the gyrocompass input. Set the BAUD RATE as 4800, 9600, 19200 or 38400 according to device options.

A search pattern 1 will be initiated automatically if the gyrocompass input does not exist and the gyrocompass type is selected other than GROUND TEST.

NOTE: The bow offset is not saved or used if GYRO TYPE is set to NONE. Search 1 will initiate each time antenna re target or during restart/initialization. It is recommended a GYRO is used for efficient target calculation and reduced search time.

Setting of Heading Device			
Existence of Heading Data	None	NMEA / NMEA 2000	Ground Test
With Heading Data	Search 1	Search 3	Search 3
Without Heading Data	Search 1	Search 1	Search 3

GYRO TYPE*
 NO DEVICE
 NMEA
 NMEA 2000
 GROUND TEST

```

┌  ++LATITUDE      +LONGTITUDE  ┐
│          37.07N          127.05E  │
└──────────────────────────────────┘
  
```

5. Press the LEFT AND RIGHT arrow keys to select the parameter to edit. Or, press the BACK key to return to the main display.

```

┌  LATITUDE      LONGITUDE  ┐
│  37.07N      127.05E  ┆
└──────────────────────────┘
  
```

6. Set the current **LATITUDE**.

Press the LEFT and RIGHT arrow keys until the desired character is underscored (selected). Press the UP and DOWN arrow keys to increase or decrease the value. Or, press the NUMBER keys to set the desired value directly.

Press the OK key to set the **LATITUDE**.

```

┌  LATITUDE      LONGITUDE  ┐
│  37.07N      127.05E  ┆
└──────────────────────────┘
  
```

7. Set the current **LONGITUDE**.

Press the LEFT and RIGHT arrow keys until the desired character is underscored (selected). Press the UP and DOWN arrow keys to increase or decrease the value. Or, press the NUMBER keys to set the desired value directly.

Press the OK key to set the **LONGITUDE**.

8. Set the ship's current **HEADING**.

HEADING
± 000.0 ▾

Entry of ships heading is not required when your system is connected to a NMEA0813 Heading Gyrocompass output.

Press the LEFT and RIGHT arrow keys until the desired character is underscored (selected). Press the UP and DOWN arrow keys to increase or decrease the value. Or, press the NUMBER keys to set the desired value directly. Press the OK key to set the **HEADING**.

SAVE ?
→YES NO

9. Press the LEFT arrow keys to move cursor to YES and press the OK key to save current setting. Or move cursor to NO and press the OK key to return to the main display.

System Management

```

                SETUP MODE ?
          +YES                               NO
    
```

1. Press the LEFT arrow key to move cursor to YES and press the OK key to enter setup mode.

```

          +ANTENNA                          +SATELLITE
        ++SYSTEM                            +INSTALLATION
    
```

2. Press the DOWN arrow key to move cursor to SYSTEM and press the OK key to enter **SYSTEM** menu.

```

#    +SET LOCATION    ++MANAGEMENT    #
      +KEY LOCK
    
```

3. Press the ARROW key to move cursor to MANAGEMENT and press the OK key to enter **MANAGEMENT** menu.

```

                SELECT PROCESS TYPE
          ▲          BACKUP USER DATA          ▼
    
```

4. Press the UP and DOWN arrow keys to **SELECT PROCESS TYPE***. Press the OK key to set the parameter and the processing message will be displayed.

```

                BACKUP ANTENNA PARAMETERS ?
          +YES                               NO
    
```

5. Press the LEFT and RIGHT arrow keys to select YES or NO to process selected process type.

```

    BACKUP AND INFO
    DO NOT TURN OFF ! ●●●○○○○○○○○○○○○○○○○○○○○
    
```

6. Processing message is displayed.

SELECT PROCESS TYPE*

BACKUP USER DATA: To backup the antenna settings set by user to the ACU.

RESTORE USER DATA: To restore the antenna by using the backup user data stored from the ACU.

DEFAULT ACU-REMOTE P/W: to default ID and Password of the Web Server.

UPGRADE FROM USB: to upgrade the system by using the firmware files from a specified folder in the USB flash drive.

COPY LOG TO USB: to copy the antenna log data from the system to the USB flash drive.

BACKUP TO USB: To backup the antenna settings to a specified folder in the USB flash drive.

RESTORE FROM USB: To restore the antenna by using the backup user data from a specified folder in the USB flash drive.

UPGRADE ACU-REMOTE: To upgrade the system using the Aptus Web firmware file from a specified folder in the USB flash drive.

NOTE: UPGRADE FROM USB, COPY LOG TO USB, BACKUP TO USB, RESTORE FROM USB and UPGRADE ACU-REMOTE options are displayed only if the USB flash drive is plugged into the USB port located on the front panel of the ACU.

Key Lock / Password Management

```

                SETUP MODE ?
          +YES                               NO
    
```

1. Press the LEFT arrow key to move cursor to YES and press the OK key to enter SETUP mode.

```

          +ANTENNA                          +SATELLITE
        ++SYSTEM                            +INSTALLATION
    
```

2. Press the DOWN arrow key to move cursor to SYSTEM and press the OK key to enter SYSTEM menu.

```

#   +SET LOCATION                          +MANAGEMENT   #
        ++KEY LOCK
    
```

3. Press the RIGHT arrow key to move cursor to KEY LOCK and press the OK key to enter KEY LOCK menu.

```

                KEY LOCK
          ▲ OFF ▼
    
```

4. Press the UP and DOWN arrow keys to choose whether or not to use key pad lock when entering the SETUP mode or saving the satellite information.

```

                KEY LOCK                      UNLOCK P/W
                  ON                          ▲ 1590 ▼
    
```

5. Setup the password for entering the key pad lock. The factory default is 1590.

```

# TRACKING DTV101                AGC: 501    [V L] #
 *AZ: 292.7 ( 202.7) EL: 48.3 SK: ▲-72.0▼ Fn
    
```

When KEY LOCK function is activated, the " # " mark is displayed.

Introduction

Requirements

Software Installation

PC to ACU Communication Setup

Starting Aptus®

Establish a data communication

AutoUpdate

Toolbar Menus

System Property Status Dashboard

Work View Tabs

1. Antenna – Basic Info.
2. Antenna – Advanced Info.
3. Satellite (Satellite View)
4. Graph View
5. Monitor
6. ACU System
7. Work View Functions

Introduction

Intellian's Antenna PC Controller Software, Aptus® is a next-generation graphically based antenna remote control software. Aptus® allows users to easily and conveniently set up the antenna by using a personal computer.

The minimum PC hardware and software requirements to install and run Aptus® are as below.

Requirements

Hardware

Hardware	Requirements
CPU	Intel® Pentium® 4 or higher
Memory	512MB or higher
Video Card	DirectX9.0 or higher supported
	H/W acceleration supported
	Video Memory 128MB or higher
HDD	1GB or higher

Operating System and Software

Software	Requirements
Operating System	Windows XP SP or higher
Framework	Microsoft.Net Framework 3.5 Service Pack 1 or higher

Software Installation

Double click the 'Aptus Setup.exe' icon  to install Aptus® directly onto your computer/ laptop. The InstallShield Wizard will guide you through the program setup process. The installation routine provides an icon on the desktop.

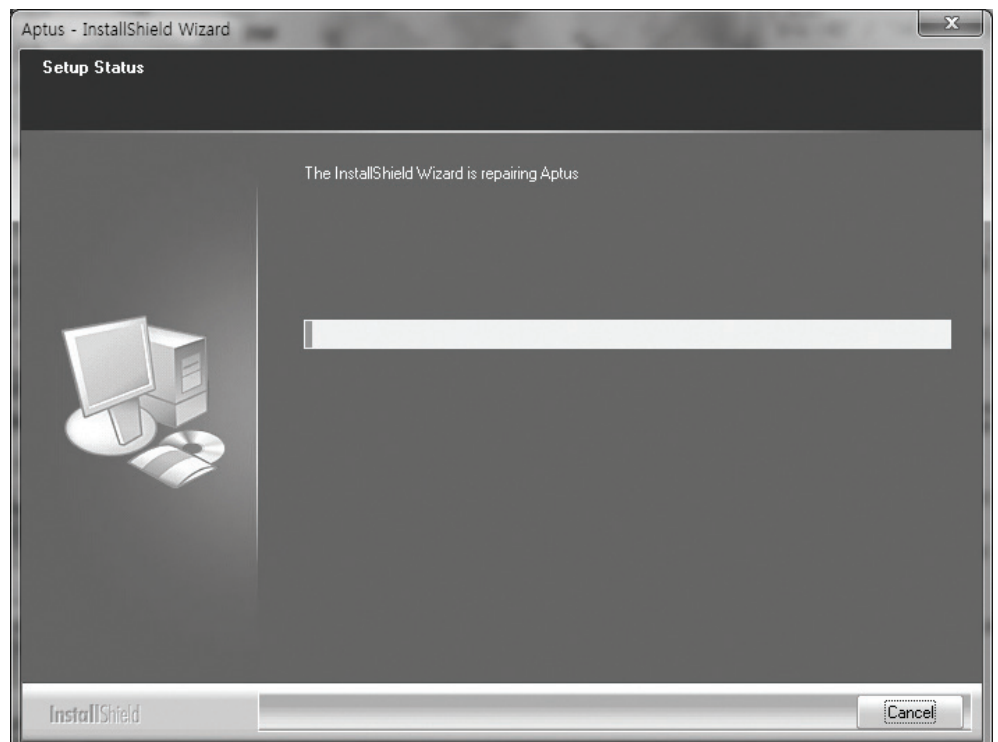

Click the icon to start the software. In addition, Intellian also provides patch files for software upgrade.

PC to ACU Communication Setup

Starting Aptus®

Double-click the Aptus® desktop icon to open a Communication Window to establish the data communication between your PC and the ACU. Select which method to connect to your ACU, either through the Serial Port Communication or the Network Communication (TCP/IP).

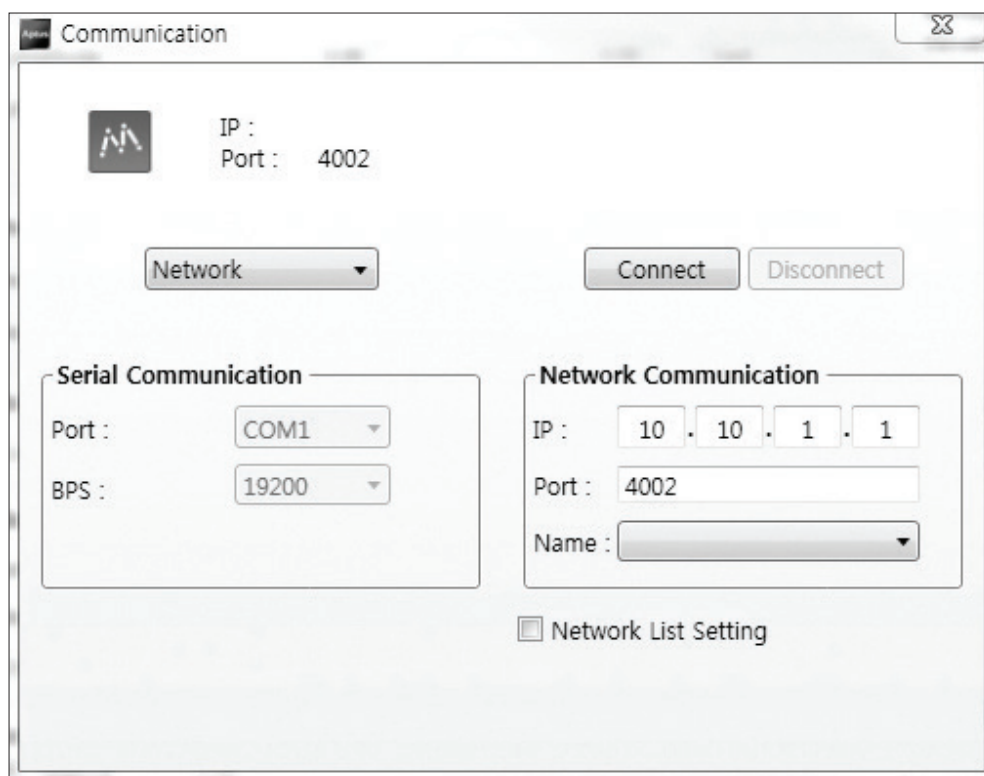

Establish a data communication

Access ACU through Serial Communication

1. Connect a 9 pin Serial cable between the PC INTERFACE connector on the ACU and the 9 pin Serial port on the PC. (Or use a USB cable to setup Serial connection between a PC and the USB port on the ACU.)
2. Select Serial at communication type combo-box.
3. The baud rate of the ACU is 57600.
4. Select a COM port which is not occupied by other devices.
5. Click the Connect button.

Access ACU through Network Communication (TCP/IP)

1. Connect the PC to the Management Port.
2. Select Network at communication type combo-box.
3. Enter in the ACU's IP address (Factory default: 192.168.2.1)
4. Enter in the ACU's port number (Factory default: 4002)
5. Click the Connect button then the Authentication window will appear.
6. Login by using the username and password below:
 - Username: intellian (Factory default)
 - Password: 12345678 (Factory default)

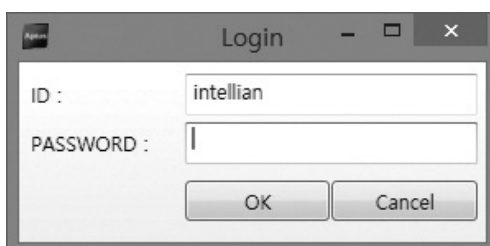

NOTE: If the remote access PC is located in the same network group with the ACU, the ACU can be accessed through the internal IP address. But, if the remote access PC is located outside of the network group, the ACU's IP address should be changed to the IP address assigned by the network service provider.



WARNING

WARNING:

- Do not plug a USB to the ACU while TCP/IP communication is in use. Doing so will disable current PC Software Control because the USB connection has higher priority than TCP/IP connection.
- The amount of data will increase rapidly if Network Communication is in use. Intellian recommends using Aptus Web to access the ACU.

AutoUpdate

Intellian Aptus® checks and notifies the latest version when it is started to maintain up to date software version by its AutoUpdate function.

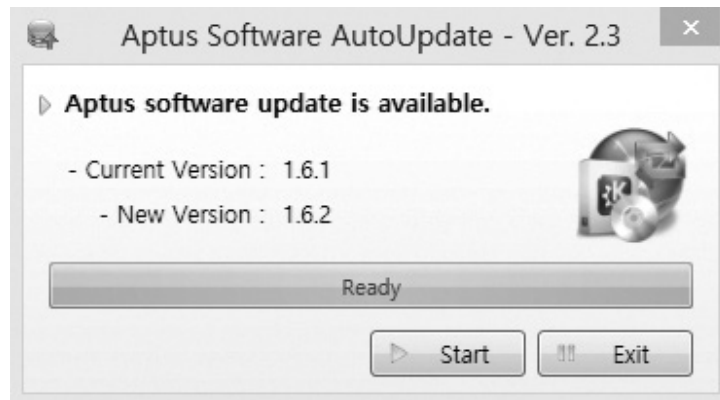

1. When Aptus® is started, it automatically checks the latest software version from the server and runs AutoUpdate which will display the current software version and if a new version is available.
2. When a new software version is available, click the "Start" button and "File downloading..." message will be displayed while the files are downloaded from the server. When file downloading is finished, "installing..." message is displayed and Aptus patch runs and the installation starts by InstallShield.

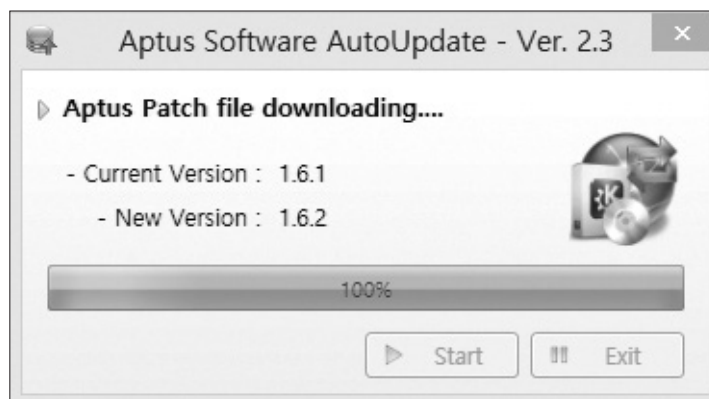

3. Click the "Finish" button when InstallShield installation is finished, then "Run the Aptus" message is displayed and Aptus runs and AutoUpdate is automatically finished.

Toolbar Menus

The toolbar menus at the top of the screen display command buttons of the most commonly used functions of the Aptus®. The toolbar menu consists of 6 main menus; Quick (for quick launch of functions), File (for file backup, restoring and loading), View (for user layout and work view), Connection (for communication), Util (for upgrade, firmware updates, and utility) and Setting & Help (for setting, reporting problems and information check).

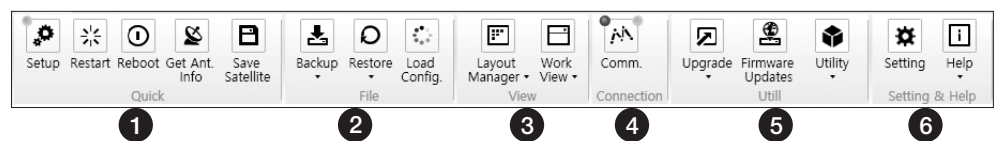

① Quick



Setup: enters Setup mode.



Restart: exits Setup mode and restarts the antenna.



Reboot: reboots the antenna.



Get Ant. Info: obtains the information stored in the antenna.



Save Satellite: saves the current bow offset only if the antenna is tracking onto the satellite. The satellite acquisition time can be reduced significantly after the antenna is restarted.

② File

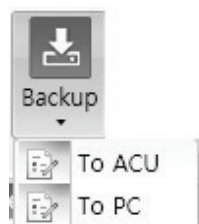

Backup: backs up the antenna information to ACU or PC.

- Select 'To ACU' to backup the antenna information to ACU. The backup file (file format: *.ibf) will be stored on the ACU.
- Select 'To PC' to backup the antenna information to a PC. The backup files (file format: *.rpt and *.ibf) will be generated on the PC.

NOTE: Both *.rpt and *.ibf files contain antenna information. However, while *.ibf file can be used for restoring antenna information, *.rpt file is stored as plain-text for viewing purpose only. Users can open the *.rpt using text editors such as notepad software.

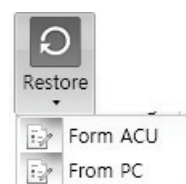

Restore: restores the antenna by using the stored information in ACU or PC.

- Select 'From ACU' to restore the antenna by using the stored information in ACU.
- Select 'From PC' to restore the antenna by using the stored information in PC (file format: *.ibf).



Load Config.: loads the antenna configuration file (file format: *.cfg).
 The configuration file includes the antenna control parameters which are preloaded at the factory and should only be changed by an authorized service technician. Improper setting of these parameters will cause the system to perform improperly.

③ View

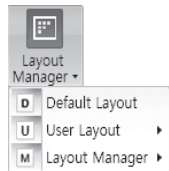

- **Default Layout:** returns the current layout to the default layout.

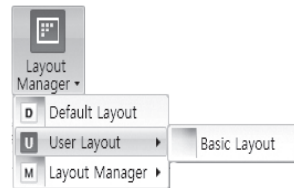

- **User Layout:** displays the layout list that the user has previously stored by using Layout Manager. By selecting a layout in the list it will be constructed in the Work View screen. The 'Basic layout' is provided by default.

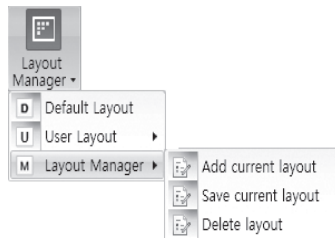

- **Layout Manager:** provides the user with add, delete, and save functionalities in order to manage the user's layouts.
 - Selecting 'Add current layout' opens a pop up window. Type in a desired name of current layout and click Add, then the new name of the current layout will be saved to the list under User Layout menu.
 - When changes are made to the current layout, select 'Save current layout' option. The current layout will be saved with changes.
 - To remove a layout, select 'Delete layout' option. Select a desired layout to remove on the pop up window, then click 'Delete'. Close the window by clicking on 'Close'. The selected layout is removed from the User Layout list.
-

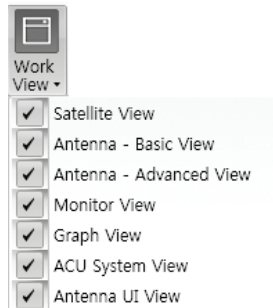

- **Work View:** displays a list of seven pre-constructed Work View Tabs (Satellite View, Antenna Basic View, Antenna Advanced View, Monitor View, Graph View, ACU System View, and Antenna UI View) and also provides the Activate / Close functionalities for each view tab. Activate the work view tab by ticking the checkbox next to it.

④ Connection

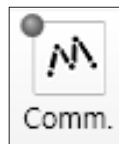

At any time, data communication channel can be re-established between Serial and Network connection. Selecting Comm. Button will display the Communication Window to connect to the ACU via Serial or Network communication.

⑤ Util



- **Firmware Uploader:** Upload the firmware of antenna and ACU. Ensure the USB cable is connected between the 'USB port' on the PC to the 'PC port' on the ACU.
- **iARM Upgrade:** Upgrade the firmware of iARM module.

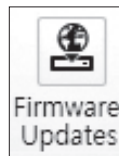

Firmware Updates: provides the user with the latest firmware version and updates firmware by simple steps.

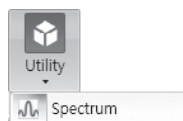

- **Spectrum:** displays current spectrum graph and allows to set spectrum data view options.

⑥ Setting & Help



- **Auto Update:** When Aptus PC has started, you can turn auto update on or off. If you click the auto update check button, Aptus PC will check and update, if there is a new version available for download on the server.
- **Network Communication:** Set up the timeout to display the message box which appears when the TCP is not connected to the antenna.

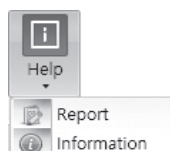

- **Report:** provides e-mail contact to Intellian technical support team to let the user report problems at any time.
- **Information:** displays the information of current Aptus® software version.

System Property Status Dashboard

The property status dashboard on the left pane of the screen provides the antenna status, diagnostic error report, tracking satellite, signal level, GPS, heading, time, date status, voltage, software information and product information to be monitored quickly.

The screenshot displays the System Property Status Dashboard with the following sections:

- 1 Antenna Status:** Search 3. Includes buttons for Initialize, Search 3, and Tracking.
- 2 Diagnostic Error Report:** A checkbox that is currently unchecked.
- 3 Tracking Satellite:** Three radio buttons for JCSAT_3 (A), JCSAT_3 (B), and KOREA_6 (C). The first JCSAT_3 option is selected.
- 4 Signal Level:** 231. A progress bar shows a value of 23. Local Frequency: 10600 MHz.
- 5 GPS:** 127.05 E 37.07 N. Heading: 0.00. Time: 04:16:09 (UTC). Date: 2016-10-31.
- 6 Voltage:** Antenna: 25.2V, ACU: 27.9V.
- 7 Software Information:** Ant. PCU: V 2.00, Ant. Stabilizer: V 2.00, ACU Main: V 2.00, Lib Version: V 0.90.
- 8 Product Information:** System Model: S100HD, Ant. Name: T3-S100T, Ant. Serial: T3-3221S1, ACU Serial: T1116056033.

- ① Antenna Status: Displays the status of the current mode of the antenna.
- **Search 1:** A Search 1 pattern will automatically be initiated when the ship's heading input does not exist or if it fails. The search cycle will repeat until the antenna receives the lock signal from the receiver or until the DVB transponder of the target satellite is decoded by the antenna.
 - **Search 2:** Search 2 is reserved for future use.

- **Search 3:** Search 3 pattern will automatically be initiated when AGC falls below the current tracking level threshold value. Once the desired signal is found and above the predefined tracking threshold, the ACU will enter to tracking mode.
- **Tracking:** Antenna is tracking the target satellite.
- **Initialize:** Antenna or ACU is initializing.
- **Setup:** Antenna is in SETUP mode.

② Diagnostic Error Report

The square button next to the Diagnostic Error Report turns red when the system receives an error. Click the button to see a Diagnostic Report.

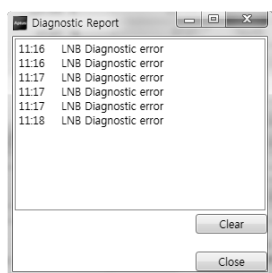

③ Tracking Satellite

Display or set current tracking satellite and tracking information. Up to three satellites can be selected.

④ Signal Level

Shows "DVB" when DVB mode of tracking signal is in use. The "Red" line indicates the signal "Detect Level Threshold" and the "Orange" line indicates the signal "Tracking Level Threshold". If the signal level is higher than the tracking level threshold, the signal level bar will display "Blue" color. If the signal level is lower than the tracking level threshold, the signal level bar will display "Orange" color and the antenna will stay in searching mode.

NOTE: If the signal level is not higher than the tracking threshold, decrease the detect and tracking level.

⑤ GPS, Heading, Time and Date

Displays the current GPS location from the Antenna and Ship's heading information. The status light flashes green if the system receives a correct input of the GPS and Ship's heading. Display the current UTC Time and Date.

GPS	●	127.05 E	37.07 N
Heading	●	0.00	
Time		04:16:09 (UTC)	
Date		2016-10-31	

⑥ Voltage: Displays the antenna and the ACU voltage information.

Voltage ^	
Antenna :	25.2V
ACU :	27.9V

⑦ Software Information: Displays the antenna and the ACU firmware versions, and the library version.

Software Information ^	
Ant. PCU :	V 2.00
Ant. Stabilizer :	V 2.00
ACU Main :	V 2.00
Lib Version :	V 0.90

⑧ Product Information: Displays the antenna and ACU serial numbers, antenna model and ACU model.

Work View Tabs

Aptus® provides seven Work View Tabs (Antenna Basic View, Antenna Advanced View, Satellite View, Graph View, Monitor View, Diagnostic View, and GUI View) to manage the Antenna and the Satellite configuration.

How to modify the settings on Work View;



1. Enter the Setup mode by clicking Setup icon.

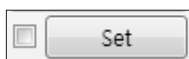

2. Tick the checkbox next to the "Set" button to modify the settings.
3. Enter the desired value then press the Set button to save the settings.

1. Antenna – Basic Info.

This view tab provides information on the Antenna's Current GPS location, Heading Device, Bow Information, Skew Information, and the Antenna's Angle. This view tab uses the Antenna's AZ and EL information as well as the Ship's Heading information in order to provide a dynamic graphic user interface (UI).

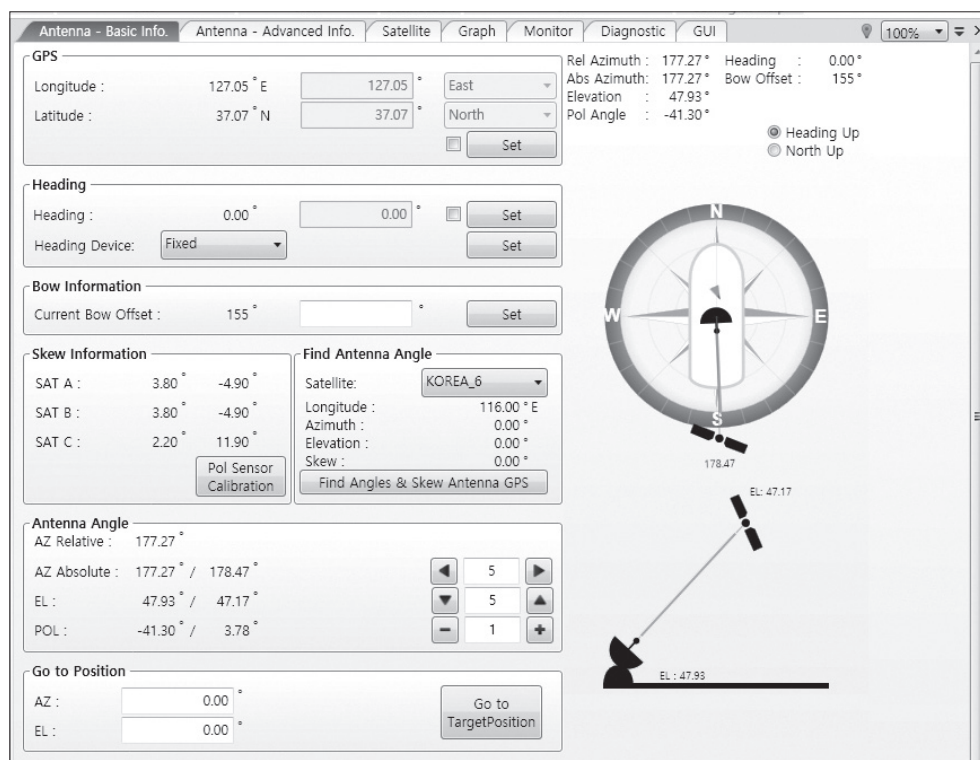

- **GPS:** displays and sets current antenna's GPS.

- **Heading:** displays and sets current ship's heading information.
 - Heading Device: None / NMEA/ NMEA 2000/Ground Test. The baud rate (4800/ 9600/ 19200/ 38400) must be set if NMEA is selected.

- **Bow Information:** displays and sets current antenna's bow.

- **Skew:** displays current antenna's skew and skew offset for the selected satellites.
 - Pol Sensor Calibration: calibrates the sensor (potentiometer).

- **Find Antenna Angle:** displays and sets the current antenna angle. Select a desired satellite from the drop-down menu, then longitude, azimuth, elevation and skew information are displayed.
 - Find Angles & Skew Antenna GPS: Finds the current antenna angles and skew angle in relation to the longitude (orbit position) of the antenna's current GPS.

- **Antenna Angle:** displays and sets current antenna absolute/relative AZ (azimuth) position, EL (elevation) position and POL (skew polarizer) position. The antenna azimuth, elevation or LNB Skew Pol positions can be moved using the arrow soft keys or inputting a value to move to a desired position.

- **Go to Position:** The current position (angle) of the antenna is displayed. Push the "Go to target Position" button after keying in the desired angle to move the antenna to target position.

2. Antenna – Advanced Info.

This view provides information on the Tilt Sensor Bias, Rate Sensor Bias, Conical Range, Parameter Setting, Threshold Setting and Search Parameter.

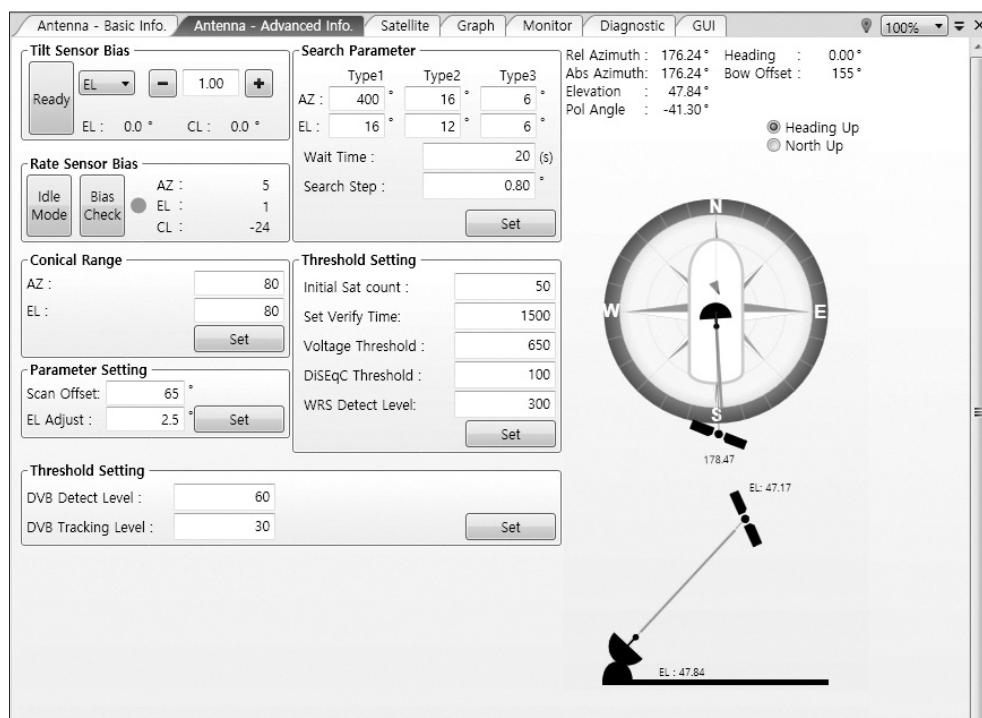

- **Tilt Sensor Bias:** This maintains the elevation and the cross level axes in order to keep the pedestal parallel to the horizon. Adjust the two solid-state tilt sensors to provide absolute cross-level tilt of the antenna and elevation feedback to eliminate long-term pointing drift (error). Tilt bias must be adjusted when the antenna control board or sensor box is replaced. If the bubble on the button level located on the sensor box is not centered, follow the steps below to adjust the tilt sensor bias.
 - Step 1. Enter Setup mode and press the "Ready" button to bring the elevation and cross-level to 0.
 - Step 2. Select "EL" from the drop down list and press Up and Down arrow keys to adjust the bubble until it is located in the center ring of the button level.
 - Step 3. Select "CL" from the drop down list and press Up and Down arrow keys to adjust the bubble until it is located in the center ring of the button level.
 - Step 4. Press the "Restart" icon to restart the antenna.

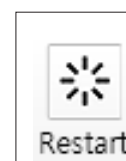

- **Rate Sensor:** is used to calibrate the DC voltage output from the three rate sensors (azimuth, elevation, and cross-level). These are used to sense antenna motion that corresponds to the ship's motion (roll, pitch, and yaw) for stabilizing the pedestal. The DC voltage output from each of the rate sensors may vary by an amount which is directly proportional to the direction and rate of motion induced on it.

Before calibrating the rate sensors located in the Sensor box, make sure that the antenna is placed on a rigid and flat platform. During the calibration process, any motion of the antenna should be avoided as it can affect the antenna's performance. Proceed with the following steps to perform the calibration.

- Step 1. Enter Setup mode
 - Step 2. Press the "Idle Mode" button to release the elevation and cross level motor brakes while the antenna is in Setup mode.
 - Step 3. Check whether or not the bubble is located at the center of the button level. If not, move it to the center by following the previous instruction of Tilt Sensor Bias adjustment.
 - Step 4. Press the "Bias Check" button to calibrate the rate sensor. A blue circle will be displayed next to the Bias Check button if the calibration is completed. A red circle will be displayed if calibration failed. A green circle will be displayed during the calibration process.
- **Conical Range:** The relative force of the motors controlling azimuth and elevation. Set the conical range while the antenna is in tracking mode.
 - **Parameter Setting:** used to set the control parameter settings.
 - Scan Offset: The scan offset is to offset the angle difference between the black marker on the sub-reflector and the optical sensor
 - EL Adjust: The elevation adjustment is to offset the angle difference between the mechanical elevation angle and actual elevation angle.

- **Search Parameter:**
 - Wait time: set the time-out for automatic initiation of a search after the signal level drops below the pre-defined threshold value.
 - Search Step: set incremental step size.
 - Type 1 & Type 3 (Search 1 & 3) Range: set Search 1 & 3 search range. Search 3 is conducted in a two-axis pattern consisting of alternate movements in azimuth and elevation as it forms an expanding square.
 - Type 2 (Search 2) Range: is reserved for future use.

- **Threshold Settings:** set the threshold level for detecting and tracking the satellite signal.
 - Initial Sat Count: Set the threshold count for maintaining tracking.
 - WRS Detect Level: Set the WRS detection level.
 - Voltage Threshold: Set the voltage threshold. The voltage threshold is to distinguish the voltage between 13V and 18V.
 - DiSEqC Threshold: Set the DiSEqC threshold. The DiSEqC threshold is to distinguish the 0KHz tone and 22KHz tone.
 - WRS Detect Level: Set the WRS detection level.
 - DVB Detect Level: displays and sets signal detection threshold level when DVB tracking mode is in use.
 - DVB Tracking Level: displays and sets signal tracking threshold level when DVB tracking mode is in use.

3. Satellite (Satellite View)

The name, longitude, Polarity, verification method of the satellite and local frequency are displayed. Click the "Edit Satellite Information" button to edit the satellite information. After modifying the value.

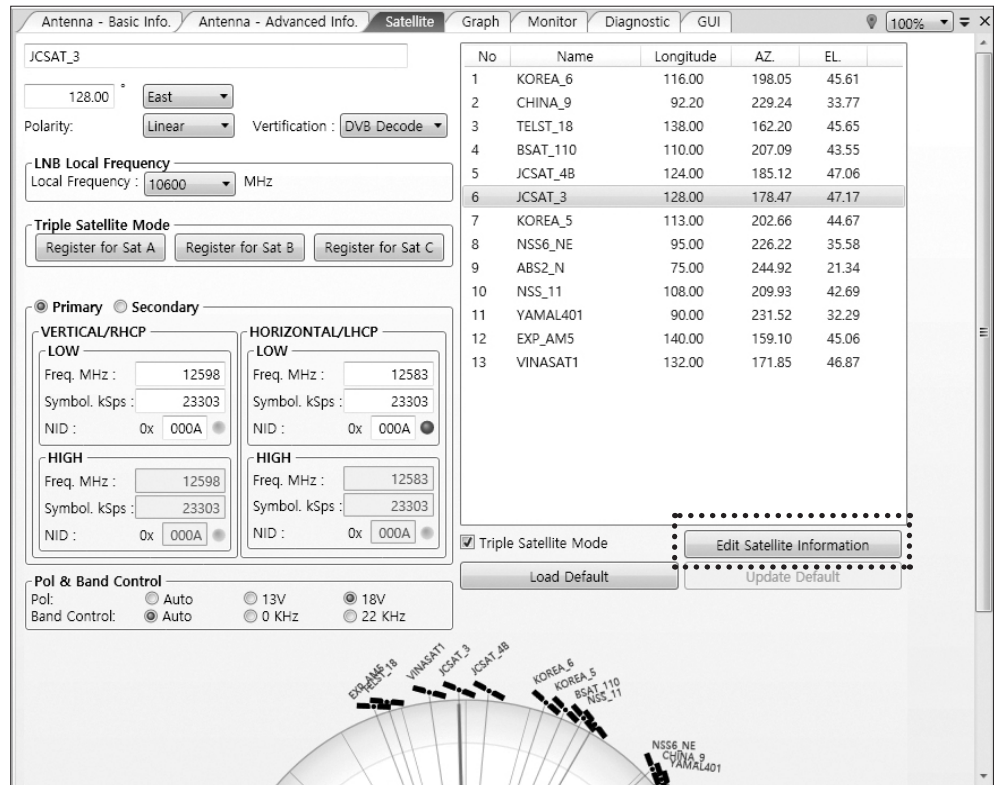

- **LNB Local Frequency:** Displays or sets LNB local frequency and its corresponding LNB voltage supplied. You may select pre-programmed LNB LO settings from the drop down list. This procedure is same for both the Intellian Global VSAT PLL LNB and any other LNB.
- **Transponder Information**
 - Register for Sat A & Register for Sat B & Register for Sat C: register the selected satellite for A, B or C.
 - Transponder information consists of frequency, symbol and NID (Network ID) of a transponder in tracking the satellite. There are four groups of transponder information. 'Vertical/RHCP' is applied when the IRD supplies 13V, and 'Horizontal/LHCP' is applied when the IRD supplies 18V. 'LOW' is applied when DiSeqC signal is not detected from IRD. 'HIGH' is applied when the DiSeqC signal is detected from the IRD. After modifying information, press the 'Edit Satellite Information' button, then new information is updated in the antenna.

- **Pol & Band Control:** The "Pol" controls 13V (Vertical/RHCP band) or 18V (Horizontal/ LHCP band). The "Band" controls DiSEqC 0KHz tone (Low band) and 22KHz tone (High band). After modifying information, press 'Edit Satellite Information' button, then new information is updated in the antenna.
- **Triple Satellite Mode:** To select between Dual-Sat mode and Triple-Sat mode, tick the 'Dual Satellite Mode' box or 'Triple Satellite Mode' box at the bottom of the screen.
- **Edit Satellite Information:** push the "Edit Satellite Information" button to update the information after modifying values.
- **Load Default:** Push the "Load Default" button to select a regional library file *.rif according to your region.
- **Update Default:** After loading a regional library file *.rif, push the "Update Default" button to update the system.

4. Graph View

This view provides information on Signal, Elevation (EL), Absolute AZ (Azimuth), Heading, Relative AZ, AZ and EL in Single or Multi graph formats.

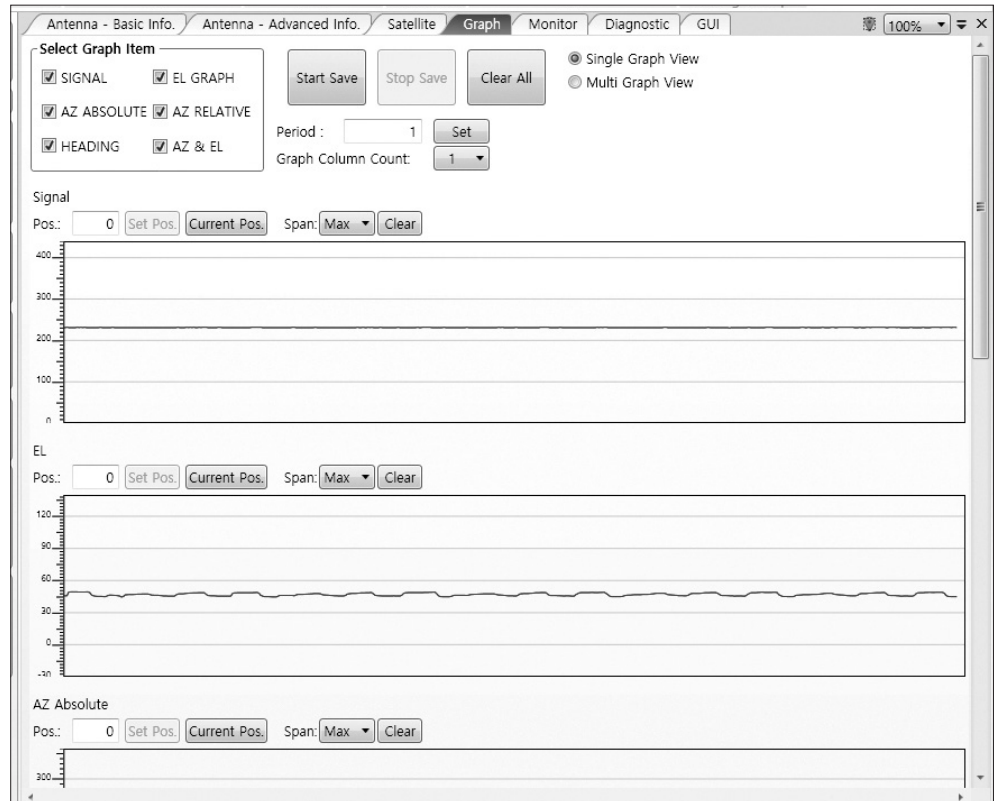

- **Select Graph Item:** shows the graphs of only the checked item(s) in a Single or Multi Graph View.
- **Single Graph View:** shows Graph Views per each single Graph Item selected in 'Select Graph Item'.
- **Multi Graph View:** shows one large integrated Graph View of multiple Graph Items selected in 'Select Graph Item'.
- **Start/Stop Save:** the chosen item is saved in the data log. The data log which stores the information displayed in the graphs can be later used for a service technician to find out a cause of any possible problem with the antenna.
- **Clear All:** clears everything drawn on the Graph View window.
- **Set Pos.:** sets the current position as center value of each Graph Item.
- **Current Pos.:** moves to the location according to values of each Graph Item.
- **Span:** sets the Display Range(s) of each corresponding Graph Item.
- **Period:** displays and sets the signal sampling rate.
- **Graph Column Count:** makes all Graph Views show in either one or two-column format.

5. Monitor

This view provides a UI which can monitor all data that has been received from the ACU.

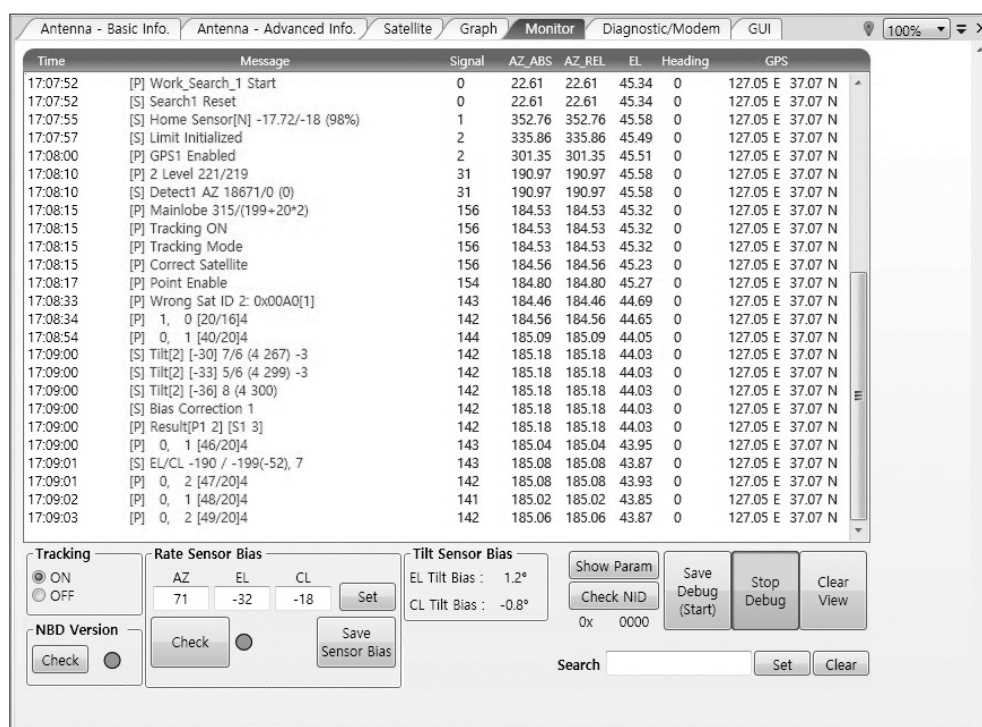

- **Tracking:** turns on or off the dish scan function. If the dish scan function is disabled, the antenna will stop adjusting the antenna pointing angle in order to optimize the receive signal level.
- **Rate Sensor Bias:** is used to calibrate the DC voltage output from the three rate sensors (azimuth, elevation, and cross-level). These are used to sense antenna motion that corresponds to the ship's motion (roll, pitch, and yaw) for stabilizing the pedestal. Push the "Check" button to check the EL and CL Tilt Bias.
- **Tilt Sensor Bias:** displays the EL and CL Tilt Bias between the antenna and the sensor.
- **Show Param:** shows the current antenna parameters.
- **Check NID:** verifies the NID (network ID) of the current tracking transponder. Press the NID button to obtain the NID only if the antenna is locked onto the desired satellite .
- **Debug (Start):** starts the debug log of the antenna. The debug message will be displayed once the debug button is pressed.
- **Stop Debug:** stops debug logging of the antenna.
- **Save Debug (Start/Stop):** starts or stops saving the debug log. This button is enabled once the Start Debug button is pressed.
- **Clear View:** clears the debug message or log data in monitoring window.

6. ACU System

This view provides Antenna Diagnostic Testing.

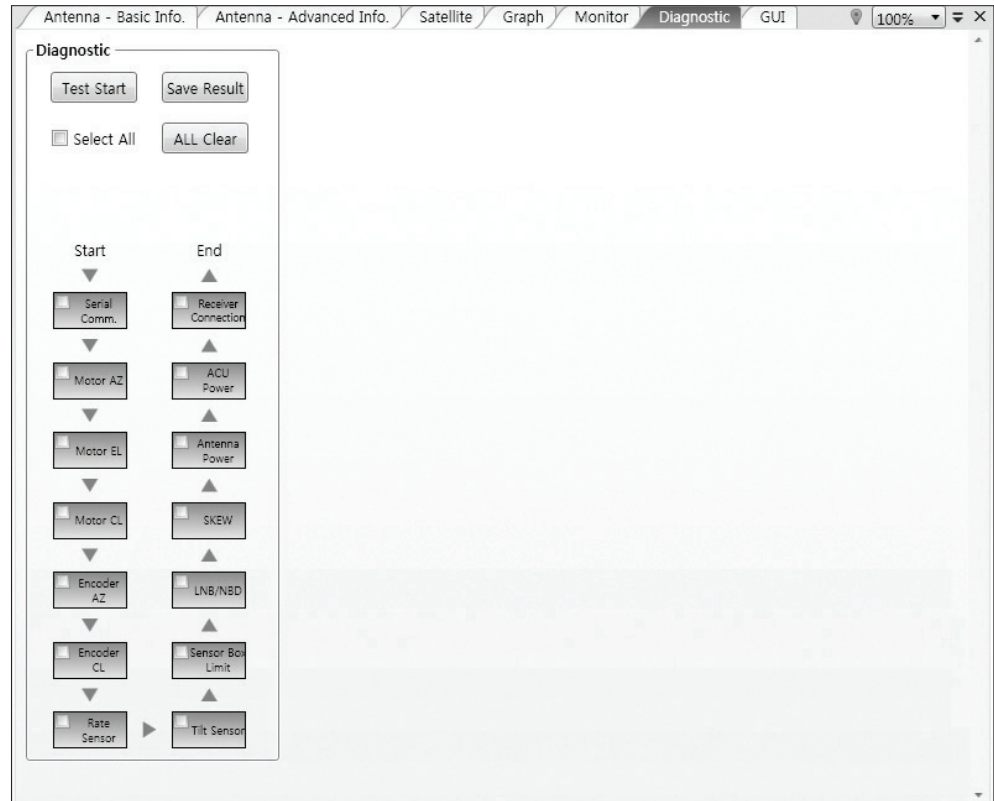

- **Diagnostic:** select to run a full diagnostic test or single diagnostic test. "Green" indicator is displayed for the test under progress. "Blue" indicates the test result as Pass while "Red" indicates the result as Fail. "Yellow" indicates the test has been skipped.
 - **Serial Comm.:** tests the data communication between the antenna and the ACU.
 - **Motor AZ:** tests the azimuth motor.
 - **Motor EL:** tests the elevation motor.
 - **Motor CL:** tests the cross-level motor.
 - **Encoder AZ:** tests the azimuth encoder.
 - **Encoder CL:** tests the cross-level encoder.
 - **Rate sensor:** tests the rate sensor.
 - **Tilt Sensor:** tests the tilt sensor.
 - **Sensor Box Limit:** tests the sensor box motor.

- **LNB/ NBD:** tests the LNB. (NBD is not available on this model.)
- **Skew:** tests the LNB skew motor.
- **Antenna power:** tests the antenna power to see whether or not it is within the nominal operating range.
- **ACU power:** tests the ACU power to see whether or not it is within the nominal operating range.
- **Receiver Connection:** tests the data communication between the antenna and the receiver.

7. Work View Functions

The seven Work View Tabs displayed in the Work View can be arranged in customized layouts.

- Layout Formatting

- Each of the Work View Tab can be separated from the rest Tabs. Click and hold the left mouse button on the Work View Tab's header and then drag a desired Tab out. When a Work View Tab is separated from the rest of your Work View Tabs, again click and hold the left mouse button on the Work View Tab's header to display a cross-shaped Navigator icon. While holding the mouse button, bring the selected Work View Tab closer to the Navigator icon and release the mouse button at your desired position (top, left, right or bottom arrow). This time, the selected Tab will be moved to the desired position.

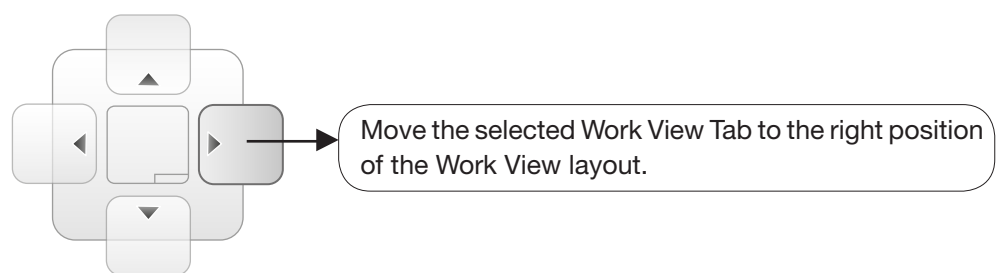
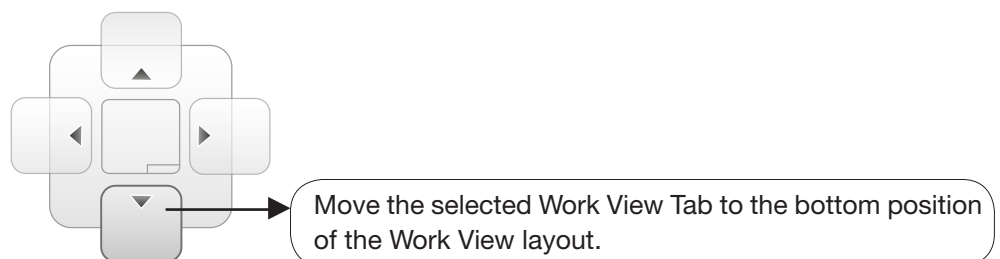
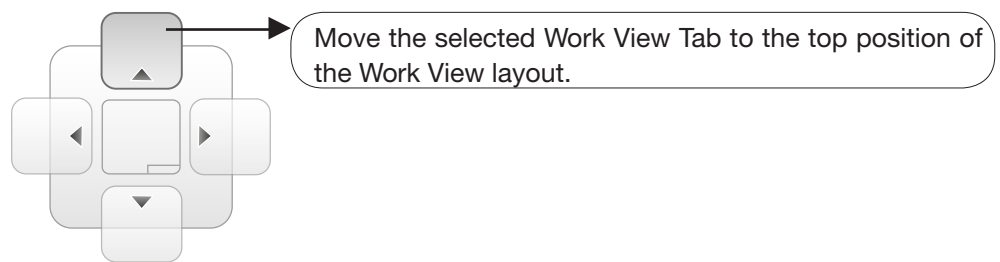

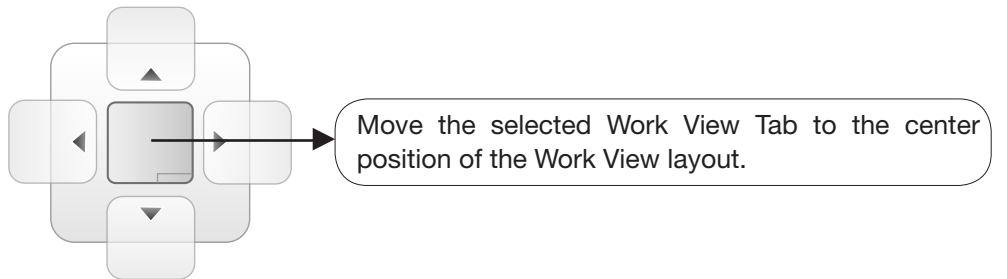
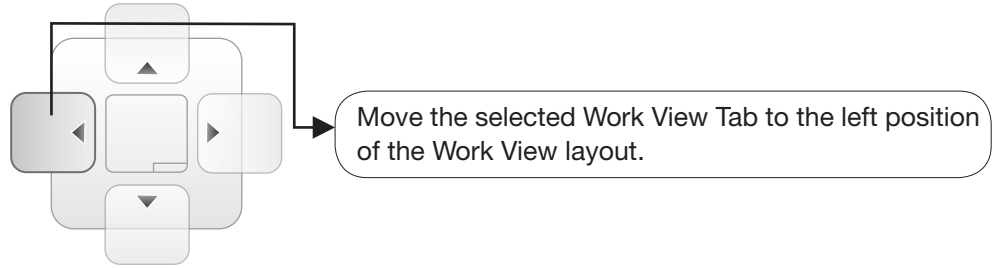

- **Horizontal or Vertical Tab Group**
 The Work View Tabs can be also aligned horizontally or vertically. Without dragging them out, right-click the mouse button on a desired Tab header and select 'New Horizontal Tab Group' or 'New Vertical Tab Group' option. Selecting 'New Horizontal Tab Group' will separate a selected Tab from the rest of other Tabs then arrange it in a horizontal format. Likewise, selecting 'New Vertical Tab Group' will separate a selected Tab from the rest of other Tabs then arrange it in a vertical format.
- **Closing the Work View Tab**
 To close the Work View Tab, right-click the mouse button on a desired Tab header and select 'Close' option in the drop down list. To close all Work View Tabs except the selected Tab, select 'Close All But This' option in the drop down list.
- **Zoom Tool**
 Using the Zoom tool, you can easily select the magnification you want by using Zoom In and Zoom Out bar, and Fit in Work View button.



Fit Work View Button: fits the current view to the Work View window size. The button toggles between the fit view and the previous view.

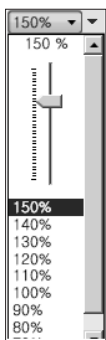

Zoom In and Zoom Out Bar: zooms in and out to expand and reduce the View to the desired size. (The zoom changes in 10% increments.)



View Switch Button: displays a list of the current views in a list. Choosing one of these views will display the selected view in the Work View window.



View Name Button: displays the current Work View name.



Close View Button: closes the current view.

APTUS WEB

Introduction

Main Page

Page Login
Top Menus
Dash Board & Information

Antenna Settings

Ship Setting
Antenna Position & Parameters
Tracking Setting
Diagnostic

Firmware & Configuration

Antenna Firmware Upgrade
Antenna Log
Antenna Backup & Restore

Administration

Network Setting
SNMP Setting
User Management
iARM Upgrade
iARM Save & Reboot
Antenna Event Log
Intellian Network Devices

Introduction

With embedded Aptus Web, the s100HD can be monitored, controlled, and diagnosed remotely from anywhere, anytime through the TCP/IP protocol. This can not only save time, but also can save the cost generated from routine maintenance activities such as operating firmware upgrades, tracking parameters resets, and system diagnostic.

How to access Aptus Web:

1. Connect an Ethernet Cable between your PC and the Management Ethernet Port.
2. Enter the ACU's IP address (192.168.2.1) into your web browser's address bar to login into the ACU's internal HTML page, if this system has not been changed from the ACU's factory default.

NOTE: Aptus Web can be displayed in Internet Explorer 8 or later and is also compatible with Firefox and Chrome web browsers.

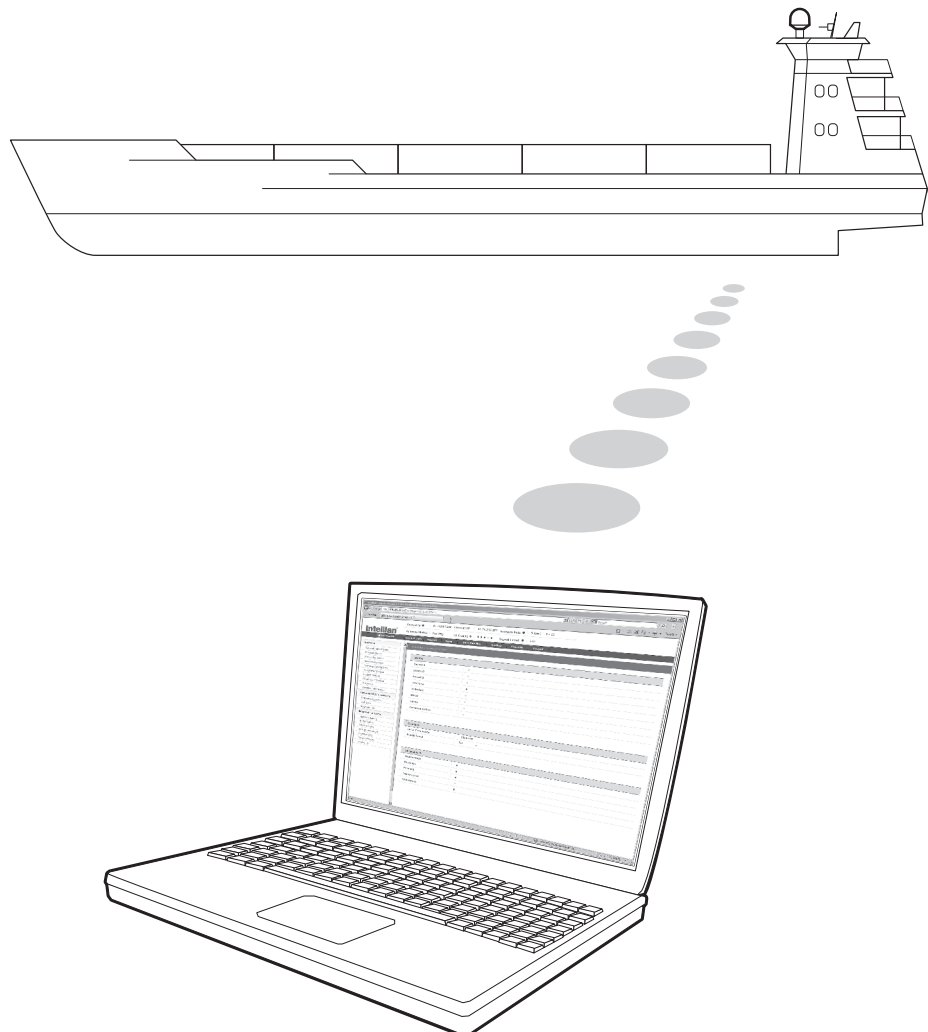

Main Page

Page Login

1. Choose either to Control & Monitor the ACU (Control & Monitoring) or Only Monitor the ACU (Monitoring Only).
2. Log into the ACU by typing in User Name and Password information. If this system has not been changed from the factory default:
 - **User Name:** intellian
 - **Password:** 12345678

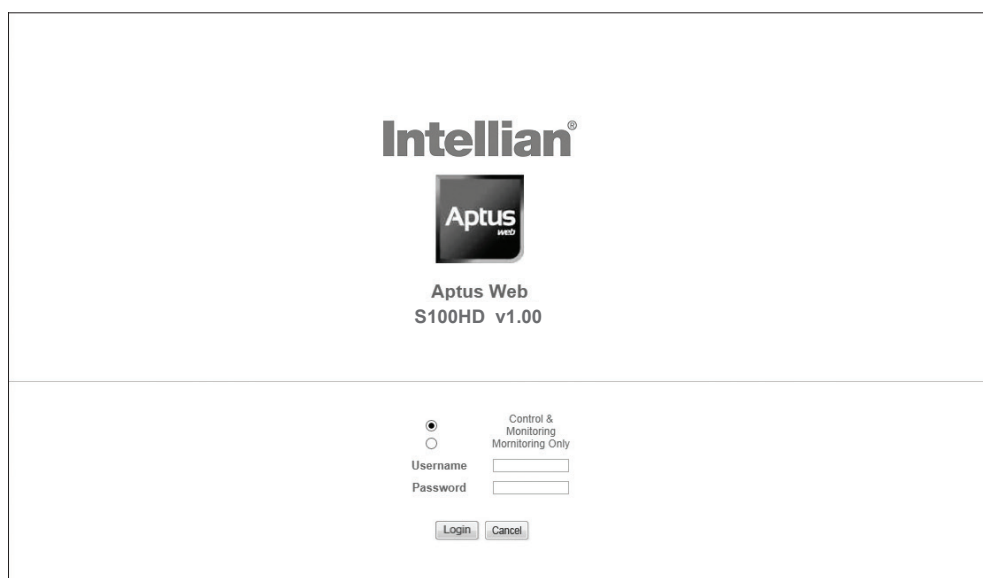

Intellian®

Aptus
Web

Aptus Web
S100HD v1.00

Control & Monitoring
 Monitoring Only

Username

Password

Login Cancel



WARNING: The Control & Monitoring Mode will be switched to the Monitoring Only Mode in the following cases;

- If PC Software (Aptus) is connected using TCP/IP Communication while Aptus Web Control is in use.
- If Aptus Web Control & Monitoring Mode is accessed while PC Software is running via TCP/IP Communication. In this case, the web page will display a pop-up message asking if you want to disconnect the PC Software network connection. If you select 'No', the Control & Monitoring Mode will be switched to the Monitoring Only Mode.

Top Menus

Once you log in, the following information and menus are displayed.



No.	Item	Description
①	Signal Level	Display current signal level.
②	Antenna status	<ul style="list-style-type: none"> - Setup: Displays whether or not the antenna is in SETUP mode. The indicator shows "Blue" in the SETUP mode. - Initial: Antenna or ACU is initialized. - Search: Antenna is searching a target satellite. - Track: Antenna is tracking the target satellite.
③	Restart	Restart the antenna system.
④	Setup	Enter SETUP mode.
⑤	Save Sat.	Save current satellite settings. Bow offset will be adjusted and saved automatically.
⑥	Ant. Info	Obtain current antenna information.
⑦	Account	Shortcut to User Management menu. Change login ID and Password.
⑧	Logout	Logout the ACU's internal HTML page.

Dash Board & Information

On the left side of the page, Dash Board and Information menus are displayed as below to provide quick monitoring of the antenna status and settings. Other menus are displayed only in the Control & Monitoring mode and their functions will be described in the next sections.

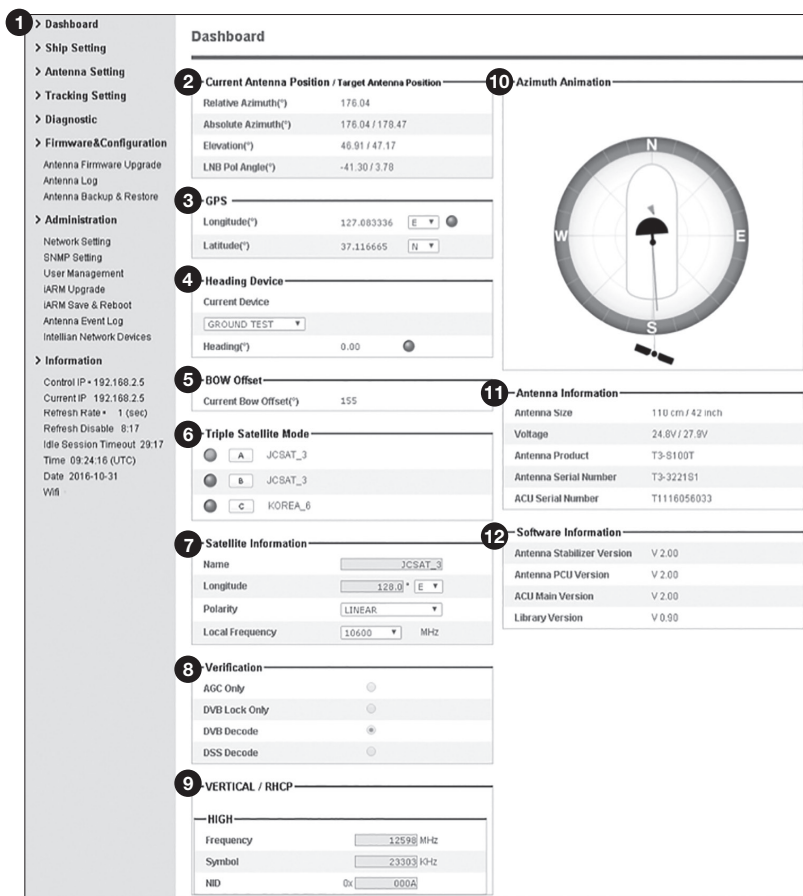

No.	Item	Description
①	Dash Board	Displays current antenna status to be quickly monitored.
②	Current Antenna Position / Target Antenna Position	Displays current antenna position. - Relative Azimuth: displays antenna relative AZ angle. - Absolute Azimuth: displays antenna absolute AZ angle. - Elevation: displays antenna elevation angle. - LNB Pol Angle: displays LNB pol angle.
③	GPS	Displays current GPS information. - Longitude (East / West) - Latitude (North / South)
④	Heading Device	Displays current Heading Device: NONE, NMEA, NMEA 2000, Ground test If the ship's gyrocompass input is other than NMEA separate purchase of NMEA Converter is required. - Heading: displays ship's heading information.

⑤	BOW Offset	Display current bow offset
⑥	Triple Satellite Mode	Mode: Select between Dual-Sat mode and Triple Sat mode.
⑦	Satellite Information	Displays the satellite name, longitude, polarity and LNB local frequency of the current satellite.
⑧	Verification	Displays current verification method for satellite tracking.
⑨	Tracking Information (Frequency band)	Displays current frequency band that consists of frequency, symbol and NID (Network ID) of a transponder in tracking the satellite.
⑩	Azimuth Animation	Shows a graphical representation of the current antenna position to identify whether or not the antenna is aligned properly to the target satellite or is in a block zone.
⑪	Antenna Information	Displays the product information
⑫	Software Information	Displays current Antenna and ACU firmware versions and Satellite Library version installed in the system. - Antenna Stabilizer Version - Antenna PCU Version - ACU Main Version - Library Version

Antenna Settings

Ship Setting

No.	Item	Description
①	Ship Setting	Set the ship information and find antenna angle.
②	GPS	Set GPS information. - Longitude (East/West) - Latitude (North/South)
③	Bow Offset	Set Bow Offset if needed.
④	Heading Device	Set ship's heading device (NONE, NMEA, NMEA2000, Ground Test) and ship's heading information.
⑤	Antenna Angle	Find the current antenna angles and skew angle in relation to the longitude (orbit position) of the antenna's current GPS. Click 'Find Angles & Skew Antenna GPS' button.



WARNING: Enter the SETUP mode for configuration. Tick the checkbox before modifying the settings. After configuration, click 'Set ...' button to submit the settings.

Antenna Position & Parameters

The screenshot shows the 'Antenna Setting' page in a web interface. On the left is a navigation menu with categories like Dashboard, Ship Setting, Antenna Setting (highlighted with a '1'), Tracking Setting, Diagnostic, Firmware & Configuration, Administration, and Information. The main content area is titled 'Antenna Setting' and contains several sections, each with a numbered callout:

- 1**: The overall 'Antenna Setting' page.
- 2**: 'Current Antenna Position / Target Antenna Position' section showing fields for Relative Azimuth (196.18), Absolute Azimuth (196.18 / 198.05), Elevation (44.57 / 45.61), LNB Pol Angle (14.00 / 14.25), and Heading (0.00).
- 3**: 'Manual Movement' section with sliders for Azimuth Angle (5.00), Elevation Angle (5.00), and LNB Pol Angle (5.00).
- 4**: 'LNB Pol Sensor Calibration' section with input fields for SAT A (14.2, 0.0) and SAT B (2.2, 11.9), and a 'Pol Sensor Calibration' button.
- 5**: 'Scan Offset' section with a 'Scan Offset' input field (75) and a 'Set Scan Offset' button.
- 6**: 'Elevation Adjust' section with an 'EL Adjust' input field (-1.8) and a 'Set EL Adjust' button.
- 7**: 'Conical Range' section with 'Azimuth' and 'Elevation' input fields (both 120) and a 'Set Range' button.
- 8**: 'Idle Mode' section with an 'Idle Mode' button.
- 9**: 'Reboot' section with a 'Reboot' button.
- 10**: 'Flag Setting' section with checkboxes for 'Use WRS Method' (checked) and 'Use Offset Difference' (unchecked), and a 'Set Flags' button.
- 11**: 'Search & Tracking Parameter Setting' section with various thresholds and ranges for Search 1, 2, and 3, including 'Detect Level Threshold', 'Tracking Level Threshold', 'Wait Time(s)', 'Search Step', and 'Search 1 Range' through 'Search 3 Range'.
- 12**: 'Tilt Sensor Bias' section with a 'Tilt Sensor' status (Ready), radio buttons for 'Elevation' and 'Cross Level', and a 'Step' input field (1.00).
- 13**: 'Rate Sensor Adjust' section with 'Azimuth' (-99), 'Elevation' (-11.4), and 'Cross-level' (76) input fields, and buttons for 'Set Rate Sensor Bias' and 'Rate Sensor Calibration'.
- 14**: 'Parameter Setting' section with various thresholds and counts like 'Initial Sat Count' (50), 'WRS Detect Level' (300), 'Voltage Threshold' (650), 'DiSeqC Threshold' (100), 'Sat Verify Time' (1500), 'Tracking Stable Count' (20), 'Offset Diff AZ-EL' (30), 'Search Lock Count' (4), and 'Offset Diff RH-LH' (0).

No.	Item	Description
①	Antenna Setting	Set current antenna position and Search and Tracking parameters. These parameters should only be changed by an authorized service technician. Improper setting of these parameters will render your system inoperable.
②	Current Antenna Position/ Target Antenna Position	Display current antenna position. - Relative Azimuth: display antenna relative AZ angle. - Absolute Azimuth: display antenna absolute AZ angle. - Elevation: display antenna elevation angle. - LNB Pol Angle: display LNB pol angle. - Heading: display ship's heading information.
③	Manual Movement	Move antenna azimuth and elevation angles and LNB pol angle to find the desired satellite manually. LNB Pol Angel can be adjusted at any time either in SETUP Mode or Tracking Mode.

No.	Item	Description
④	LNB Pol Sensor Calibration	Calibrate the LNB pol angle when the control board, potentiometer or belt is replaced.
⑤	Scan Offset	The scan offset is to offset the angle difference between the black marker on the sub-reflector and the optical sensor.
⑥	Elevation Adjust	Adjust the elevation to offset the angle difference between the mechanical elevation angle and actual elevation angle.
⑦	Conical Range	The relative force of the motors controlling azimuth and elevation. Set the conical range while the antenna is in tracking mode.
⑧	Idle Mode	Release the elevation and cross level motor brakes while the antenna is in SETUP mode. The antenna can be moved manually during the mode.
⑨	Reboot	Reboot the system.
⑩	Flag Setting	Set the flag settings. Select 'Use WRS Method' to use 'WRS (Wide Range Search) Detect Level'. Select 'Use Offset Difference' to enable the system to offset the signal difference between RHCP and LHCP.
⑪	Search & Tracking Parameter Setting	<ul style="list-style-type: none"> - Detect Level Threshold: display / set current detect level threshold to set the satellite signal detection level. - Tracking Level Threshold: display /set current tracking level threshold to set the satellite signal tracking level. - Wait Time: set the time-out for automatic initiation of a search after the signal level drops below the pre-defined threshold value. - Search Step: set increment step size. - Search 2 Range: is reserved for future use. - Search 1 Range: set Search 1 search range. The antenna is detecting the satellite signal which is above the current detect level threshold. The search range corresponds to Search Type 1. Once the signal is located, the antenna will enter to "Search 3 mode". - Search 3 Range: set Search 3 search range. The antenna is detecting the satellite signal which is above current tracking level threshold. The search range corresponds to Search Type 3. Once the signal is located, the antenna will enter "Tracking mode".
⑫	Tilt Sensor Bias	Adjust the two solid-state tilt sensors used to provide absolute cross-level tilt of the antenna and elevation feedback to eliminate long-term pointing drift (error). Tilt bias is required to be adjusted when the antenna control board or sensor box is replaced. Check to see whether or not the bubble is located at the center of the level vial.

No.	Item	Description
⑬	Rate Sensor Adjust	Calibrate DC voltage output from the three rate sensors used to sense antenna motion in azimuth, elevation and cross-level axes. During the calibration process, the antenna should avoid any motion as it can affect the antenna's performance.
⑭	Parameter Setting	<ul style="list-style-type: none"> - Initial Sat Count: Set the threshold count for maintaining tracking. - WRS Detect Level: Set the WRS detection level. - Voltage Threshold: Set the voltage threshold. The voltage threshold is to distinguish the voltage between 13 V and 18V. - DiSEqC Threshold: Set the DiSEqC threshold. The DiSEqC threshold is to distinguish the 0KHz tone and 22 KHz tone. - Sat Verify Time: Set the threshold count for the satellite verification. - Tracking Stable Count: Set the threshold count for stabilizing the satellite before tracking. - Offset Diff AZ-EL: Set the offset difference between Azimuth and Elevation range. - Search Lock Count: Set the threshold count for locking on the satellite before tracking. - Offset Diff RH-LH: Set the offset difference between RHCP and LHCP signals.



WARNING: Tick the checkbox before modifying the settings. After configuration, click 'set...' button to submit the settings.

Tracking Setting

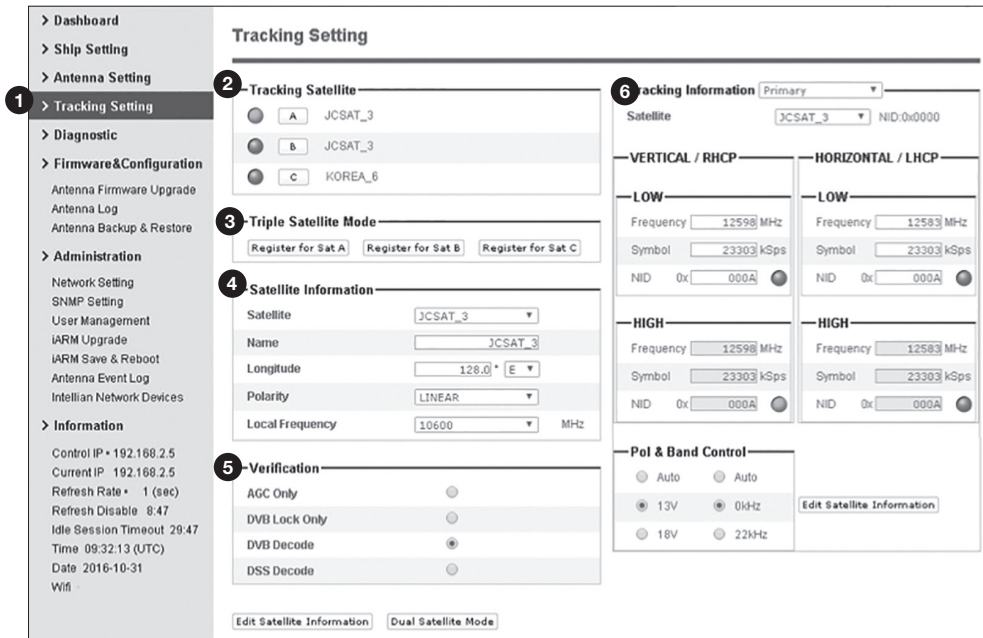

No.	Item	Description
①	Tracking Setting	Display or set current tracking satellite and tracking information.
②	Tracking Setting	Select the tracking satellite.
③	Triple Satellite Mode	Register the selected satellite in Tracking Satellite for Sat A, Sat B or Sat C. To select between Dual-Sat mode and Triple-Sat mode, press the 'Dual Satellite Mode' button or 'Triple Satellite Mode' button on the bottom of the screen.
④	Satellite Information	Set the satellite name, longitude, polarization and local frequency of LNB to be used.
⑤	Verification	Set the verification type for satellite tracking (AGC Only, DVB Lock Only, DVB Decode, DSS Decode)
⑥	Tracking Information	Tracking information consists of frequency, symbol and NID (Network ID) of a transponder in tracking satellite. There are four groups of tracking information. "Vertical/RHCP" is applied when IRD supply 13V, and "Horizontal/LHCP" is applied when IRD supply 18V. "LOW" is applied when DiSEqC signal (0 kHz tone) is not detected from IRD. "HIGH" is applied when DiSEqC signal (22 kHz tone) is detected from IRD. Pol & Band Control: The "Pol" controls 13V (Vertical/ RHCP band) or 18V (Horizontal/ LHCP band). The "Band" controls DiSEqC 0KHz tone (Low band) and 22KHz tone (High band) After modifying information, press 'Edit Satellite Information' button, then new information is updated in the antenna.

Diagnostic

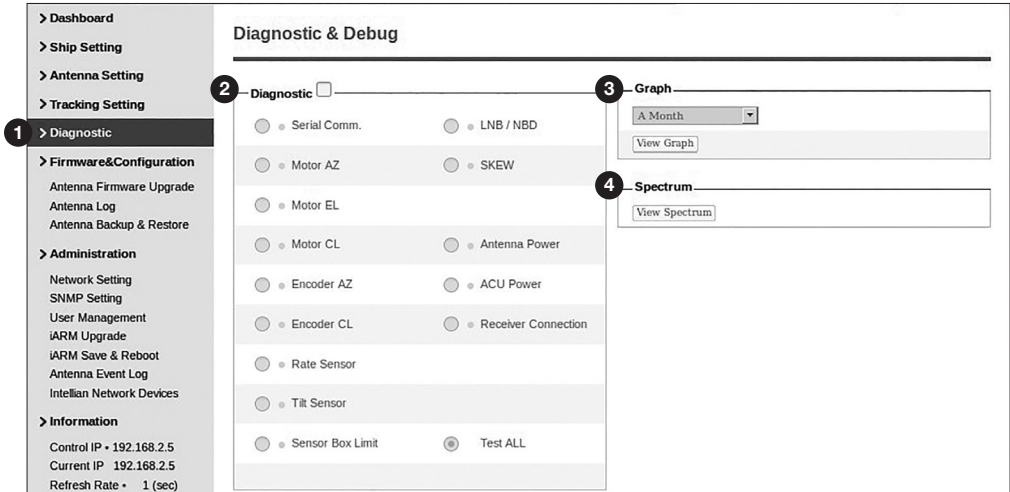

No.	Item	Description
①	Diagnostic	Execute antenna diagnostic test.
		Select to run a full diagnostic test or single diagnostic test.
		- Serial Comm.: test the data communication between the antenna and the ACU.
		- Motor AZ: test the azimuth motor.
		- Motor EL: test the elevation motor.
		- Motor CL: test the cross-level motor.
		- Encoder AZ: test the azimuth encoder.
		- Encoder CL: test the cross-level encoder.
②	Diagnostic	- Rate Sensor: test the rate sensor.
		- Tilt Sensor: test the tilt sensor.
		- Sensor Box Limit: test the sensor box motor.
		- LNB/NBD: test the LNB.
		- SKEW: test the LNB pol motor.
		- Antenna Power: test the antenna power.
		- ACU Power: test the ACU power.
		- Receiver Connection: test the data communication between the antenna and the receiver.

No.	Item	Description
③	Graph	Select to view a graph of AZ Absolute, AZ Relative, EL and Heading data of the antenna. <ul style="list-style-type: none">- A Month: display all data within a month- A Week: display all data within a week- A Day: display all data in a day- Real-time: display data in real time. Press F5 button to refresh.- Data Num: set the maximum number of graph data set to be displayed.- View Graph: select to view the data graph.
④	Spectrum	Select to view a current spectrum graph and to set the spectrum.



WARNING: Click the checkbox before modifying the settings. Click Diagnosis button to execute diagnostic test. To clear previous diagnosis result, click Diagnosis Clear button.

Firmware & Configuration

Antenna Firmware Upgrade

No.	Item	Description
①	Antenna Firmware Upgrade	Upgrade antenna and ACU firmware version.
②	New Antenna Firmware	Select Upgrade Method between Manual Upgrade or Auto Upgrade. With Manual Upgrade option selected, browse and select the firmware package file to upload and click Start Upload button. With Auto Upgrade option selected, click Check button to check automatically if there is new firmware available from the server.
③	Current Running Version	Displays current firmware versions (Antenna STABILIZER, Antenna PCU, ACU main, Library)
④	Cold Rollback	Display Previous/Latest Package version and rollback firmware to Previous or Latest version (Can do nothing while rollback is in progress)

Upgrade procedures:

1. Select the upgrade package file. In Auto Upgrade mode, check new firmware file automatically by clicking Check button.
2. Click on "Start Upload" button to transfer the Firmware package file (*.fwp") to iARM module. In Auto Upgrade mode, click "Upgrade" button once new firmware file is detected.
3. After the package file is transferred, it'll show "upgrade from vx.xx Version to vx.xx Version". Enable the check box to select the firmware file to upgrade. To select all firmware files, click Select All boxes.
4. Click on "Start Upgrade" button.

Antenna Firmware Update		
The Firmware Package Update Ready		
Antenna STABILIZER	Update From v2.00 To v4.07 From 0x0001 To 0x0013	<input checked="" type="checkbox"/>
Antenna PCU	Update From v2.00 To v4.07 From 0x0002 To 0x0014	<input checked="" type="checkbox"/>
ACU MAIN	Update From v2.00 To v4.03 From 0x0003 To 0x0015	<input checked="" type="checkbox"/>

[Start Update](#)

Firmware upgrade status page

Antenna Firmware Update		
The Firmware Package v131203 Update Status		
Antenna STABILIZER	Update From v4.00 To v4.00 20 %	
Antenna PCU	Update From v4.00 To v4.00 Ready	
ACU MAIN	Update From v4.00 To v4.00 Ready	

[Back to main page](#)

5. During upgrade process, the window will display process status.

Upgrade process status page

Antenna Firmware Update

The Firmware Package v131203 Update Status

Antenna STABILIZER	Update From v4.00 To v4.00 Success
Antenna PCU	Update From v4.00 To v4.00 Success
ACU MAIN	Update From v4.00 To v4.00 70 %

[Back to main page](#)

6. If the firmware is successfully upgraded, it'll display "The firmware update is completed."

Upgrade complete page

The Firmware Package v131203 Upgrade Complete

Antenna STABILIZER "4.00" "Success"
 Antenna PCU "4.00" "Success"
 ACU MAIN "4.00" "Success"

The firmware update is completed.
 If you receive an fail message, please try again.
 Please refer to the User Guide if you have trouble connecting to the antenna.

[Back to main page](#)

7. Click on "Back to main page" to go out of the screen.
 To verify the upgraded firmware version, go to Dash Board > Software Information.

NOTE: To roll back to the previous firmware package version or latest package version, select Rollback Upgrade menu on the Antenna Firmware Upgrade page.

Antenna Log

Antenna Log

1 Antenna Log

2 GPS Log Option

Enable [Help](#)

3 Antenna Log Download

Download Method:

You can download the log of up to 3 Months.
Start Date: End Date:

4 Include Backup/Report File

5 Antenna Firmware Log

Date/Time(UTC 00:00)	STAB	PCU	Main
Fri, 19 Dec 2014 01:40:49	4.07 Skip	4.07 Skip	4.03 Success
Fri, 19 Dec 2014 01:39:31	4.07 Skip	4.07 Skip	4.03 Success

Control IP • 192.168.2.5

No.	Item	Description
①	Antenna Log	Displays antenna log data
②	GPS Log Option	Disable/Enable to save GPS information in the antenna log file.
③	Antenna Log Download	Select file transfer protocol between HTTP Download or FTP Download. For the GX terminals, the default option is HTTP Download. Any log data within 3 months can be downloaded with HTTP Download option selected. Select the start and end date by manual input or mouse-scrolling on the calendar view.
④	Start Download	Select the Start Download button to download the antenna log file. Download the Back up/Report file by clicking the 'Include Backup/Restore File' check box.
⑤	Antenna Firmware Log	Displays log information of firmware upgrade(s).

Log Download procedures:

1. Select 'Start Download' button.
2. To run Java applications you must have Java Runtime Environment (JRE) version 6.0 and above installed in your PC/ laptop when you access the antenna log page for first time. Click "Run" button on the popup message "The application's digital signature cannot be verified. Do you want to run the application? " to install the Applet. Refer to Appendix for Java Installation Instructions, if the system does not display the popup message.

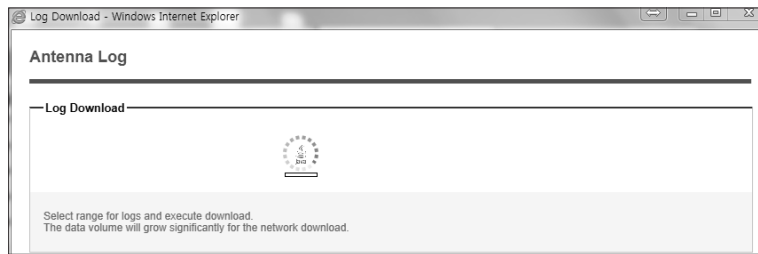

3. Select 'Browse' to browse the target directory of the antenna log file.
4. Select log period for file download.
 - Last 3 Months: download the antenna log information for the past three months.
 - Last 1 Month: download the antenna log information for the past one month.
 - Last 1 week: download the antenna log information for the past one week.
 - Last 1 Day: download the antenna log information for the past one day.
5. Select 'Download' to download the log file to the target directory according to the selected log period.

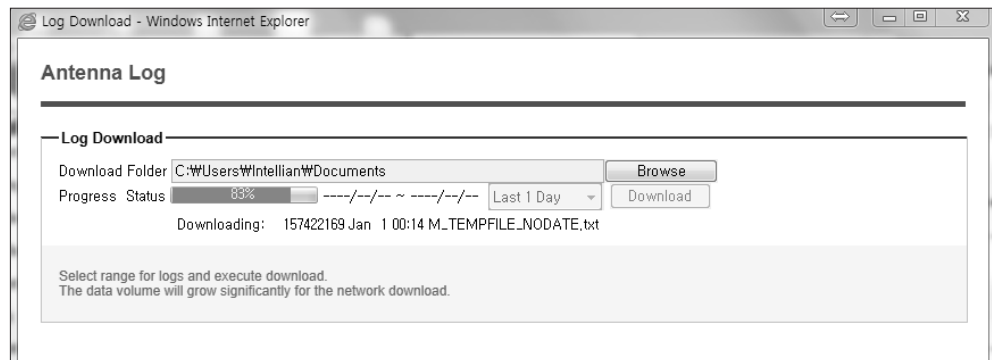

NOTE: In s100HD system, users can choose to Enable or Disable the GPS tracking function. Liability for information that is disclosed when GPS is enabled is solely the operator responsibility and it is up to the operator on whether or not to provide their GPS information to third parties. Any issues regarding safety and privacy when turning on the GPS function is solely up to the user. Intellian is not responsible for information that is disclosed when the GPS function is enabled.

Antenna Backup & Restore



No.	Item	Description
①	Antenna Backup & Restore	Enter Backup & Restore page. (Setup mode is required)
②	Target	Backup antenna information to ACU/PC or restore antenna by using the saved information from ACU/PC.
③	Backup	Backup antenna information.
④	Restore	Restore antenna information.

Administration

WARNING: Ensure to enter the SETUP mode before starting configuration. After completing the modification of settings, enter Save & Reboot page and click on "Save & Reboot" button. Without doing so, the modified settings will be lost.

Network Setting

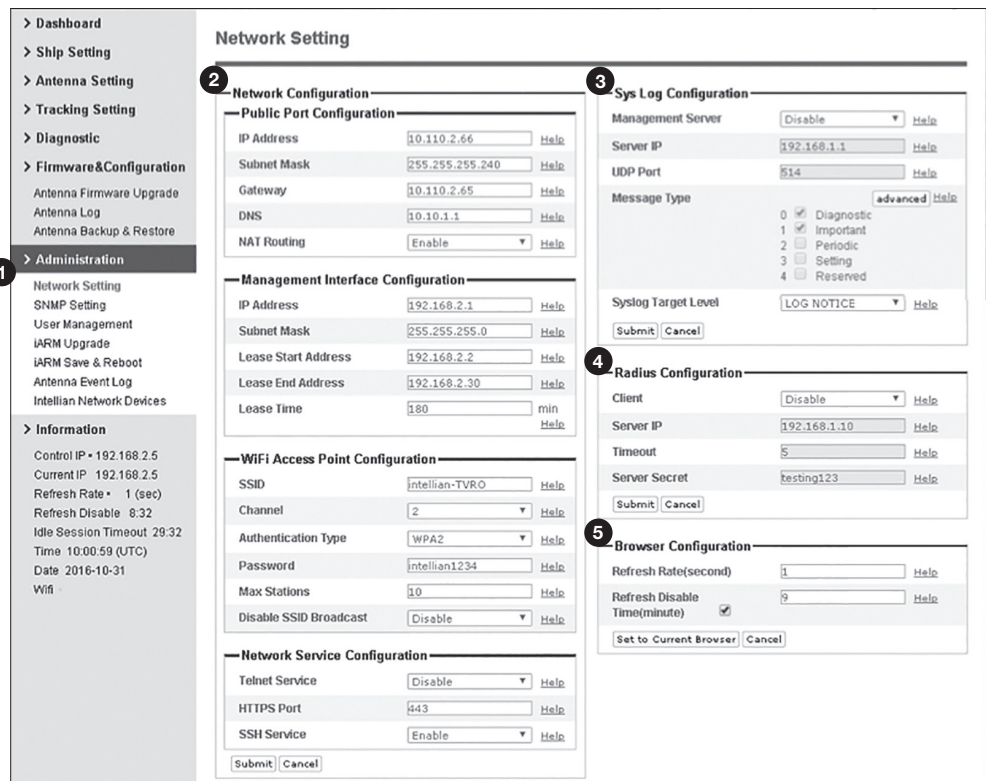

No.	Item	Description
①	Network Setting	Enter network setting page.
②	Network Configuration	<p>Modify ACU's internal IP addresses, routing, and ports. When complete press "Submit" button at bottom of page. Go to the "Save & Reboot" page and click the Save & Reboot button to validate the changes.</p> <ul style="list-style-type: none"> • Public Port Configuration <ul style="list-style-type: none"> - IP Address: Factory default (Primary: 192.168.0.223)/ (Secondary: 10.10.1.1). - Subnet Mask: Factory default (255.255.255.0). - Gateway: Factory default (192.168.0.254). - DNS: Current default DNS Address is assigned to. - NAT Routing: Enable/Disable NAT routing. • Management Interface Configuration. <ul style="list-style-type: none"> - IP Address: ACU front network port / Factory default (Primary: 192.168.2.1) / (Secondary: 10.10.10.1). - Subnet Mask: Factory default (255.255.255.0). - Lease Start Address: Lease IP address start range. - Lease End Address: Lease IP address end range. - Lease Time: Lease IP address update time.

	<ul style="list-style-type: none"> • Wi-Fi Access Point Configuration. - SSID: The SSID is the network name shared among all devices in a wireless network. The SSID must be identical for all devices in the wireless network. It is case-sensitive and must not exceed 32 alphanumeric characters, which may be any keyboard character. Make sure this setting is the same for all devices in your wireless network. - Channel: Select an appropriate channel from the list provided to correspond with your network settings. All devices in your wireless network must use the same channel in order to function correctly. Try to avoid conflicts with other wireless networks by choosing a channel where the upper and lower three channels are not in use. - Authentication Type: Module supports an authentication mode that the 802.11 device uses when it authenticates and associates with an access point or IBSS cell. - Password: Wi-Fi access password. - Max Stations: Setting max stations. - Disable SSID Broadcast: Choose to Enable or Disable the WiFi SSID function. • Network Service Configuration. - Telnet Service: Enable or disable telnet login support. - HTTPS Port: HTTPS port number. - SSH Service: Choose to Enable or Disable the CLI access through the SSH protocol.
<p>③ Sys Log Configuration</p>	<p>Set the Syslog Configuration. Antenna makes log messages according to emergency level. When this function is enabled, your management server receives the log messages.</p> <ul style="list-style-type: none"> • Management Server: Syslog function enable/disable. • Server IP: Management server IP address. • UDP Port: Management port. • Message Type: Select message type (Intellian message level) to send management server (The lower level is more emergency). • Syslog Target Level: If you select this target level, the Server receives log message equal or less than this level.
<p>④ Radius Configuration</p>	<p>This menu is used when network administrator needs to authorize user connections via Web, SSH, PC Port, Telnet, or Console using RADIUS server.</p> <ul style="list-style-type: none"> - Client: Select to enable RADIUS authentication. - Server IP: RADIUS server IP Address - Timeout: Timeout value in seconds for the authentication process. - Server Secret: Pass-Phase. This should be matched between server and ACU.
<p>⑤ Browser Configuration</p>	<p>Set the refresh rate and the refresh disable time.</p> <ul style="list-style-type: none"> • Refresh Rate: Set the browser refresh rate (Default 1 seconds. Range 1~99). • Refresh Disable Time: Set the browser idle timeout (Default:9 minutes. Range 0~9). <p>If you tick the checkbox, you can use this function.</p>

SNMP Setting

No.	Item	Description
①	SNMP Setting	Display and Set SNMP configuration.
②	SNMP V1/V2 Status	Set SNMP mode (Use Attribution Disable, Read Only or Read Write).
③	V1/V2 Community Name	Set SNMP V2 community name.
④	V3 Authentication Type	Set SNMP V3 authentication mode.
⑤	V3 Authentication Encoding	Set SNMP V3 authentication encoding.
⑥	V3 Username	Set the V3 username and password of the SNMP Agent. The password must be at least 8 character string.
⑦	V3 Private Encoding	Set SNMP V3 Private Encoding.
⑧	V3 Private Password	Set the V3 password of the SNMP Agent. The Password is must be at least 8 character string.
⑨	TRAP IP/Port	Set the V3 password of the SNMP Agent. The Password is must be at least 8 character string.
⑩	TRAP Parameter	Set the SNMP trap specific parameter.

User Management

- > Dashboard
- > Ship Setting
- > Antenna Setting
- > Tracking Setting
- > Diagnostic
- > Firmware&Configuration
 - Antenna Firmware Upgrade
 - Antenna Log
 - Antenna Backup & Restore
- > Administration
 - Network Setting
 - SNMP Setting
 - 1 User Management
 - iARM Upgrade
 - iARM Save & Reboot
 - Antenna Event Log
 - Intellian Network Devices
- > Information
 - Control IP • 192.168.2.5
 - Current IP 192.168.2.5
 - Refresh Rate • 1 (sec)
 - Refresh Disable 8:45
 - Idle Session Timeout 29:45
 - Time 10:07:55 (UTC)
 - Date 2016-10-31
 - Wifi

User Management

2 Change ID & Password

Change ID

Current ID

New ID

Change Password

Enter Current Password

Enter New Password

Confirm New Password

3 Change User Settings

Password Expire Timeout

Timeout in days day

Idle Session Timeout

for Console login min

for Network login min

Guest Session Access

Allow Connections ▼

No.	Item	Description
①	User Management	Change login ID and Password to access the Web M&C. This setting can be also accessed by 'Account' icon on the top menu.
②	Change ID & Password	Change your login ID (user name) and password. <ul style="list-style-type: none"> - Change ID: Enter your current login ID (user name) and new login ID. Click the Submit button to validate the changes that are made to the login ID. - Change Password: Enter your current login password and new login password. Click the Submit button to validate the changes that are made to the login password.
③	Change User Settings	Change User Password Expire in days and Idle session timeout. <ul style="list-style-type: none"> - Password Expire Timeout: Set password expire in days. - Idle Session Timeout: Set for Console and for Network Timeout. - Guest Session Access: Set up the guest access option.

iARM Upgrade

1 iARM Upgrade

2 New iARM Firmware

Upgrade Method: Ignore warnings during installation and force the installation to continue

Browse and select the firmware file to upload.

3 Bootstrap/Bootloader

Bootstrap	Main	v1.05
	Factory Default	v1.05
Bootloader	Main	v1.00
	Factory Default	v1.00
	Active Bootloader	Main

4 Kernel/File System

Sys0	Kernel	v1.60	<input type="button" value="Activate"/>
	File System	v1.00	
Sys1	Kernel	v1.60	<input type="button" value="Activate"/>
	File System	v1.16	
Factory Default	Kernel	v1.60	<input type="button" value="Activate"/>
	File System	v1.14	
Current Active	Sys0		
	Active Kernel	v1.60	
	Active File System	v1.00	

No.	Item	Description
①	iARM Upgrade	Upgrade the firmware of iARM module.
②	New iARM Firmware	Select Upgrade Method between Manual Upgrade or Auto Upgrade. With Manual Upgrade option selected, browse and select the firmware file to upload and click Start Upgrade button. With Auto Upgrade option selected, click Check button to check automatically if there is new firmware available from the server.
③	Bootstrap /Bootloader	Displays current bootstrap and bootloader version.
④	Kernel /File System	ACU has 4 storage parts sys0, sys1, Factory Default, and Current Active. Display kernel and file system version and current activated part Information.

iARM firmware upgrade procedures:

1. Click on "Browse" button to select the iARM firmware file (.tgz) that you wish to upgrade. In Auto Upgrade mode, check new firmware file automatically by clicking Check button.
2. Click on "Start Update" button to update the iARM firmware. Wait until the page is loaded. In Auto Upgrade mode, click "Upgrade" button once new firmware file is detected.

Firmware upload in progress

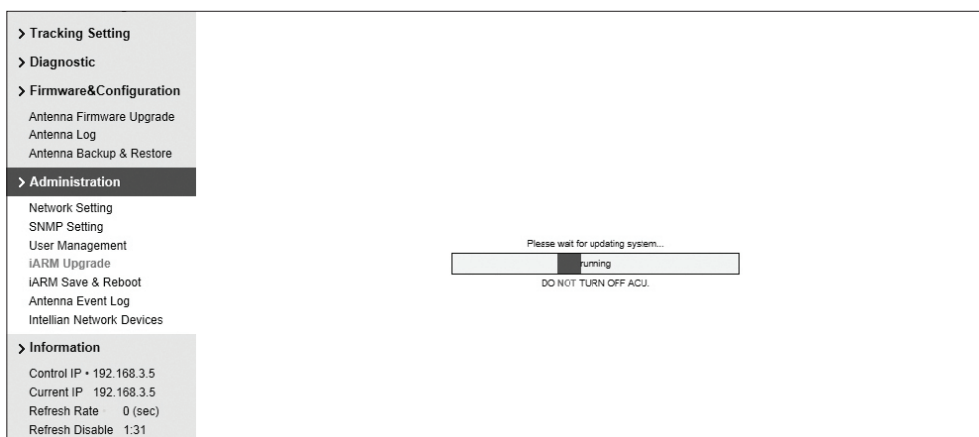

3. Do not turn off the ACU power if the firmware upgrade page is displayed. It should take around 2 minutes to complete the firmware upgrade. Once the upgrade is completed, the system will reboot automatically.

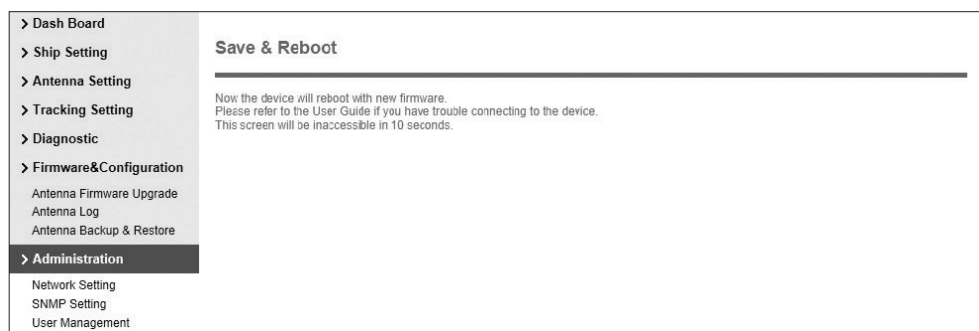

4. The connection will be disconnected during the reboot. It'll take around 30 seconds to reboot the iARM module and get the connection back again. (Disconnection message may vary depending on the web browsers.)

iARM Save & Reboot

The screenshot shows the 'iARM Save & Reboot' web interface. On the left is a navigation menu with the following items: > Dash Board, > Ship Setting, > Antenna Setting, > Tracking Setting, > Diagnostic, > Firmware&Configuration (with sub-items: Antenna Firmware Upgrade, Antenna Log, Antenna Backup & Restore), > Administration (highlighted with a circled '1'), and > Information (with sub-items: Control IP • 175.195.19.5, Current IP 175.195.19.5). The main content area is titled 'iARM Save & Reboot' and contains two sections. The first section, 'Save & Reboot' (highlighted with a circled '2'), contains the text 'All configuration changes made will be saved in the ACU and effective upon reboot.' and a 'Save & Reboot' button. The second section, 'Reboot without Saving' (highlighted with a circled '3'), contains the text 'All configuration changes made will be lost upon reboot.' and a 'Reboot Only' button.

No.	Item	Description
①	iARM Save & Reboot	Save settings to the ACU and reboot or reboot the system without saving.
②	Save & Reboot	Save the modified settings and reboot the system. Click Save & Reboot button.
③	Reboot without Saving	Reboot the system without saving the modified settings. Click Reboot Only button.

Antenna Event Log

Antenna Event Log

2 Query Filter

Severity: All
 Time Frame: Last 1 Day
 Category: All
 Sorting Order: Descending Ascending

Query Event Log

3 Event Log

Date/Time(UTC)	Severity	Category	Log
2016-10-31 09:23:32	Normal	Access	Remote Control Login through WEB from 192.168.2.5 using ID intellian
2016-10-31 09:21:47	Normal	Access	Remote Control Login through WEB from 192.168.2.5 using ID intellian
2016-10-31 09:05:30	Normal	Access	Remote Control Login through WEB from 192.168.2.5 using ID intellian
2016-10-31 09:03:58	Normal	Access	Remote Control Login through WEB from 192.168.2.5 using ID intellian
2016-10-31 09:00:19	Normal	System	BIM successfully booted up in SYS0
2016-10-31 09:00:17	Major	System	Skipped Recoveing Atp/mmcblk0p2\event_log.db : Atp/mmcblk0p2 is not mounted
2016-10-31 07:37:51	Normal	Access	Remote Control Login through WEB from 192.168.2.5 using ID intellian
2016-10-31 07:37:51	Normal	System	BIM successfully booted up in SYS0
2016-10-31 07:37:49	Major	System	Skipped Recoveing Atp/mmcblk0p2\event_log.db : Atp/mmcblk0p2 is not mounted
2016-10-31 07:33:28	Normal	Access	Remote Control Login through PC Client from ipv4_top:192.168.2.5:59782 using ID intellian
2016-10-31 07:10:24	Normal	Access	Remote Control Login through WEB from 192.168.2.5 using ID intellian
2016-10-31 06:55:06	Normal	Access	Remote Control Login through WEB from 192.168.2.5 using ID intellian
2016-10-31 06:54:50	Normal	Access	Remote Monitor Login through WEB from 192.168.2.5 using ID intellian
2016-10-31 06:53:14	Normal	Access	Remote Control Login through PC Client from ipv4_top:192.168.2.5:59500 using ID intellian
2016-10-31 06:44:27	Normal	Access	Remote Control Login through PC Client from ipv4_top:192.168.2.5:59442 using ID intellian

No.	Item	Description
①	Antenna Event Log	Displays user's log information (Data/Time, Login ID and IP)
②	Query Filter	Set the Log message option. - Severity: Set urgency level. - Category: Set target that caused the message. - Time Frame: Set time limit that you want to show. - Sorting Order: Sorting based on date (descending or ascending).
③	Event Log	Displays log information (Date/Time, Severity, Category, Log). - Save Event Log: Save log message to your PC.

Intellian Network Devices

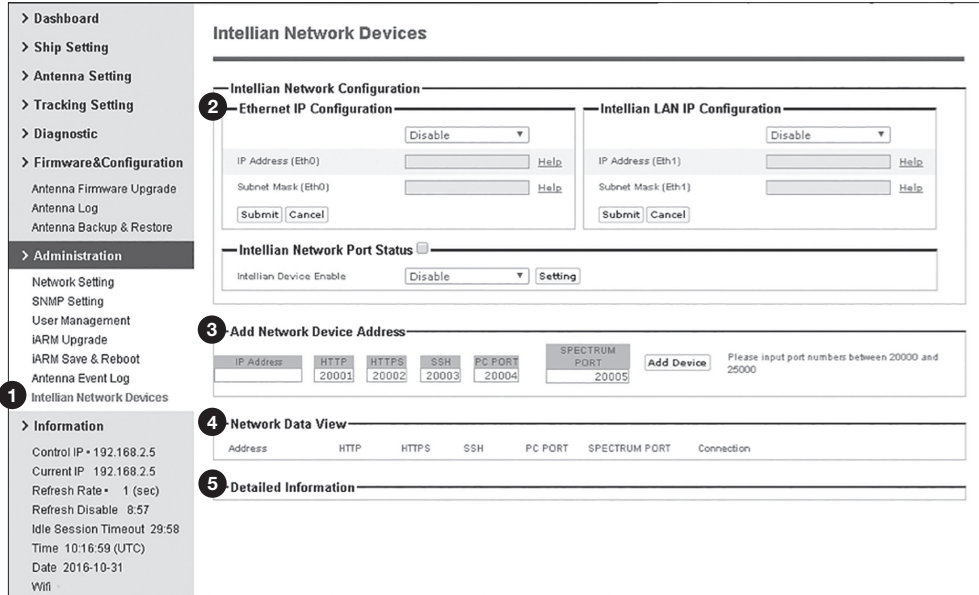

No.	Item	Description
①	Intellian Network Devices	Add up to 8 network devices and enable to monitor real time information of the connected devices.
②	Network Configuration	<ul style="list-style-type: none"> Eth0 IP Configuration: ACU network Eth0 IP and subnet mask setting. Eth1 IP Configuration: ACU network Eth1 IP and subnet mask setting. Intellian Network Port Status: not used on t-series.
③	Add Network Device Address	<p>Add Intellian network devices, then you can browse the various information of the device.</p> <ul style="list-style-type: none"> IP Address: IP address of the device to be monitored. HTTP, HTTPS, SSH: Set port number (These port numbers will be matched the http, https or SSH port number of each device).
④	Network Data View	<p>Displays the setting information of the added device (IP address, http, https, SSH port number, current connection). If you click the http/https port number of each device, then you can connect to the device's web page. If you click Delete Device button, then you can't see its information.</p>
⑤	Detailed Information	Displays the information of each device. (Updated every 3 seconds).

TECHNICAL SPECIFICATION

General		
Approvals		
CE – conforms to	EU Directive 89/336/EEC	
FCC – verified to	CFR47: Part 15	
Dimensions		
Satellite antenna unit	1380mm x 1520mm (54.33"x59.84")	
Antenna dish diameter	1090mm (42.9")	
Antenna control unit	431mm x 381mm x 44mm (17" x 15" x 1.7")	
Weight		
Satellite antenna unit	96kg (211.6lbs)	
Antenna control unit	3.5kg (7.7 lbs)	
Antenna system performance		
Antenna Type	Cassegrain type	
Size	1090mm (42.9")	
Polarization	Ku-band: Linear/Circular Switchable Ka-band: Circular	
Frequency	Ku-band: 10.7 ~ 12.75 GHz Ka-band: 18.3 ~ 18.8 / 19.7 ~ 20.2GHz	
Minimum EIRP	Ku-band: 42 dBW Ka-band: 45 dBW	
Axis	Three Axis: Azimuth, Elevation, Cross-level, Auto Skew	
Positioning	3-axis Velocity Mode Servo Control: Azimuth, Elevation, and Cross-Level	
Tracking Rates	Roll/Pitch/Yaw	±25° roll, ±15° pitch, ±8° yaw @ 6sec period
	Turning	Up to 12°/sec, 5°/sec ²
	Azimuth	690°
Range of Motion	Elevation	-15° to 120°
	Cross Level	±37°
	Stabilization Accuracy	0.2° max in presence of specified ship motions
LNB	WorldView™ Trio LNB (Ka and programmable Ku World-View LNB)	
LO Frequency	Ku-band: 9.75/10.6 GHz (Universal mode), 10.5, 10.678, 10.7, 10.75, 11.25 and 11.3 GHz (Single mode) Ka-band: 18.05 GHz	

Antenna Control Unit (BP-TA51)		
Size	431mm x 381mm x 44mm (17" x 15" x 1.7")	
Weight	3.5kg (7.7 lbs)	
Display	2 Line 40 Character Graphic VFD Module	
User Control Key	20 touch keys	
Gyrocompass Interface	NMEA 2000 / NMEA 0183	
GPS Interface	Built-In (NMEA 0183 GPS)	
PC Interface	RS232C (57600bps 8, N, 1) / USB	
Remote Access	TCP / IP, Wi-Fi (Range: ~120 meters)	
Ethernet Port	2 x RJ45 (Front 1, Rear 1)	
RF Interface	Antenna Interface	F - Type
	STB Interface	F - Type
Power Requirement	100 ~ 240 V AC, 50~60Hz, 2A	
Power Consumption	Typ. 50W, Max 100W	
Multi Switch Module		
Size	431mm x 381mm x 44mm (17" x 15" x 1.7")	
Weight	4.0kg (8.8 lbs)	
User Control Key	Power On/Off Key	
Connector	Antenna Interface: F-Type (RF1~RF4) SWM compatible STB Interface: F-Type (SWM1, SWM2) Universal STB Interface: F-Type (OUT1~8)	
Power Requirements	100 ~ 240 VAC, 50~60Hz, 4A	

NOTE: The color code for the Intellian radome and base is Intellian White (Intellian code: UP2578) only for Intellian products. The closest color it is RAL9001 (See information below). When applying the paint, compare it using the radome sample.

Refer to the link: <http://www.ralcolor.com>
 RAL: RAL 9001
 RGB (approx.): 250-244-227
 HEX: #FDF4E3
 English: Cream

WARRANTY

This product is warranted by Intellian Technologies Inc., to be free from defects in materials and workmanship for a period of THREE (3) YEARS on parts and TWO (2) YEARS on labor performed at Intellian Technologies, Inc. service center from the purchased date of the product.

Intellian Technologies, Inc. warranty does not apply to product that has been damaged and subjected to accident, abuse, misuse, non-authorized modification, incorrect and/ or non-authorized service, or to a product on which the serial number has been altered, mutilated or removed.

It is required to present a copy of the purchase receipt issued by Intellian Technologies, Inc. that indicates the date of purchase for after-sales service under the warranty period. In case of failure to present the purchase receipt, the warranty period will begin 30 days after the manufacturing production date of the product purchased.

Any product which is proven to be defective in materials or workmanship, Intellian Technologies, Inc. will (at its sole option) repair or replace during the warranty period in accordance with this warranty. All products returned to Intellian Technologies, Inc. under the warranty period must be accompanied by a return material authorization (RMA) number issued by the dealer/distributor from Intellian Technologies, Inc. and a copy of the purchase receipt as a proof of purchased date, prior to shipment. Alternatively, you may bring the product to an authorized Intellian Technologies, Inc. dealer/distributor for repair.